



IBM System Storage SAN Volume Controller and Storwize V7000 Command-Line Interface User's Guide

Version 6.2.0

GC27-2287-01





IBM System Storage SAN Volume Controller and Storwize V7000 Command-Line Interface User's Guide

Version 6.2.0

GC27-2287-01

Note

Before using this information and the product it supports, read the information in “Notices” on page 511.

This edition applies to the IBM System Storage SAN Volume Controller, Version 6.2.0, and the IBM Storwize V7000, Version 6.2.0, and to all subsequent releases and modifications until otherwise indicated in new editions.

This edition replaces GC27-2287-00. .

© **Copyright IBM Corporation 2003, 2011.**

US Government Users Restricted Rights – Use, duplication or disclosure restricted by GSA ADP Schedule Contract with IBM Corp.

Contents

Tables ix

About this guide. xi

Who should use this guide	xi
Summary of changes for GC27-2287-01 SAN Volume Controller Command-Line Interface User's Guide	xi
Emphasis	xvii
SAN Volume Controller library and related publications.	xvii
How to order IBM publications.	xx
Sending your comments	xx
Syntax diagrams	xxi
Terminology	xxii
CLI special characters	xxiii
Using wildcards in the SAN Volume Controller CLI	xxiii
Data types and value ranges	xxiv
CLI commands and parameters	xxviii
CLI flags	xxix
CLI messages	xxx
Attributes of the -filtervalue parameters	xxx

Chapter 1. Preparing the SSH client. 1

Preparing the SSH client on a Windows host	1
Generating an SSH key pair using PuTTY	2
Configuring a PuTTY session for the CLI.	3
Connecting to the CLI using PuTTY	3
Starting a PuTTY session for the CLI	5
Preparing the SSH client on an AIX or Linux host	6
Generating an SSH key pair using OpenSSH.	7
Connecting to the CLI using OpenSSH	7
Creating users	7

Chapter 2. Copying the SAN Volume Controller software upgrade files using PuTTY scp 9

Chapter 3. Using the CLI 11

Setting the clustered system time using the CLI	11
Viewing and updating license settings using the CLI	12
Displaying clustered system properties using the CLI	12
Maintaining passwords for the front panel using the CLI	13
Re-adding a repaired node to a clustered system using the CLI.	14
Displaying node properties using the CLI	17
Discovering MDisks using the CLI	18
Creating storage pools using the CLI	19
Adding MDisks to storage pools using the CLI	21
Setting a quorum disk using the CLI	22
Modifying the amount of available memory for Copy Services and VDisk Mirroring features using the CLI.	23

Creating volumes using the CLI	24
Adding a copy to a volume using the CLI	27
Deleting a copy from a volume using the CLI	28
Configuring host objects using the CLI	28
Creating volume-to-host mappings using the CLI.	29
Creating FlashCopy mappings using the CLI	29
Preparing and starting a FlashCopy mapping using the CLI.	30
Stopping FlashCopy mappings using the CLI	31
Deleting a FlashCopy mapping using the CLI	32
Creating a FlashCopy consistency group and adding mappings using the CLI	32
Preparing and starting a FlashCopy consistency group using the CLI	33
Stopping a FlashCopy consistency group using the CLI.	34
Deleting a FlashCopy consistency group using the CLI.	35
Creating Metro Mirror or Global Mirror relationships using the CLI	35
Modifying Metro Mirror or Global Mirror relationships using the CLI	35
Starting and stopping Metro Mirror or Global Mirror relationships using the CLI.	36
Displaying the progress of Metro Mirror or Global Mirror relationships using the CLI	36
Switching Metro Mirror or Global Mirror relationships using the CLI	37
Deleting Metro Mirror and Global Mirror relationships using the CLI	37
Creating Metro Mirror or Global Mirror consistency groups using the CLI	37
Modifying Metro Mirror or Global Mirror consistency groups using the CLI	37
Starting and stopping Metro Mirror or Global Mirror consistency-group copy processes using the CLI.	38
Deleting Metro Mirror or Global Mirror consistency groups using the CLI	38
Creating Metro Mirror and Global Mirror partnerships using the CLI	39
Modifying Metro Mirror and Global Mirror partnerships using the CLI	39
Starting and stopping Metro Mirror and Global Mirror partnerships using the CLI.	39
Deleting Metro Mirror and Global Mirror partnerships using the CLI	40
Determining the WWPNS of a node using the CLI	40
Listing node-dependent volumes using the CLI	40
Determining the VDisk name from the device identifier on the host	41
Determining the host that a VDisk (volume) is mapped to.	42
Determining the relationship between volumes and MDisks using the CLI	42

Determining the relationship between MDisks and controller LUNs using the CLI	42
Increasing the size of your clustered system using the CLI	43
Adding a node to increase the size of a clustered system using the CLI	43
Migrating a volume to a new I/O group using the CLI	44
Validating and repairing mirrored volume copies using the CLI	45
Repairing a space-efficient volume using the CLI	46
Recovering from offline volumes using the CLI	47
Recovering a node and returning it to the clustered system using the CLI	47
Recovering offline volumes using the CLI	48
Moving offline volumes to their original I/O group using the CLI	49
Recording WWPN changes of replaced host HBAs	49
Expanding VDisks (volumes) using the CLI	50
Expanding a VDisk (volume) that is mapped to an AIX host	51
Expanding a volume that is mapped to a Microsoft Windows host using the CLI	51
Shrinking a volume using the CLI	52
Migrating extents using the CLI	53
Migrating volumes between storage pools using the CLI	54
Migrating a volume between I/O groups using the CLI	55
Creating an image mode volume using the CLI	56
Migrating data to an image mode virtual disk using the CLI	57
Deleting a node from a clustered system using the CLI	57
Performing the clustered system maintenance procedure using the CLI	59
Modifying the cluster (system) IP addresses using the CLI	60
Changing the clustered system gateway address using the CLI	61
Changing the relationship bandwidth for a clustered system using the CLI	61
Configuring the clustered system for iSCSI using the CLI	61
Configuring or modifying an iSCSI alias using the CLI	63
Configuring the iSNS server address using the CLI	63
Configuring clustered system iSCSI authentication using the CLI	64
Configuring remote authentication service using CLI	64
Creating and working with user groups using the CLI	65
Creating and working with users using the CLI	66
Setting up SNMP notifications using the CLI	67
Setting up syslog notifications using the CLI	68
Setting up email event notifications and inventory reports using the CLI	69
Setting up email servers using the CLI	70
Changing clustered system passwords using the CLI	70
Changing the locale setting using the CLI	70

Viewing the feature log using the CLI	71
Analyzing the error log using the CLI	71
Shutting down a clustered system using the CLI	71
Upgrading the software automatically using the CLI	72

Chapter 4. Overview of the dumps commands 75

Chapter 5. Array commands 77

charray	77
charraymember	77
lsarray	79
lsarrayinitprogress	82
lsarraylba	83
lsarraymember	84
lsarraymembergoals	86
lsarraymemberprogress	88
lsarraysyncprogress	89
mkarray	90
recoverarray	91
recoverarraybycluster	91
rmarray	92

Chapter 6. Audit log commands 93

catauditlog	93
dumpauidlog	94
lsauidlogdumps (Deprecated)	95

Chapter 7. Backup and restore commands 97

backup	97
clear	97
help	98
restore	99

Chapter 8. Clustered system commands 101

addnode	102
cfgportip	104
chcluster	105
chclusterip	108
chiogrp	110
chnode	112
chnodehw	113
cleardumps	114
cpdumps	115
detectmdisk	117
ping	118
rmnode	118
rmportip	121
setclustertime	121
setpwdreset	122
settimezone	123
startstats	123
stopcluster	125
stopstats (Deprecated)	126

Chapter 9. Clustered system diagnostic and service-aid commands 127

applysoftware	127
caterrlog (Deprecated)	128
caterrlogbyseqnum (Deprecated)	128
cherrstate	128
clearerrlog	129
dumperrlog	129
finderr	130
lserrlogbyfcconsistgrp (Deprecated)	131
lserrlogbyfcmap (Deprecated)	131
lserrlogbyhost (Deprecated)	131
lserrlogbyiogrp (Deprecated)	131
lserrlogbymdisk (Deprecated)	131
lserrlogbymdiskgrp (Deprecated)	131
lserrlogbynode (Deprecated)	131
lserrlogbyrconsistgrp (Deprecated)	131
lserrlogbyrrelationship (Deprecated)	131
lserrlogbyvdisk (Deprecated)	131
lserrlogdumps (Deprecated)	131
lseventlog	131
lssyslogserver	135
setlocale	136
svqueryclock	137
writesernum	137

Chapter 10. Controller command 139

chcontroller	139
------------------------	-----

Chapter 11. Drive commands. 141

applydrivesoftware	141
chdrive	141
lsdrive	142
lsdrivelba	144
lsdriveprogress	145
triggerdrivedump	146

Chapter 12. Email and event notification commands 147

chemail	148
chemailserver	149
chemailuser	150
chsnmpserver	151
chsyslogserver	152
mkemailserver	153
mkemailuser	154
mksnmpserver	155
mksyslogserver	157
rmemailserver	158
rmemailuser	158
rmsnmpserver	159
rmsyslogserver	159
sendinventoryemail	160
startemail	160
stopemail	161
testemail	161

Chapter 13. Enclosure commands 163

addcontrolenclosure	163
chenclosure	163
chenclosurecanister	164
chenclosureslot	165

lseclosure	166
lseclosurebattery	168
lscontrolenclosurecandidate	169
lseclosurecanister	170
lseclosurepsu	172
lseclosureslot	173
triggerenclosuredump	175

Chapter 14. Licensing commands 177

chlicense	177
dumpinternallog	179

Chapter 15. IBM FlashCopy commands 181

chfcconsistgrp	181
chfcmap	181
mkfcconsistgrp	183
mkfcmap	184
prestartfcconsistgrp	186
prestartfcmap	187
rmfcconsistgrp	188
rmfcmap	189
startfcconsistgrp	190
startfcmap	191
stopfcconsistgrp	192
stopfcmap	194

Chapter 16. Host commands 197

addhostiogrp	197
addhostport	197
chhost	198
mkhost	199
rmhost	201
rmhostiogrp	202
rmhostport	203

Chapter 17. Information commands 205

ls2145dumps (Deprecated)	205
lscimomdumps (Deprecated)	205
lscopystatus	205
lscluster	206
lsclustercandidate	210
lsclusterip	211
lscontroller	213
lscontrollerdependentvdisk	215
lscurrentuser	216
lsdiscoverystatus	216
lsdumps	217
lsemailer	219
lsemaileruser	220
lsfabric	221
lsfcconsistgrp	222
lsfcmap	224
lsfcmapcandidate	226
lsfcmapprogress	227
lsfcmapdependentmaps	228
lsfeaturedumps (Deprecated)	229
lsfreeextents	229
lshbaportcandidate	230
lshost	231

lshostiogrp	233
lshostvdiskmap	234
lsiogrp	235
lsiogrphost	237
lsiogrpcandidate	238
lsiostatsdumps (Deprecated)	239
lsiotracedumps (Deprecated)	239
lsciscsiauth	239
lslicense	240
lsmdisk	241
lsmdiskdumps (Deprecated)	245
lsmdisklba	246
lsmdiskcandidate	247
lsmdiskextent	248
lsmdiskgrp	250
lsmdiskmember	253
lsmigrate	255
lsnode	256
lsnodehw	260
lsnodecandidate	261
lsnodedependentvdisks (Deprecated)	263
lsnodestats	263
lsnodevdpd	264
lsportip	268
lsquorum	270
lsrconsistgrp	271
lsrrelationship	274
lsrrelationshipcandidate	276
lsrrelationshipprogress	277
lsrepairsevdiskcopyprogress	278
lsrepairvdiskcopyprogress	279
lsrmvdiskdependentmaps	281
lsroute	282
lssevdiskcopy	282
lssnmpserver	285
lssoftwaredumps (Deprecated)	286
lssoftwareupgradestatus	287
lstimezones	287
lsuser	288
lsusergrp	289
lsvdisk	290
lsvdiskcopy	296
lsvdiskdependentmaps	299
lsvdiskextent	300
lsvdiskfcmapcopies	301
lsvdiskfc mappings	302
lsvdiskhostmap	302
lsvdisklba	303
lsvdiskmember	305
lsvdiskprogress	307
lsvdisksyncprogress	307
lsdependentvdisks	308
lssasfabric	309
showtimezone	311
Chapter 18. livedump commands	313
cancelledump	313
lslivedump	313
preplivedump	314
triggerlivedump	314

Chapter 19. Managed disk commands	317
applymdisksoftware (Discontinued)	317
chmdisk	317
chquorum	317
dumpallmdiskbadblocks	319
dumpmdiskbadblocks	320
includemdisk	321
setquorum (Deprecated)	322
triggermdiskdump (Discontinued)	322

Chapter 20. Managed disk group commands	323
addmdisk	323
chmdiskgrp	324
mkmdiskgrp	325
rmmdisk	327
rmmdiskgrp	328

Chapter 21. Metro Mirror and Global Mirror commands	331
chpartnership	331
chrconsistgrp	332
chrrelationship	332
mkpartnership	334
mkrconsistgrp	335
mkrrelationship	335
rmpartnership	338
rmrconsistgrp	338
rmrrelationship	339
startrrconsistgrp	340
startrrrelationship	342
stoprrconsistgrp	344
stoprrrelationship	345
switchrrconsistgrp	346
switchrrrelationship	347

Chapter 22. Migration commands	349
migrateexts	349
migratetoimage	350
migratevdisk	351

Chapter 23. Service information commands	353
lscmdstatus	353
lsfiles	353
lshardware	354
lsservicenodes	357
lsservicerecommendation	358
lsservicestatus	359

Chapter 24. Service mode commands (Discontinued)	365
applysoftware (Discontinued)	365
cleardumps (Discontinued)	365
dumpperlog (Discontinued)	365
exit (Discontinued)	365

Chapter 25. Service mode information commands (Discontinued) **367**

ls2145dumps (Discontinued) 367
lscimomdumps (Discontinued) 367
lsclustervpd (Discontinued). 367
lserrlogdumps (Discontinued) 367
lsfeaturedumps (Discontinued) 367
lsiostatsdumps (Discontinued). 367
lsiotracedumps (Discontinued) 367
lsmdiskdumps (Discontinued). 367
lsnodevpd (Discontinued) 367
lssoftwaredumps (Discontinued) 368

Chapter 26. Service task commands **369**

chenclosurevpd. 369
chnodeled 370
chserviceip 370
chwwnn 372
cpfiles 372
installsoftware 373
leavecluster 374
metadata 374
mkcluster. 375
rescuenode 376
resetleds 377
resetpassword 377
restartservice 377
snap 378
setpacedccu 378
settempsshkey 379
startservice 379
stopnode 380
stopservice 380
t3recovery 381

Chapter 27. Tracing commands. **383**

setdisktrace 383
settrace 383
starttrace 385
stoptrace 386

Chapter 28. User management commands **387**

chauthservice 387
chcurrentuser 389
chuser 390
chusergrp 391
mkuser 392
mkusergrp 393
rmuser 394
rmusergrp 394

Chapter 29. Virtual disk commands **397**

addvdiskcopy 397
chvdisk 401
expandvdisksize 404
mkvdisk 406
mkvdiskhostmap 413
recovervdisk. 414
recovervdiskbycluster 415
recovervdiskbyiogrp 415
repairsevdiskcopy 416
repairvdiskcopy 417
rmvdisk 418
rmvdiskcopy 419
rmvdiskhostmap 420
shrinkvdisksize 421
splitvdiskcopy 423

Chapter 30. Command-line interface messages **425**

Appendix. Accessibility **509**

Notices **511**

Trademarks 513

Index **515**

Tables

1.	Terminology mapping table for version 6.2.0	xi
2.	SAN Volume Controller library	xviii
3.	Other IBM publications	xix
4.	IBM documentation and related websites	xx
5.	Valid filter attributes	xxx
6.	Maximum volume capacity by extent size	20
7.	Memory required for VDisk Mirroring and Copy Services	23
8.	RAID level comparisons	24
9.	Volume copy resynchronization rates	25
10.	charraymember combination options	78
11.	MDisk output	81
12.	lsarrayinitprogress output	83
13.	lsarraylba output	84
14.	lsarraymemberoutput	85
15.	lsarraymembergoals output	87
16.	lsarraymemberprogress output	88
17.	lsarraysyncprogress output	89
18.	ip_address_list formats	109
19.	Memory required for VDisk Mirroring and Copy Services	111
20.	RAID level comparisons	112
21.	lseventlog output	132
22.	lsdrive output	143
23.	lsdrivelba output	145
24.	lsclosure output	166
25.	lsclosurebattery outputs	168
26.	lscontrolenclosurecandidate attribute values	169
27.	lsclosurecanister output	170
28.	lsclosurepsu output	172
29.	lsclosureslot output	174
30.	Relationship between the <i>rate</i> , data rate and grains per second values	183
31.	Relationship between the <i>rate</i> , data rate and grains per second values	186
32.	Attribute values	207
33.	MDisk output	243
34.	lsmdisklba command output	247
35.	lsnode attribute values	257
36.	lsnode attribute values	257
37.	lsnodehw attribute values	260
38.	lsnodecandidate outputs	262
39.	lsnodecandidate outputs	262
40.	lsnodestats attribute values	263
41.	lsrcconsistgrp command output values	273
42.	lsrcrelationship command attributes and values	275
43.	lsvdisklba command output scenarios	304
44.	lssasfabric output	310
45.	lslivedump outputs	314
46.	Number of extents reserved by extent size	319
47.	stoprcconsistgrp consistency group states	344
48.	stoprcrelationship consistency group states	346
49.	lshardware attribute values	355
50.	lsservicenodes outputs	357
51.	lsservicenodes outputs	358
52.	lsservicestatus output	359
53.	lsservicestatus output	361
54.	Storage pool Easy Tier settings	399
55.	Relationship between the <i>rate</i> value and the data copied per second	400
56.	Storage pool Easy Tier settings	409
57.	Relationship between the <i>rate</i> value and the data copied per second	411

About this guide

This publication provides information that helps you configure and use the IBM® System Storage® SAN Volume Controller and IBM Storwize® V7000.

Who should use this guide

This guide is intended for system administrators or others who install and use the SAN Volume Controller or Storwize V7000.

Before you use the SAN Volume Controller, you should have an understanding of storage area networks (SANs), the storage requirements of your enterprise, and the capabilities of your storage units.

Summary of changes for GC27-2287-01 SAN Volume Controller Command-Line Interface User's Guide

This topic describes the changes that have been made to the SAN Volume Controller *Command-Line Interface User's Guide* since the previous edition (GC27-2287-00).

6.2.0 Terminology changes

To coincide with new and existing IBM products and functions, several common terms have changed and are incorporated in the SAN Volume Controller information. Certain SAN Volume Controller information, particularly command-line interface (CLI) documentation, remains primarily unchanged.

The following table shows the current and previous use of the changed common terms for version 6.2.0.

Table 1. Terminology mapping table for version 6.2.0

6.2.0 SAN Volume Controller term	Previous SAN Volume Controller term	Description
clustered system or system	cluster	A collection of nodes that are placed in pairs (I/O groups) for redundancy, which provide a single management interface.

New information

The following new commands have been added for this edition:

- addcontrolenclosure
- cancellivedump
- chnodehw
- lscontrolenclosurecandidate
- lshardware
- lslivedump
- lsnodcandidate
- lsnodestats
- preplivedump
- triggerlivedump

| **Changed commands**

| The following commands and topics have been updated for this edition:

- | • addnode
- | • chenclosurevdpd
- | • chiogrp
- | • lsdependentvdisks
- | • lsnode
- | • lsnodecandidate
- | • lsservicenodes
- | • mkarray
- | • mkfcmap
- | • mkrcrelationship
- | • prestartfcconsistgrp
- | • prestartfcmap
- | • restartservice
- | • rmvdisk
- | • startfcconsistgrp
- | • startfcmap
- | • startrcconsistgrp
- | • startrcrelationship
- | • stopfcconsistgrp
- | • stopfcmap
- | • switchconsistgrp
- | • switchrcrelationship

| **Changed topics**

| The following topics have been updated for this edition:

- | • You can access Secure Shell (SSH) with a SAN Volume Controller user name:
 - | – Chapter 1, “Preparing the SSH client,” on page 1
 - | – “Preparing the SSH client on a Windows host” on page 1
 - | – “Preparing the SSH client on an AIX or Linux host” on page 6
 - | – “Creating users” on page 7

| **Command prefix changes**

| The **svctask** and **svcinfo** command prefixes are no longer necessary when issuing a command. If you have existing scripts that use those prefixes, they will continue to function. You do not need to change the scripts.

| The following commands are affected by this change:

- | • addhostiogrp
- | • addhostport
- | • addhostport
- | • addmdisk
- | • addnode
- | • addvdiskcopy

- | • applydrivesoftware
- | • applysoftware
- | • catauditlog
- | • cfgportip
- | • charray
- | • charraymember
- | • chauthservice
- | • chcluster
- | • chclusterip
- | • chcontroller
- | • chcurrentuser
- | • chdrive
- | • chemail
- | • chemailserver
- | • chemailuser
- | • cherrstate
- | • chfcconsistgrp
- | • chfcmap
- | • chhost
- | • chiogrp
- | • chlicense
- | • chmdisk
- | • chmdiskgrp
- | • chnode
- | • chpartnership
- | • chquorum
- | • chrconsistgrp
- | • chrcrelationship
- | • chsnmpserver
- | • chsyslogserver
- | • chuser
- | • chusergrp
- | • chvdisk
- | • clear.dumps
- | • clearerrlog
- | • cp.dumps
- | • detectmdisk
- | • dumpallmdiskbadblocks
- | • dumpauditlog
- | • dumperrlog
- | • dumpinternallog
- | • dumpmdiskbadblocks
- | • expandvdisksize
- | • finderr
- | • includemdisk

- | • lsarray
- | • lsarrayinitprogress
- | • lsarraylba
- | • lsarraymember
- | • lsarraymembergoals
- | • lsarraymemberprogress
- | • lsarraysyncprogress
- | • lscluster
- | • lsclustercandidate
- | • lsclusterip
- | • lscontroller
- | • lscontrollerdependentvdisks
- | • lscopystatus
- | • lscurrentuser
- | • lsdependentvdisks
- | • lsdiscoverystatus
- | • lsdrive
- | • lsdrivelba
- | • lsdriveprogress
- | • lsdumps
- | • lsemailserver
- | • lsemailuser
- | • lseventlog
- | • lsfabric
- | • lsfcconsistgrp
- | • lsfcmap
- | • lsfcmapdependentmaps
- | • lsfcmapprogress
- | • lsfreeextents
- | • lshbaportcandidate
- | • lshost
- | • lshostiogrp
- | • lshostvdiskmap
- | • lsiogrp
- | • lsiogrpcandidate
- | • lsiogrphost
- | • lsiscsiauth
- | • lslicense
- | • lsmdisk
- | • lsmdiskcandidate
- | • lsmdiskextent
- | • lsmdiskgrp
- | • lsmdisklba
- | • lsmdiskmember
- | • lsmigrate

- | • lsnode
- | • lsnodecandidate
- | • lsnodevpd
- | • lspointip
- | • lsquorum
- | • lsrrconsistgrp
- | • lsrrrelationship
- | • lsrrrelationshipcandidate
- | • lsrrrelationshipprogress
- | • lsrepairsevdiskcopyprogress
- | • lsrepairvdiskcopyprogress
- | • lsrepairvdiskcopyprogress
- | • lsrmvdiskdependentmaps
- | • lsroute
- | • lssasfabric
- | • lssevdiskcopy
- | • lssnmpserver
- | • lssoftwareupgradestatus
- | • lssyslogserver
- | • lstimezones
- | • lsuser
- | • lsusergroup
- | • lsvdisk
- | • lsvdiskcopy
- | • lsvdiskdependentmaps
- | • lsvdiskextent
- | • lsvdiskfcmapcopies
- | • lsvdiskfcmappings
- | • lsvdiskhostmap
- | • lsvdisklba
- | • lsvdiskmember
- | • lsvdiskprogress
- | • lsvdisksyncprogress
- | • migrateexts
- | • migratetoimage
- | • migratevdisk
- | • mkarray
- | • mkemailserver
- | • mkemailuser
- | • mkfcconsistgrp
- | • mkfcmap
- | • mkhost
- | • mkmdiskgrp
- | • mkpartnership
- | • mkrconsistgrp

- | • mkrcrelationship
- | • mksnmpserver
- | • mksyslogserver
- | • mkuser
- | • mkusergrp
- | • mkvdisk
- | • mkvdiskhostmap
- | • prestartfcconsistgrp
- | • prestartfcmap
- | • recoverarray
- | • recoverarraybycluster
- | • recovervdisk
- | • recovervdiskbycluster
- | • recovervdiskbyiogrp
- | • repairsevdiskcopy
- | • repairvdiskcopy
- | • resetleds
- | • rmarrray
- | • rmemailserver
- | • rmemailuser
- | • rmfcconsistgrp
- | • rmfcmap
- | • rmhost
- | • rmhostiogrp
- | • rmhostport
- | • rmmdisk
- | • rmmdiskgrp
- | • rmnode
- | • rmpartnership
- | • rmportip
- | • rmrconsistgrp
- | • rmrcrelationship
- | • rmsnmpserver
- | • rmuser
- | • rmusergrp
- | • rmvdisk
- | • rmvdiskcopy
- | • rmvdiskhostmap
- | • rmvdiskhostmap
- | • sendinventoryemail
- | • setclustertime
- | • setdisktrace
- | • setlocale
- | • setpwdreset
- | • settimezone

- | • settrace
- | • showtimezone
- | • shrinkvdisksize
- | • splitvdiskcopy
- | • startemail
- | • startfcconsistgrp
- | • startfcmap
- | • startrcconsistgrp
- | • startrcrelationship
- | • startstats
- | • starttrace
- | • stopcluster
- | • stopemail
- | • stopfcconsistgrp
- | • stopfcmap
- | • stopfcmap
- | • stoprcconsistgrp
- | • stoprcrelationship
- | • stoptrace
- | • switchrcconsistgrp
- | • switchrcrelationship
- | • testemail
- | • triggerdrivedump
- | • writesernum

Emphasis

Different typefaces are used in this guide to show emphasis.

The following typefaces are used to show emphasis:

Boldface	Text in boldface represents menu items.
Bold monospace	Text in bold monospace represents command names.
<i>Italics</i>	Text in <i>italics</i> is used to emphasize a word. In command syntax, it is used for variables for which you supply actual values, such as a default directory or the name of a system.
Monospace	Text in monospace identifies the data or commands that you type, samples of command output, examples of program code or messages from the system, or names of command flags, parameters, arguments, and name-value pairs.

SAN Volume Controller library and related publications

Product manuals, other publications, and websites contain information that relates to SAN Volume Controller.

SAN Volume Controller Information Center

The IBM System Storage SAN Volume Controller Information Center contains all of the information that is required to install, configure, and manage the SAN Volume Controller. The information center is updated between SAN Volume Controller product releases to provide the most current documentation. The information center is available at the following website:

publib.boulder.ibm.com/infocenter/svc/ic/index.jsp

SAN Volume Controller library

Unless otherwise noted, the publications in the SAN Volume Controller library are available in Adobe portable document format (PDF) from the following website:

Support for SAN Volume Controller (2145) website at www.ibm.com/storage/support/2145

Each of the PDF publications in Table 2 is available from this Information Center by clicking the number in the "Order number" column:

Table 2. SAN Volume Controller library

Title	Description	Order number
<i>IBM System Storage SAN Volume Controller Model 2145-CG8 Hardware Installation Guide</i>	This guide provides the instructions that the IBM service representative uses to install the hardware for SAN Volume Controller model 2145-CG8.	GC27-3923
<i>IBM System Storage SAN Volume Controller Hardware Maintenance Guide</i>	This guide provides the instructions that the IBM service representative uses to service the SAN Volume Controller hardware, including the removal and replacement of parts.	GC27-2283
<i>IBM System Storage SAN Volume Controller Troubleshooting Guide</i>	This guide describes the features of each SAN Volume Controller model, explains how to use the front panel, and provides maintenance analysis procedures to help you diagnose and solve problems with the SAN Volume Controller.	GC27-2284
<i>IBM System Storage SAN Volume Controller Software Installation and Configuration Guide</i>	This guide provides guidelines for configuring your SAN Volume Controller. Instructions for backing up and restoring the cluster configuration, using and upgrading the management GUI, using the CLI, upgrading the SAN Volume Controller software, and replacing or adding nodes to a cluster are included.	GC27-2286
<i>IBM System Storage SAN Volume Controller CIM Agent Developer's Guide</i>	This guide describes the concepts of the Common Information Model (CIM) environment. Procedures describe such tasks as using the CIM agent object class instances to complete basic storage configuration tasks, establishing new Copy Services relationships, and performing CIM agent maintenance and diagnostic tasks.	GC27-2288

Table 2. SAN Volume Controller library (continued)

Title	Description	Order number
<i>IBM System Storage SAN Volume Controller Safety Notices</i>	This guide contains translated caution and danger statements. Each caution and danger statement in the SAN Volume Controller documentation has a number that you can use to locate the corresponding statement in your language in the <i>IBM System Storage SAN Volume Controller Safety Notices</i> document.	GA32-0844
<i>IBM System Storage SAN Volume Controller Read First Flyer</i>	This document introduces the major components of the SAN Volume Controller system and describes how to get started installing the hardware and software.	GA32-0843
<i>IBM System Storage SAN Volume Controller and IBM Storwize V7000 Command-Line Interface User's Guide</i>	This guide describes the commands that you can use from the SAN Volume Controller command-line interface (CLI).	GC27-2287
<i>IBM Environmental Notices and User Guide</i>	This multilingual guide describes environmental policies to which IBM products adhere, as well as how to properly recycle and dispose of IBM products and the batteries within IBM hardware products. Notices within the guide describe flat panel displays, refrigeration, water cooling systems, and external power supplies.	Z125-5823
<i>IBM Statement of Limited Warranty</i>	This multilingual document provides information about the IBM warranty for the SAN Volume Controller product.	Part number: 85Y5978
<i>IBM License Agreement for Machine Code</i>	This multilingual guide contains the License Agreement for Machine Code for the SAN Volume Controller product.	Z125-5468

Other IBM publications

Table 3 lists IBM publications that contain information related to the SAN Volume Controller.

Table 3. Other IBM publications

Title	Description	Order number
<i>IBM System Storage Productivity Center Introduction and Planning Guide</i>	This guide introduces the IBM System Storage Productivity Center hardware and software.	SC23-8824
<i>Read This First: Installing the IBM System Storage Productivity Center</i>	This guide describes how to install the IBM System Storage Productivity Center hardware.	GI11-8938

Table 3. Other IBM publications (continued)

Title	Description	Order number
<i>IBM System Storage Productivity Center User's Guide</i>	This guide describes how to configure the IBM System Storage Productivity Center software.	SC27-2336
<i>IBM System Storage Multipath Subsystem Device Driver User's Guide</i>	This guide describes the IBM System Storage Multipath Subsystem Device Driver for IBM System Storage products and how to use it with the SAN Volume Controller.	GC52-1309

IBM documentation and related websites

Table 4 lists websites that provide publications and other information about the SAN Volume Controller or related products or technologies.

Table 4. IBM documentation and related websites

Website	Address
Support for SAN Volume Controller (2145)	Support for SAN Volume Controller (2145) website at www.ibm.com/storage/support/2145
Support for IBM System Storage and IBM TotalStorage products	www.ibm.com/storage/support/
IBM Publications Center	www.ibm.com/e-business/linkweb/publications/servlet/pbi.wss
IBM Redbooks® publications	www.redbooks.ibm.com/

Related accessibility information

To view a PDF file, you need Adobe Acrobat Reader, which can be downloaded from the Adobe website:

www.adobe.com/support/downloads/main.html

How to order IBM publications

The IBM Publications Center is a worldwide central repository for IBM product publications and marketing material.

The IBM Publications Center offers customized search functions to help you find the publications that you need. Some publications are available for you to view or download at no charge. You can also order publications. The publications center displays prices in your local currency. You can access the IBM Publications Center through the following website:

www.ibm.com/e-business/linkweb/publications/servlet/pbi.wss

Sending your comments

Your feedback is important in helping to provide the most accurate and highest quality information.

To submit any comments about this book or any other SAN Volume Controller documentation:

- Go to the feedback page on the website for the SAN Volume Controller Information Center at publib.boulder.ibm.com/infocenter/svc/ic/index.jsp?topic=/com.ibm.storage.svc.console.doc/

feedback.htm. There you can use the feedback page to enter and submit comments or browse to the topic and use the feedback link in the running footer of that page to identify the topic for which you have a comment.

- Send your comments by email to starpubs@us.ibm.com. Include the following information for this publication or use suitable replacements for the publication title and form number for the publication on which you are commenting:
 - Publication title: *IBM System Storage SAN Volume Controller and IBM Storwize V7000 Command-Line Interface User's Guide*
 - Publication form number: GC27-2287-01
 - Page, table, or illustration numbers that you are commenting on
 - A detailed description of any information that should be changed

Syntax diagrams

A syntax diagram uses symbols to represent the elements of a command and to specify the rules for using these elements.

The following table explains how to read the syntax diagrams that represent the command-line interface (CLI) commands. In doing so, it defines the symbols that represent the CLI command elements.

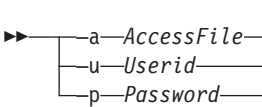
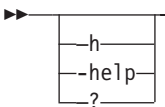
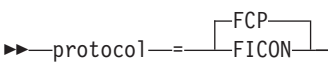
Element	Syntax	Description
Main path line	>>><>() ()	>>Begins on the left with double arrowheads (>>) and ends on the right with two arrowheads facing each other (()). If a diagram is longer than one line, each line to be continued ends with a single > arrowhead (>) and the next line begins with a single arrowhead (>). Read the diagrams from left-to-right, top-to-bottom, following the main path line.
Keyword	▶▶—esscli—▶▶	Represents the name of a command, flag, parameter, or argument. A keyword is not in italics. Spell a keyword exactly as it is shown in the syntax diagram.
Required keywords	▶▶ 	Indicate the parameters or arguments that you must specify for the command. Required keywords appear on the main path line. Required keywords that cannot be used together are stacked vertically.
Optional keywords	▶▶ 	Indicate the parameters or arguments that you can choose to specify for the command. Optional keywords appear below the main path line. Mutually exclusive optional keywords are stacked vertically.
Default value	▶▶—protocol—=  ▶▶	Appears above the main path line.

Element	Syntax	Description
Repeatable keyword or value		Represents a parameter or argument that you can specify more than once. A repeatable keyword or value is represented by an arrow returning to the left above the keyword or value.
Variable		Represents the value that you need to supply for a parameter or argument, such as a file name, user name, or password. Variables are in italics.
Space separator		Adds a blank space on the main path line to separate keywords, parameters, arguments, or variables from each other.
Quotation mark delimiters		Indicates the start and end of a parameter or argument that contains multiple values. Enclose one or more name-value pairs in a set of double quotation marks for a particular parameter or argument. If the value of a parameter or name-value pair contains a blank or white space, enclose the entire value in a set of single quotation marks.
Equal-sign operator		Separates a name from its value in a name-value pair.
Syntax fragment		Breaks up syntax diagrams that are too long, too complex, or repetitious. The fragment name is inserted in the main diagram, and the actual fragment is shown below the main diagram.

Terminology

These are abbreviations that are most commonly used for the command-line interface operations.

Name	Object type
Host	host
Virtual disk (volume)	vdisk
Virtual disk copy	vdiskcopy
Space-efficient (thin-provisioned) virtual disk copy	sevdiskcopy
Managed disk	mdisk
Managed disk group (storage pool)	mdiskgrp
I/O group	iogrp
Node	node
Cluster	clustered system (system)

Name	Object type
Controller	controller
IBM FlashCopy® mapping	fcmap
FlashCopy consistency group	fcconsistgrp
Metro Mirror or Global Mirror relationship	rcrelationship
Metro Mirror or Global Mirror consistency group	rcconsistgrp
Unsupported/unknown object	unknown

CLI special characters

The following special characters are used in the command-line interface (CLI) command examples.

minus (-) sign

Flags are prefixed with a - (minus) sign. Flags define the action of a command or modify the operation of a command. You can use multiple flags, followed by parameters, when you issue a command. The - character cannot be used as the first character of an object name.

vertical bar (|)

A vertical bar signifies that you choose only one value. For example, [a | b] in brackets indicates that you can choose a, b, or nothing. Similarly, { a | b } in braces indicates that you must choose either a or b.

Using wildcards in the SAN Volume Controller CLI

You can use wildcards in the SAN Volume Controller Command-Line Interface.

The SAN Volume Controller supports the use of the asterisk character (*) as a wildcard within the arguments of certain parameters. There are some behavioral issues that must be considered when using wildcards in order to prevent unexpected results. These behavioral issues and the ways to avoid them are as follows:

1. Running the command while logged onto the node.

The shell will attempt to interpret any of the special characters if they are not escaped (preceded with a backslash character). Wildcards will be expanded into a list of files if any files exist that match the wildcards. If no matching files exist, the wildcard is passed to the SAN Volume Controller command untouched.

To prevent expansion, issue the following command in one of its formats:

cleardumps -prefix '/dumps/*.txt' with single quotation marks ('), or

cleardumps -prefix /dumps/*.txt using a backslash (\), or

cleardumps -prefix "/dumps/*.txt" with double quotation marks ("").

2. Running the command through Secure Shell (SSH), for example from a host.

This method is slightly more complicated because the host shell processes the command line before it is passed through SSH to the shell on the clustered system (system). This means an extra layer of protection is required around the wildcard as the host shell will strip off any protecting quotes, and if the wildcard is exposed to the system shell, this will result in the wildcard being expanded in the system shell.

To prevent expansion, issue the following command in one of its formats:

`cleardumps "/dumps/*.txt"` with single quotation marks (') inside of double quotation marks ("), or

`cleardumps '/dumps/*.txt'` using a backslash (\) inside of single quotation marks ('), or

`cleardumps ""/dumps/*.txt""` with double quotation marks (") inside of single quotation marks (').

Data types and value ranges

The maximum length of any single parameter that is entered into the command line is 2176 bytes.

Note: If you do not specify a name when you are creating a new object, the clustered system (system) assigns a default -type name. The default -type name consists of the object prefix and an integer; for example, *vdisk23*. An object will be assigned a default name created from the object prefix and the lowest available integer starting from 0 (except for nodes that start from 1). The same default -type name must not already exist.

Data types	Value ranges
<code>filename_arg</code>	<p>This is a (optionally fully qualified) file name. The maximum length is 169 characters. Valid characters consist of the following options:</p> <ul style="list-style-type: none">• .• /• -• _• a - z• A - Z• 0 - 9 <p>The field must not contain two consecutive '.', or start with a '.', or end with a '.'.</p>

Data types	Value ranges
directory_or_file_filter	<p>Specifies a directory and file name filter, or both, within the specified directory. Valid directory values consist of the following options:</p> <ul style="list-style-type: none"> • /dumps • /dumps/audit • /dumps/configs • /dumps/elogs • /dumps/feature • /dumps/iostats • /dumps/iotrace • /dumps/software <p>The file name filter can be any valid file name with or without the wildcard '*'. The file name filter can be appended to the end of one of the previous directory values. The maximum length is 128 characters. Valid characters consist of the following options:</p> <ul style="list-style-type: none"> • * • . • / • - • _ • a - z • A - Z • 0 - 9 <p>The field must not contain two consecutive '.', or start with a '.', or end with a '!'.</p>
filename_prefix	<p>This is a prefix to be used when naming a file. The maximum length is 128 characters. Valid characters consist of the following options:</p> <ul style="list-style-type: none"> • a - z • A - Z • 0 - 9 • - • _
name_arg	<p>Names can be specified or changed using the create and modify functions. With the view commands you can see both the name and ID of an object.</p> <p>A string of 1 - 63 characters can be used, composed of characters A - Z, a - z, 0 - 9, - (dash), and _ (underscore).</p> <p>The first character of a <i>name_arg</i> must not be numeric. The first character of an object name cannot be a - (dash) because the CLI interprets it as being the next parameter.</p> <p>Valid characters are:</p> <ul style="list-style-type: none"> • a - z • A - Z • 0 - 9 • underscore (_) • hyphen (-) • period (.) • space () <p>The system name is set when the system is created.</p>

Data types	Value ranges
password	<p>This is a user-defined password. A password must meet the following requirements:</p> <ul style="list-style-type: none"> • Can use a - z, A - Z, 0 - 9 in any sequence • Can use - (dash) but not as the first character • Can use _ (underscore) • Can contain a maximum of 15 characters
serial_number	<p>The format of this number conforms to IBM standard C-S 1-1121-018 1999-06 Serial Numbering for IBM products. The serial number is 7 digits, the first two of which define the manufacturing location, leaving 5 digits for the product. The standard defines a way to extend the serial number using letters in the place of numbers in the 5-digit field.</p>
ip_address_arg	<p>The decimal, dotted-quad-notation standard rules. The following Internet Protocol 4 (IPv4) and Internet Protocol 6 (IPv6) address formats are supported:</p> <p>IPv4 (no port set, SAN Volume Controller uses default) 1.2.3.4</p> <p>IPv4 with specific port 1.2.3.4:22</p> <p>Full IPv6, default port 1234:1234:0001:0123:1234:1234:1234</p> <p>Full IPv6, default port, leading zeros suppressed 1234:1234:1:123:1234:1234:1234</p> <p>Full IPv6 with port [2002:914:fc12:848:209:6bff:fe8c:4ff6]:23</p> <p>Zero-compressed IPv6, default port 2002::4ff6</p> <p>Zero-compressed IPv6 with port [2002::4ff6]:23</p>
dns_name	<p>Dotted domain name for the subnet that the system is in. For example, ibm.com.</p>
hostname	<p>The host name that is assigned to the system. This can be different from the system name and you can change the host name at any time.</p> <p>A combination of the host name and the dns_name that is used to access the system, for example:</p> <p>https://hostname.ibm.com/</p>
capacity_value	<p>A value with a range of 512 bytes up to 2 petabytes (PB).</p> <p>Note: The capacity can be specified as megabytes (MB), kilobytes (KB), gigabytes (GB), or PB. When MB is used, the value is specified in multiples of 512 bytes. A capacity of 0 is valid for a striped or sequential volume. The smallest number of supported bytes is 512.</p>
node_id	<p>A node ID differs from other IDs; a node ID is a unique ID that is assigned when a node is used to create a system, or when a node is added to a system. A <i>node_id</i> value is never reused in a system. Node IDs are internally represented as 64-bit numbers.</p> <p>Node IDs, like other IDs, cannot be modified by user commands.</p>

Data types	Value ranges
xxx_id	<p>All objects are referred to by unique integer IDs that are assigned by the system when the objects are created. All IDs are represented internally as 32-bit integers. Node IDs are an exception.</p> <p>IDs in the following ranges are used to identify the various types of objects:</p> <ul style="list-style-type: none"> • node_id: A positive decimal integer greater than or equal to 1 • mdisk_grp_id: 0 - 127 • io_grp_id: 0 - 3 (See Note.) • mdisk_id: 0 - 4095 • vdisk_id: 0 - 8191 • copy_id: 0 - 1 • host_id: 0 - 1023 • flash_const_grp_id: 0 - 255 • remote_const_grp_id: 0 - 255 • fcmapi_id: 0 - 4095 • rcrel_id: 0 - 8191 • controller_id: 0 - 63 <p>Note: The io_group 4 exists but is used only in certain error recovery procedures.</p> <p>These IDs, like node IDs, cannot be modified by user commands.</p> <p>Note: IDs are assigned at run time by the system and cannot be relied upon to be the same after, for example, the configuration restoration. Use object names in preference to IDs when you are working with objects.</p>
xxx_list	A colon-delimited list of values of type <i>xxx</i> .
wwpn_arg	<p>The Fibre Channel worldwide port name (WWPN). This is expressed as a 64-bit hexadecimal number, for example:</p> <p>1A2B30C67AFFE47B</p> <p>These numbers must consist of the characters 0 - 9, a - f, and A - F. A command fails if you enter WWPN 0 in the command string.</p>
panel_name	A string of up to six characters that correspond to the number on the printed label below the display on the front panel of a node in the system.
sequence_number	A 32-bit unsigned integer, expressed in decimal format.
csi_num_arg	A 32-bit unsigned integer, expressed in decimal format.
percentage_arg	An 8-bit unsigned integer, expressed in decimal 0 - 100 format.
extent_arg	A 32-bit unsigned integer, expressed in decimal format.
num_extents_arg	A 32-bit unsigned integer, expressed in decimal format.
threads_arg	An 8-bit unsigned integer, expressed in decimal format. Valid values are 1, 2, 3, or 4.
velocity_arg	The fabric speed in gigabytes per second (GBps). Valid values are 1 or 2.
timezone_arg	The ID as detailed in the output of the lstimezones command.
timeout_arg	The command timeout period. An integer from 0 to 600 (seconds).
stats_time_arg	The frequency at which statistics are gathered. Valid values are 1 to 60 minutes in increments of 1 minute.

Data types	Value ranges
directory_arg	<p>Specifies a directory and or file name filter within the specified directory. The following directory values are valid:</p> <ul style="list-style-type: none"> • /dumps • /dumps/audit • /dumps/cimom • /dumps/configs • /dumps/elogs • /dumps/feature • /dumps/iostats • /dumps/iotrace • /home/admin/upgrade <p>The file name filter can be any valid file name with or without the wildcard '*'. The file name filter can be appended to the end of one of the previous directory values.</p>
locale_arg	<p>The system locale setting. Valid values are the following: .</p> <ul style="list-style-type: none"> • 0 en_US: US English (default) • 1 zh_CN: Simplified Chinese • 2 zh_TW: Traditional Chinese • 3 ja_JP: Japanese • 4 fr_FR: French • 5 de_DE: German • 6 it_IT: Italian • 7 es_ES: Spanish
key_arg	A user-defined identifier for an SSH key. It consists of a string of up to 30 characters.
user_arg	Specifies the user: either admin or service.
copy_rate	A numeric value of 0 - 100.
copy_type	Specifies the Mirror copy type: Metro or Global.

The maximum number of values that can be entered into a colon-separated list is 128. If more than 128 items are entered into a list, an error is returned.

CLI commands and parameters

CLI commands and parameters are represented in the syntax diagram.

The SAN Volume Controller command-line interface offers command line completion for command entry. Command line completion allows you to type in the first few characters of a command and press the Tab key to fill in the rest of the command name. If there are multiple commands that start with the same characters, then a list of possible commands is returned. You can type in more characters until the command name is unambiguous.

CLI parameters can be entered in any order except in the following situations:

- When a command name is specified, the first argument given must be the action that you want to be performed.
- Where you are performing an action against a specific object, the object ID or name must be the last argument in the line.

A valid parameter meets the following requirements:

- Parameters can be entered in any order.
- If a parameter has an associated argument, the argument must *always* follow the parameter.
- A parameter *must* start with a '-'; otherwise, it is assumed to be an argument.
- The maximum length of any single parameter that can be entered into the CLI is 128 bytes.
- An argument can contain multiple data items. The maximum number of data items that you can enter into such a list is 128. For a component list, separate the individual items by a colon.
- Any parameter with an argument can be entered as -parameter=argument.
- Entering -param= means the argument is an empty string, equivalent to -param.
- The symbol '--' is valid as the next to last entry on the command line. It specifies that the next entry is the target object name or ID, even if it begins with a hyphen.
chuser -usergrp=-usergrp -- -password
- The symbol '--' is valid as the final word on the command line.

Examples that are valid:

```
mkuser -name fred -usergrp 0 -password buckets
mkuser -name fred -usergrp 0 -password=buckets
mkuser -name fred -usergrp 0 -password=buckets --
mkuser -name=-barney -usergrp=0 -password=buckets
```

```
chuser -usergrp 1 fred
chuser -usergrp 1 -- fred
chuser -usergrp 1 -- -barney
```

Examples that are invalid:

```
chuser -usergrp 1 fred --
chuser -usergrp 1 -- fred --
chuser -- -usergrp 1 fred
chuser -usergrp 1 -barney
```

CLI flags

The following flags are common to all command-line interface (CLI) commands.

-? or -h

Print help text. For example, issuing **lscluster -h** provides a list of the actions available with the **lscluster** command.

-nomsg

When used, this flag prevents the display of the successfully created output. For example, if you issue the following command:

```
mkmdiskgrp -ext 16
```

it displays:

```
MDisk Group, id [6], successfully created
```

However, if the -nomsg parameter is added, for example:

```
mkmdiskgrp -ext 16 -nomsg
```

the following information is displayed:

```
6
```

This parameter can be entered for any command, but is only acted upon by those commands that generate the successfully created outputs. All other commands ignore this parameter.

CLI messages

Ensure that you are familiar with the command-line interface (CLI) messages.

When some commands complete successfully, textual output is normally provided. However, some commands do not provide any output. The phrase No feedback is used to indicate that no output is provided. If the command does not complete successfully, an error is generated. For example, if the command has failed as a result of the cluster being unstable, the following output is provided:

- CMMVC5786E The action failed because the cluster is not in a stable state.

Attributes of the `-filtervalue` parameters

The `-filtervalue` parameter filters a view that is based on specific attribute values that relate to each object type. You can combine multiple filters to create specific searches, for example, `-filtervalue name=fred:status=online`. The help (`-filtervalue?`) specifies the attributes that are available for each object type.

The `-filtervalue` parameter must be specified with `attrib=value`. The `-filtervalue?` and `-filtervalue` parameters cannot be specified together.

Note: The qualifier characters left bracket (<) and right bracket (>) must be enclosed within double quotation marks (""). For example, `-filtervalue vdisk_count "<"4 or port_count ">"1`. It is also valid to include the entire expression within double quotation marks. For example, `-filtervalue "vdisk_count<4"`

When an attribute requires the `-unit` parameter, it is specified after the attribute. For example, `-filtervalue capacity=24 -unit mb`. The following input options are valid for the `-unit` parameter:

- **b** (bytes)
- **mb** (Megabytes)
- **gb** (Gigabytes)
- **tb** (Terabytes)
- **pb** (Petabytes)

Capacity values displayed in units other than bytes might be rounded. When filtering on capacity, use a unit of bytes, `-unit b`, for exact filtering.

Table 5 provides a list of valid filter attributes, as well as descriptions, qualifiers and wildcards for each object type.

You can use the asterisk (*) character as a wildcard character when names are used. The asterisk character can be used either at the beginning or the end of a text string, but not both. Only one asterisk character can be used in a `-filtervalue` parameter.

Table 5. Valid filter attributes

Object	Attribute	Valid Qualifiers	Wildcard Valid	Description
cluster	<code>cluster_name</code> or <code>name</code>	=	Yes	The cluster name.
	<code>cluster_unique_id</code> or <code>id</code>	=, <, <=, >, >=	No	The cluster ID.

Table 5. Valid filter attributes (continued)

Object	Attribute	Valid Qualifiers	Wildcard Valid	Description
node	<i>node_name</i> or <i>name</i>	=	Yes	The node name.
	<i>id</i>	=, <, <=, >, >=	No	The node ID.
	<i>status</i>	=	No	The status of the node. The following values are valid for node <i>status</i> : <ul style="list-style-type: none"> • adding • deleting • online • offline • pending
	<i>IO_group_name</i>	=	Yes	The I/O group name.
	<i>IO_group_id</i>	=, <, <=, >, >=	No	The I/O group ID.
	<i>hardware</i>	=	No	The following values are valid for <i>hardware</i> type: 8F2 , 8F4 , 8G4 , CF8 , and 8A4 .
io_grp	<i>HWS_name</i> or <i>name</i>	=	Yes	The I/O group name.
	<i>HWS_unique_id</i> or <i>id</i>	=, <, <=, >, >=	No	The I/O group ID.
	<i>node_count</i>	=, <, <=, >, >=	No	The number of nodes in the I/O group.
	<i>host_count</i>	=, <, <=, >, >=	No	The number of hosts associated with the io_grp.
controller	<i>controller_id</i> or <i>id</i>	=, <, <=, >, >=	No	The controller ID.

Table 5. Valid filter attributes (continued)

Object	Attribute	Valid Qualifiers	Wildcard Valid	Description
mdisk	<i>name</i>	=	Yes	The name of the MDisk.
	<i>id</i>	=, <, <=, >, >=	No	The ID of the MDisk.
	<i>controller_name</i>	=	Yes	The name of the controller the MDisk belongs to.
	<i>status</i>	=	No	The status of the MDisk. The following values are valid for MDisk <i>status</i> : <ul style="list-style-type: none"> • online • degraded_ports • degraded_paths • offline • excluded
	<i>mode</i>	=	No	The mode of the MDisk. The following values are valid for MDisk <i>mode</i> : <ul style="list-style-type: none"> • unmanaged • managed • image
	<i>mdisk_grp_name</i>	=	Yes	The MDisk group name.
	<i>mdisk_grp_id</i>	=, <, <=, >, >=	No	The MDisk group ID.
	<i>capacity</i>	=, <, <=, >, >=	No	The capacity. Requires the -unit parameter.
mdiskgrp	<i>tier</i>	=	No	The tier information being reported: <ul style="list-style-type: none"> • generic_hdd • generic_ssd
	<i>name</i>	=	Yes	The MDisk group name.
	<i>storage_pool_id</i> or <i>id</i>	=, <, <=, >, >=	No	The MDisk group ID.
	<i>mdisk_count</i>	=, <, <=, >, >=	No	The number of MDisks in the group.
	<i>vdisk_count</i>	=, <, <=, >, >=	No	The number of VDIs in the group.
	<i>status</i>	=	No	The status of the MDisk group. The valid input options are online , degraded_ports , degraded_paths , excluded , and offline .
	<i>extent_size</i>	=, <, <=, >, >=	No	The extent size. (MB)
	<i>easy_tier</i>	=	No	Determines if Easy Tier is permitted to manage the storage pool: <ul style="list-style-type: none"> • on • off
<i>easy_tier_status</i>	=	No	Determines if automatic data placement function on a storage pool is activated: <ul style="list-style-type: none"> • active • inactive 	

Table 5. Valid filter attributes (continued)

Object	Attribute	Valid Qualifiers	Wildcard Valid	Description
vdisk	<i>vdisk_name</i> or <i>name</i>	=	Yes	The name of the VDisk.
	<i>vdisk_id</i> or <i>id</i>	=, <, <=, >, >=	No	The ID of the VDisk.
	<i>IO_group_name</i>	=	Yes	The name of the I/O group.
	<i>IO_group_id</i>	=, <, <=, >, >=	No	The ID of the I/O group.
	<i>status</i>	=	No	The status of the VDisk. The valid input options for VDisk status are online , degraded , and offline .
	<i>mdisk_grp_name</i>	=	Yes	The MDisk group name.
	<i>mdisk_grp_id</i>	=, <, <=, >, >=	No	The MDisk group ID.
	<i>capacity</i>	=, <, <=, >, >=	No	The capacity. Requires the -unit argument.
	<i>type</i>	=	No	The VDisk type. The valid value options are seq , striped , and image .
	<i>FC_name</i>	=	Yes	The FlashCopy mapping name.
	<i>FC_id</i>	=, <, <=, >, >=	No	The FlashCopy mapping ID.
	<i>fc_map_count</i>	=, <, <=, >, >=	No	The number of VDisk mappings (either source or target).
	<i>copy_count</i>	=, <, <=, >, >=	No	The number of VDisk mirrored copies.
<i>RC_name</i>	=	Yes	The Metro Mirror relationship name.	
<i>RC_id</i>	=, <, <=, >, >=	No	The Metro Mirror relationship ID.	

Table 5. Valid filter attributes (continued)

Object	Attribute	Valid Qualifiers	Wildcard Valid	Description
vdisk_copy	<i>primary</i>	=	No	Indicates that this copy is the primary copy. The valid values are yes and no .
	<i>status</i>	=	No	The status of the MDisk group. Valid values are online , degraded , or offline .
	<i>sync</i>	=	No	Indicates whether the VDisk copy is synchronized. Valid values are true or false .
	<i>mdisk_grp_name</i>	=	Yes	The name of the MDisk group.
	<i>mdisk_grp_id</i>	=, <, <=, >, >=	No	The ID of the MDisk group.
	<i>type</i>	=	No	The type of the VDisk copy. The valid values are seq , striped , or image .
	<i>easy_tier</i>	=	No	Determines if Easy Tier is permitted to manage the storage pool: <ul style="list-style-type: none"> • on • off
	<i>easy_tier_status</i>	=	No	Determines if automatic data placement function on a storage pool is activated: <ul style="list-style-type: none"> • active • measured • inactive
se_vdiskcopy	<i>mdisk_grp_id</i>	=, <, <=, >, >=	No	The ID of the MDisk group.
	<i>mdisk_grp_name</i>	=	Yes	The name of the MDisk group.
	<i>overallocation</i>	=	No	The percentage of overallocation, which is displayed as a number.
	<i>autoexpand</i>	=	No	Autoexpand flags. The valid values are on and off .
	<i>grainsize</i>	=, <, <=, >, >=	No	Space-efficient grain size. The valid values are 32 , 64 , 128 , or 256 .
host	<i>host_name</i> or <i>name</i>	=	Yes	The host name.
	<i>host_id</i> or <i>id</i>	=, <, <=, >, >=	No	The host ID.
	<i>port_count</i>	=, <, <=, >, >=	No	The number of ports.
	<i>iogrp_count</i>	=, <, <=, >, >=	No	The number of I/O groups that are associated with the host.

Table 5. Valid filter attributes (continued)

Object	Attribute	Valid Qualifiers	Wildcard Valid	Description
fcmap	<i>FC_mapping_name</i> or <i>name</i>	=	Yes	The FlashCopy mapping name.
	<i>FC_id</i> or <i>id</i>	=, <, <=, >, >=	No	The FlashCopy mapping ID.
	<i>source_vdisk_name</i>	=	Yes	The source VDisk name.
	<i>source_vdisk_id</i>	=, <, <=, >, >=	No	The source VDisk ID.
	<i>target_vdisk_name</i>	=	Yes	The target VDisk name.
	<i>target_vdisk_id</i>	=, <, <=, >, >=	No	The target VDisk ID.
	<i>group_name</i>	=	Yes	The consistency group name.
	<i>group_id</i>	=, <, <=, >, >=	No	The consistency group ID.
	<i>status</i>	=	No	The mapping status. The following values are valid for <i>fcmap status</i> : <ul style="list-style-type: none"> • idle_or_copied • preparing • prepared • copying • stopped • suspended • stopping • empty
	<i>copy_rate</i>	=, <, <=, >, >=	No	The background copy rate.
fcconsistgrp	<i>name</i>	=	Yes	The consistency group name.
	<i>FC_group_id</i> or <i>id</i>	=, <, <=, >, >=	No	The consistency group ID.
	<i>status</i>	=	No	The consistency group status. The following values are valid for <i>fcconsistgrp status</i> : <ul style="list-style-type: none"> • idle_or_copied • preparing • prepared • copying • stopped • suspended • stopping • empty

Table 5. Valid filter attributes (continued)

Object	Attribute	Valid Qualifiers	Wildcard Valid	Description
rcrelationship	<i>RC_rel_id</i> or <i>id</i>	=, <, <=, >, >=	No	The Metro Mirror relationship ID.
	<i>RC_rel_name</i> or <i>name</i>	=	Yes	The Metro Mirror relationship name.
	<i>master_cluster_id</i>	=, <, <=, >, >=	No	The master cluster ID.
	<i>master_cluster_name</i>	=	Yes	The master cluster name.
	<i>master_vdisk_id</i>	=, <, <=, >, >=	No	The master VDisk ID.
	<i>master_vdisk_name</i>	=	Yes	The master VDisk name.
	<i>aux_cluster_id</i>	=, <, <=, >, >=	No	The aux cluster ID.
	<i>aux_cluster_name</i>	=	Yes	The aux cluster name.
	<i>aux_vdisk_id</i>	=, <, <=, >, >=	No	The aux VDisk ID.
	<i>aux_vdisk_name</i>	=	Yes	The aux VDisk name.
	<i>primary</i>	=	No	The relationship primary. The following values are valid for <i>primary</i> : <ul style="list-style-type: none"> • master • aux
	<i>consistency_group_id</i>	=, <, <=, >, >=	No	The Metro Mirror consistency group ID.
	<i>consistency_group_name</i>	=	Yes	The Metro Mirror consistency group name.
	<i>state</i>	=	Yes	The relationship state. The following values are valid for <i>state</i> : <ul style="list-style-type: none"> • inconsistent_stopped • inconsistent_copying • consistent_stopped • consistent_synchronized • idling • idling_disconnected • inconsistent_disconnected • consistent_disconnected
<i>progress</i>	=, <, <=, >, >=	No	The progress of the initial background copy (synchronization) for the relationship.	

Table 5. Valid filter attributes (continued)

Object	Attribute	Valid Qualifiers	Wildcard Valid	Description
rconsistgrp	<i>group_id</i> or <i>id</i>	=, <, <=, >, >=	No	The consistency group ID.
	<i>name</i>	=	Yes	The consistency group name.
	<i>master_cluster_id</i>	=, <, <=, >, >=	No	The master cluster ID.
	<i>master_cluster_name</i>	=	Yes	The master cluster name.
	<i>aux_cluster_id</i>	=, <, <=, >, >=	No	The aux cluster ID.
	<i>aux_cluster_name</i>	=	Yes	The aux cluster name.
	<i>primary</i>	=	No	The consistency group primary. The following values are valid for <i>primary</i> : <ul style="list-style-type: none"> • master • aux
	<i>state</i>	=	No	The consistency group state. The following values are valid for <i>state</i> : <ul style="list-style-type: none"> • inconsistent_stopped • inconsistent_copying • consistent_stopped • consistent_synchronized • idling • idling_disconnected • inconsistent_disconnected • consistent_disconnected • empty
<i>relationship_count</i>	=, <, <=, >, >=	No	The relationship count.	
user	<i>password</i>	=	No	Specifies if a password is associated with the user. The valid values are yes or no .
	<i>ssh_key</i>	=	No	Specifies if a Secure Shell (SSH) public key is associated with the user. The valid values are yes or no .
	<i>remote</i>	=	No	Specifies if the user authenticates to the cluster using a remote authentication service. The valid values are yes or no .
	<i>usergrp_id</i>	=, <, <=, >, >=	No	The ID of the user group.
	<i>usergrp_name</i>	=	Yes	The name of the user group.
usergrp	<i>role</i>	=	No	The role associated with all users that belong to this user group. The valid values are Monitor , CopyOperator , Service , Administrator , or SecurityAdmin .
	<i>remote</i>	=	No	Specifies if the user group is used to set the role of remote users. The valid values are yes or no .

Table 5. Valid filter attributes (continued)

Object	Attribute	Valid Qualifiers	Wildcard Valid	Description
clusterip	<i>port_id</i>	=, <, <=, >, >=	No	The port ID. The valid values are 1 or 2 .
	<i>cluster_name</i>	=	Yes	The cluster name.
	<i>cluster_id</i>	=, <, <=, >, >=	No	The cluster ID.

Chapter 1. Preparing the SSH client

Secure Shell (SSH) is a client-server network application. It is a communication vehicle between the host system and the SAN Volume Controller command-line interface (CLI).

Overview

The SAN Volume Controller clustered system acts as the SSH server in this relationship. The SSH client provides a secure environment in which to connect to a remote machine. It uses the principles of public and private keys for authentication.

SSH keys are generated by the SSH software. This includes a public key, which is uploaded and maintained by the clustered system, and a private key that is kept private to the host that is running the SSH client. These keys authorize specific users to access the administration and service functions on the clustered system. Each key is associated with a user on the clustered system. Up to 400 users can be defined on the clustered system. You can also create new users and assign keys to them.

Authenticating SSH logins

When you are using AIX® hosts, SSH logins are authenticated on the clustered system using the RSA-based authentication that is supported in the OpenSSH client that is available for AIX. This scheme is based on public-key cryptography, using an algorithm known commonly as RSA.

Note: The authentication process for non-AIX hosts systems is similar.

With this scheme (as in similar OpenSSH systems on other host types), the encryption and decryption is done using separate keys. This means that it is not possible to derive the decryption key from the encryption key.

Because physical possession of the private key allows access to the cluster, the private key must be kept in a protected place, such as the .ssh directory on the AIX host, with restricted access permissions.

When SSH client (A) attempts to connect to SSH server (B), the key pair authenticates the connection. The key consists of two halves: the public keys and private keys. The SSH client public key is put onto SSH Server (B) using some means outside of the SSH session. When SSH client (A) tries to connect, the private key on SSH client (A) is able to authenticate with its public half on SSH server (B).

- | You can connect to the clustered system using the same user name with which you log into SAN Volume Controller.
- | **Storwize V7000:** You can connect to the clustered system using the same user name with which you log into Storwize V7000.

Preparing the SSH client on a Windows host

If you use the Secure Shell (SSH) to log in to the SAN Volume Controller or Storwize V7000, you must use the RSA-based private key authentication. This topic describes how to prepare the SSH client on a Windows host.

The IBM System Storage Productivity Center (SSPC) and the workstation for the SAN Volume Controller include the PuTTY client program, which is a Microsoft Windows SSH client program. The PuTTY client program can be installed on your SSPC or workstation server in one of these ways:

- If you purchased the SSPC or the workstation hardware option from IBM, the PuTTY client program has been preinstalled on the hardware.
- You can use the workstation software installation CD to install the PuTTY client program. The SSPC, workstation hardware option, and the software-only workstation each provide this CD.
- You can use the separate PuTTY client program-installation wizard, **putty-version-installer.exe**. You can download the PuTTY client program from this website:
www.chiark.greenend.org.uk/~sgtatham/putty/

Note: Before you install the PuTTY client program, ensure that your Windows system meets the system requirements. See the *IBM System Storage Productivity Center Introduction and Planning Guide* for system requirements.

If you want to use an SSH client other than the PuTTY client, this website offers SSH client alternatives for Windows:

www.openssh.org/windows.html

- | You can connect to the clustered system using the same user name with which you log into SAN Volume Controller.
- | **Storwize V7000:** You can connect to the clustered system using the same user name with which you log into Storwize V7000.

Generating an SSH key pair using PuTTY

You must generate a Secure Shell (SSH) key pair to use the SAN Volume Controller command-line interface (CLI).

Perform the following steps to generate SSH keys using the PuTTY key generator (PuTTYgen):

1. Start PuTTYgen by clicking **Start > Programs > PuTTY > PuTTYgen**. The PuTTY Key Generator panel is displayed.
2. Click **SSH-2 RSA** as the type of key to generate.

Note: Leave the number of bits in a generated key value at 1024.

3. Click **Generate** and then move the cursor around the blank area of the Key section to generate the random characters that create a unique key. When the key has been completely generated, the information about the new key is displayed in the Key section.

Attention: Do not modify the Key fingerprint or the Key comment fields; this can cause your key to no longer be valid.

4. (Optional) Enter a passphrase in the **Key passphrase** and **Confirm passphrase** fields. The passphrase encrypts the key on the disk; therefore, it is not possible to use the key without first entering the passphrase.
5. Save the public key by performing the following steps:
 - a. Click **Save public key**. You are prompted for the name and location of the public key.
 - b. Type `icat.pub` as the name of the public key and specify the location where you want to save the public key. For example, you can create a directory on your computer called *keys* to store both the public and private keys.
 - c. Click **Save**.
6. Save the private key by performing the following steps:
 - a. Click **Save private key**. The PuTTYgen Warning panel is displayed.
 - b. Click **Yes** to save the private key without a passphrase.

- c. Type `icat` as the name of the private key, and specify the location where you want to save the private key. For example, you can create a directory on your computer called *keys* to store both the public and private keys. It is recommended that you save your public and private keys in the same location.
 - d. Click **Save**.
7. Close the PuTTY Key Generator window.

Configuring a PuTTY session for the CLI

You must configure a PuTTY session using the Secure Shell (SSH) key pair that you have generated before you can use the command-line interface (CLI).

Attention: Do not run scripts that create child processes that run in the background and call SAN Volume Controller commands. This can cause the system to lose access to data and cause data to be lost.

Perform the following steps to configure a PuTTY session for the CLI:

1. Select **Start > Programs > PuTTY > PuTTY**. The PuTTY Configuration window opens.
2. Click **Session** in the Category navigation tree. The Basic options for your PuTTY session are displayed.
3. Click **SSH** as the Protocol option.
4. Click **Only on clean exit** as the Close window on exit option. This ensures that connection errors are displayed.
5. Click **Connection > SSH** in the Category navigation tree. The options controlling SSH connections are displayed.
6. Click **2** as the Preferred SSH protocol version.
7. Click **Connection > SSH > Auth** in the Category navigation tree. The Options controller SSH authentication are displayed.
8. Click **Browse** or type the fully qualified file name and location of the SSH client and private key in the **Private key file for authentication** field.
9. Click **Connection > Data** in the Category navigation tree.
10. Type the user name that you want to use on the SAN Volume Controller in the **Auto-login username** field.
11. Click **Session** in the Category navigation tree. The Basic options for your PuTTY session are displayed.
12. In the **Host Name (or IP Address)** field, type the name or IP address of one of the SAN Volume Controller cluster IP addresses or host names.
13. Type **22** in the **Port** field. The SAN Volume Controller cluster uses the standard SSH port.
14. Type the name that you want to use to associate with this session in the **Saved Sessions** field. For example, you can name the session SAN Volume Controller Cluster 1.
15. Click **Save**.

You have now configured a PuTTY session for the CLI.

Note: If you configured more than one IP address for the SAN Volume Controller cluster, repeat the previous steps to create another saved session for the second IP address. This can then be used if the first IP address is unavailable.

Connecting to the CLI using PuTTY

Ensure that you are familiar with how to run the PuTTY and plink utilities.

Note: Windows users can download PuTTY from the following website: <http://www.chiark.greenend.org.uk/~sgtatham/putty/download.html>(<http://www.chiark.greenend.org.uk/~sgtatham/putty/download.html>).

The Secure Shell (SSH) protocol specifies that the first access to a new host server sends a challenge to the SSH user to accept the SSH server public key. Because this is the first time that you connect to an SSH server, the server is not included in the SSH client list of known hosts. Therefore, there is a fingerprint challenge, which asks if you accept the responsibility of connecting with this host. If you type *y*, the host fingerprint and IP address are saved by the SSH client.

When you use PuTTY, you must also type *y* to accept this host fingerprint. However, the host fingerprint and IP address are stored in the registry for the user name that is logged onto Windows.

The SSH protocol also specifies that once the SSH server public key is accepted, another challenge is presented if the fingerprint of an SSH server changes from the one previously accepted. In this case, you must decide if you want to accept this changed host fingerprint.

Note: The SSH server keys on the SAN Volume Controller are regenerated when a microcode load is performed on the clustered system. As a result, a challenge is sent because the fingerprint of the SSH server has changed.

All command-line interface (CLI) commands are run in an SSH session. You can run the commands in one of the following modes:

- An interactive prompt mode
- A single line command mode, which is entered one time to include all parameters

Interactive mode

For interactive mode, you can use the PuTTY executable to open the SSH restricted shell.

The following is an example of the command that you can issue to start interactive mode:

```
| C:\support\utils\putty <username>@svccconsoleip
```

where *support\utils\putty* is the location of your *putty.exe* file, *svccconsoleip* is the IP address of your management GUI, and *<username>* is the user name that you want to use on SAN Volume Controller.

| If you were to issue the **lsuser** command, which lists the SSH client public keys that are stored on the SAN Volume Controller clustered system, the following output is displayed when *ssh_key=true*:

```
| IBM_2145:cluster0:superuser>lsuser
| id name      password ssh_key remote usergrp_id usergrp_name
| 0 superuser  yes      yes    no     0      SecurityAdmin
| 1 smith      no       yes    no     4      Monitor
| 2 jones      no       yes    no     2      CopyOperator
```

You can type *exit* and press **Enter** to escape the interactive mode command.

The following is an example of the host fingerprint challenge when using *plink* in interactive mode:

```

C:\Program Files\IBM\svconconsole\cimom>plink superuser@9.43.225.208
The server's host key is not cached in the registry. You
have no guarantee that the server is the computer you
think it is.
The server's key fingerprint is:
ssh-rsa 1024 e4:c9:51:50:61:63:e9:cd:73:2a:60:6b:f0:be:25:bf
If you trust this host, enter "y" to add the key to
PuTTY's cache and carry on connecting.
If you want to carry on connecting just once, without
adding the key to the cache, enter "n".
If you do not trust this host, press Return to abandon the
connection.
Store key in cache? (y/n) y
Using user name "superuser".
Authenticating with public key "imported-openssh-key"
IBM_2145:your_cluster_name:superuser>

```

Single line command

For single line command mode, you can type the following all on one command line:

```

C:\Program Files\IBM\svconconsole\cimom>
plink superuser@9.43.225.208 lsuser
Authenticating with public key "imported-openssh-key"
id name      password ssh_key remote usergrp_id usergrp_name
0  superuser  yes      yes      no      0      SecurityAdmin
1  smith      no       yes      no      4      Monitor
2  jones      no       yes      no      2      CopyOperator

```

Note: If you are submitting a CLI command with all parameters in single line command mode, you are challenged upon first appearance of the SSH server host fingerprint. Ensure that the SSH server host fingerprint is accepted before you submit a batch script file.

The following is an example of the host fingerprint challenge when using plink in single line command mode:

```

C:\Program Files\IBM\svconconsole\cimom>
plink superuser@9.43.225.208 lsuser
The server's host key is not cached in the registry. You
have no guarantee that the server is the computer you
think it is.
The server's key fingerprint is:
ssh-rsa 1024 e4:c9:51:50:61:63:e9:cd:73:2a:60:6b:f0:be:25:bf
If you trust this host, enter "y" to add the key to
PuTTY's cache and carry on connecting.
If you want to carry on connecting just once, without
adding the key to the cache, enter "n".
If you do not trust this host, press Return to abandon the
connection.
Store key in cache? (y/n) y
Authenticating with public key "imported-openssh-key"
id name      password ssh_key remote usergrp_id usergrp_name
0  superuser  yes      yes      no      0      SecurityAdmin
1  smith      no       yes      no      4      Monitor
2  jones      no       yes      no      2      CopyOperator

```

Starting a PuTTY session for the CLI

You must start a PuTTY session to connect to the command-line interface (CLI).

This task assumes that you have already configured and saved a PuTTY session using the Secure Shell (SSH) key pair that you created for the CLI.

Perform the following steps to start a PuTTY session:

1. Select **Start > Programs > PuTTY > PuTTY**. The PuTTY Configuration window opens.
2. Select the name of your saved PuTTY session and click **Load**.
3. Click **Open**.

Note: If this is the first time that the PuTTY application is being used since you generated and uploaded the SSH key pair, a PuTTY Security Alert window is displayed. Click **Yes** to accept the change and trust the new key.

4. Type the `SVC_username` in the **login as:** field and press **Enter**.

Preparing the SSH client on an AIX or Linux host

If you use the Secure Shell (SSH) to log in to the SAN Volume Controller or Storwize V7000, you must use the RSA-based private key authentication, instead of a typical user name and password. This topic describes how to prepare the SSH client on an AIX or Linux host.

Ensure that you have an SSH client installed on your system:

IBM AIX operating systems

For IBM AIX 5L™ for POWER®, versions 5.1, 5.2, 5.3, and AIX version 6.1 for IBM POWER6® architecture, you can obtain the OpenSSH client from the bonus packs, but you also must obtain its prerequisite, OpenSSL, from the IBM AIX toolbox for Linux applications for IBM Power Systems™. For AIX 4.3.3, you can obtain the software from the AIX toolbox for Linux applications. You can also obtain the AIX installation images from IBM developerWorks® at the following website:

oss.software.ibm.com/developerworks/projects/openssh

Linux operating systems

The OpenSSH client is installed by default on most Linux distributions. If it is not installed on your system, consult your Linux installation documentation or visit the following website:

www.openssh.org/portable.html

The OpenSSH client can run on a variety of additional operating systems. For more information about the openSSH client, visit the following website:

www.openssh.org/portable.html

Perform the following steps to set up an RSA key pair on the AIX or Linux host and the SAN Volume Controller or Storwize V7000 cluster:

1. Create an RSA key pair by issuing a command on the host that is similar to the following command:
`ssh-keygen -t rsa`

Tip: Issue the command from the `$HOME/.ssh` directory.

This process generates two user named files. If you select the name *key*, the files are named *key* and *key.pub*. Where *key* is the name of the private key and *key.pub* is the name of the public key.

2. Associate the public key with a user on the SAN Volume Controller or Storwize V7000 system. using the management GUI.

You can now access the cluster with an SSH command similar to the following:

```
| ssh -i full_path_to_key username@my_cluster
```

- | Where *my_cluster* is the name of the cluster IP, *username* is the user name that you also log into the
- | system with, and *full_path_to_key* is the full path to the *key* file that was generated in the previous step.
- | The SAN Volume Controller software determines which user is logging in from the key they are using.

Note: You can omit `-i full_path_to_key` if you configure the SSH client to use the key file automatically. For more information, refer to the OpenSSH documentation.

Generating an SSH key pair using OpenSSH

This topic describes how to generate an SSH key pair using OpenSSH.

Perform these steps to set up an RSA key pair on the AIX or Linux host and the SAN Volume Controller or Storwize V7000 clustered system:

1. Create an RSA key pair by issuing a command on the host that is similar to this command:

```
ssh-keygen -t rsa
```

Tip: Issue the command from the `$HOME/.ssh` directory.

This process generates two user named files. If you select the name *key*, the files are named *key* and *key.pub*. Where *key* is the name of the private key and *key.pub* is the name of the public key.

2. Associate the public key with a user on the SAN Volume Controller or Storwize V7000 system. using the management GUI.

Connecting to the CLI using OpenSSH

This topic describes how to connect to the CLI using OpenSSH.

You can access the clustered system with an SSH command similar to the following:

- | `ssh -i full_path_to_key <SVCusername>@my_cluster`

- | Where *my_cluster* is the name of the system IP, *full_path_to_key* is the full path to the *key* file that was
- | generated in the previous step, and *<SVCusername>* is the user name that you want to use on SAN
- | Volume Controller.

Note: You can omit `-i full_path_to_key` if you configure the SSH client to use the key file automatically. For more information, refer to the OpenSSH documentation.

Creating users

You can create either a local or a remote user to access a SAN Volume Controller clustered system (system).

You can create two categories of users that access the system. These types are based on how the users are authenticated to the system. Local users must provide either a password, a Secure Shell (SSH) key, or both. Local users are authenticated through the authentication methods that are located on the SAN Volume Controller system. If the local user needs access to management GUI, a password is needed for the user. If the user requires access to the command-line interface (CLI) then a valid SSH key file is necessary. If a user is working with both interfaces, then both a password and SSH key are required. Local users must be part of a user group that is defined on the system. User groups define roles that authorize the users within that group to a specific set of operations on the system.

A remote user is authenticated on a remote service usually provided by a SAN management application, such as IBM Tivoli® Storage Productivity Center, and does not need local authentication methods. For a remote user, both a password and SSH key are required to use the command-line interface. Remote users only need local credentials to access to the management GUI if the remote service is down. Remote users have their groups defined by the remote authentication service.

| You can connect to the clustered system using the same user name with which you log into SAN Volume
| Controller.

| **Storwize V7000:** You can connect to the clustered system using the same user name with which you log
| into Storwize V7000.

Complete these steps to create either a local or remote user:

1. Select **User Management > Users** .
2. Click **New User** .
- | 3. Enter the information on the new user and click **Create**.

Chapter 2. Copying the SAN Volume Controller software upgrade files using PuTTY scp

PuTTY scp (pscp) provides a file transfer application for secure shell (SSH) to copy files either between two directories on the configuration node or between the configuration node and another host.

To use the pscp application, you must have the appropriate permissions on the source and destination directories on your respective hosts.

The pscp application is available when you install an SSH client on your host system. You can access the pscp application through a Microsoft Windows command prompt.

Perform these steps to use the pscp application:

1. Start a PuTTY session.
2. Configure your PuTTY session to access your SAN Volume Controller clustered system (system).
3. Save your PuTTY configuration session. For example, you can name your saved session SVCPUTTY.
4. Open a command prompt.
5. Issue this command to set the path environment variable to include the PuTTY directory:

```
set path=C:\Program Files\putty;%path%
```

where *Program Files* is the directory where PuTTY is installed.

6. Issue this command to copy the package onto the node where the CLI runs:

```
| pscp -load saved_putty_configuration  
| directory_software_upgrade_files/software_upgrade_file_name  
| username@cluster_ip_address:/home/admin/upgrade
```

```
| where saved_putty_configuration is the name of the PuTTY configuration session,  
| directory_software_upgrade_files is the location of the software upgrade files, software_upgrade_file_name is the  
| name of the software upgrade file, username is the name that you want to use on the SAN Volume  
| Controller, and cluster_ip_address is an IP address of your clustered system.
```

```
| If there is insufficient space to store the software upgrade file on the system, the copy process fails.  
| Perform these steps:
```

- ```
| a. Use pscp to copy data that you want to preserve from the /dumps directory. For example, issue
| this command to copy all event logs from the system to the IBM System Storage Productivity
| Center:
```

```
| pscp -unsafe -load saved_putty_configuration
| username@cluster_ip_address:/dumps/elogs/*
| your_preferred_directory
```

```
| where saved_putty_configuration is the name of the PuTTY configuration session, username is the
| name that you want to use on the SAN Volume Controller, cluster_ip_address is the IP address of
| your system, and your_preferred_directory is the directory where you want to transfer the event
| logs.
```

- ```
| b. Issue the cleardumps command to free space on the system:
```

```
cleardumps -prefix /dumps
```

- ```
| c. Then repeat step 6.
```



---

## Chapter 3. Using the CLI

The SAN Volume Controller clustered system command-line interface (CLI) is a collection of commands that you can use to manage the SAN Volume Controller.

### Overview

The CLI commands use the Secure Shell (SSH) connection between the SSH client software on the host system and the SSH server on the SAN Volume Controller clustered system.

Before you can use the CLI, you must have already created a clustered system.

You must perform these actions to use the CLI from a client system:

- Install and set up SSH client software on each system that you plan to use to access the CLI.
- Generate an SSH key pair on each SSH client.
- Store the SSH public key for each SSH client on the SAN Volume Controller.

**Note:** After the first SSH public key is stored, you can add additional SSH public keys using either the management GUI or the CLI.

You can use the CLI to perform these functions:

- Setup of the clustered system, its nodes, and the I/O groups
- Analyze error logs (event logs)
- Setup and maintenance of managed disks (MDisk) and storage pools
- Setup and maintenance of client public SSH keys on the clustered system
- Setup and maintenance of volumes
- Setup of logical host objects
- Map volumes to hosts
- Navigate from managed hosts to volumes and to MDisks, and the reverse direction up the chain
- Set up and start Copy Services:
  - FlashCopy and FlashCopy consistency groups
  - Synchronous Metro Mirror and Metro Mirror consistency groups
  - Asynchronous Global Mirror and Global Mirror consistency groups

---

### Setting the clustered system time using the CLI

You can use the command-line interface (CLI) to set the clustered system time.

Perform the following steps to set the clustered system time:

1. Issue the **showtimezone** CLI command to display the current time-zone settings for the clustered system. The time zone and the associated time-zone ID are displayed.
2. Issue the **lstimezones** CLI command to list the time zones that are available on the clustered system. A list of valid time-zone settings are displayed. Each time zone is assigned an ID. The time zone and the associated ID are indicated in the list.
3. Issue the following CLI command to set the time zone for the clustered system.

```
settimezone -timezone time_zone_setting
```

where *time\_zone\_setting* is the new time zone ID that you have chosen from the list of time zones that are available on the clustered system.

4. Issue the following CLI command to set the time for the clustered system:

```
setclustertime -time 031809142005
```

where *031809142005* is the new time that you want to set for the clustered system. You must use the *MMDDHHmmYYYY* format to set the time for the clustered system.

---

## Viewing and updating license settings using the CLI

You can use the command-line interface (CLI) to view and update your license settings.

SAN Volume Controller provides two license options: Physical Disk Licensing and Capacity Licensing. Perform the following steps to view and update your SAN Volume Controller license settings:

1. Issue the **lslicense** CLI command to view the current license settings for the clustered system.
2. Issue the **chlicense** CLI command to change the licensed settings of the clustered system.

### Attention:

- License settings are entered when the clustered system is first created; do not update the settings unless you have changed your license.
- To select Physical Disk Licensing, run the **chlicense** command with one or more of the **physical\_disks**, **physical\_flash**, and **physical\_remote** parameters.
- To select Capacity Licensing, run the **chlicense** command with one or more of the **-flash**, **-remote**, and **-virtualization** parameters. If the physical disks value is nonzero, these parameters cannot be set.

---

## Displaying clustered system properties using the CLI

You can use the command-line interface (CLI) to display the properties for a clustered system.

Perform the following step to display clustered system properties:

Issue the **lscluster** command to display the properties for a clustered system.

The following is an example of the command you can issue:

```
lscluster -delim : build1
```

where *build1* is the name of the clustered system.

```
id:000002007A00A0FE
name:build1
location:local
partnership:
bandwidth:
total_mdisk_capacity:90.7GB
space_in_mdisk_grps:90.7GB
space_allocated_to_vdisks:14.99GB
total_free_space:75.7GB
statistics_status:on
statistics_frequency:15
required_memory:0
cluster_locale:en_US
time_zone:522 UTC
code_level:6.1.0.0 (build 47.3.1009031000)
FC_port_speed:2Gb
console_IP:9.71.46.186:443
id_alias:000002007A00A0FE
gm_link_tolerance:300
gm_inter_cluster_delay_simulation:0
gm_intra_cluster_delay_simulation:0
email_reply:
email_contact:
email_contact_primary:
email_contact_alternate:
email_contact_location:
email_state:stopped
inventory_mail_interval:0
total_vdiskcopy_capacity:15.71GB
total_used_capacity:13.78GB
total_overallocation:17
total_vdisk_capacity:11.72GB
cluster_ntp_IP_address:
cluster_isns_IP_address:
iscsi_auth_method:none
iscsi_chap_secret:
auth_service_configured:no
auth_service_enabled:no
auth_service_url:
auth_service_user_name:
auth_service_pwd_set:no
auth_service_cert_set:no
relationship_bandwidth_limit:25
gm_max_host_delay:5
tier:generic_ssd
tier_capacity:0.00MB
tier_free_capacity:0.00MB
tier:generic_hdd
tier_capacity:90.67GB
tier_free_capacity:75.34GB
email_contact2:
email_contact2_primary:
email_contact2_alternate:
total_allocated_extent_capacity:16.12GB
```

---

## Maintaining passwords for the front panel using the CLI

You can use the command-line interface (CLI) to view and change the status of the password reset feature for the SAN Volume Controller front panel.

The clustered system (system) superuser password can be reset using the front panel of the configuration node. To meet varying security requirements, this functionality can be enabled or disabled using the CLI.

Complete the following steps to view and change the status of the password reset feature:

1. Issue the **setpwdreset** CLI command to view and change the status of the password reset feature for the SAN Volume Controller front panel.
2. Record the system superuser password because you cannot access the system without it.

**Storwize® V7000:** The system superuser password can be reset using a USB key. To meet varying security requirements, this functionality can be enabled or disabled using the CLI. Complete the following steps to view and change the status of the password reset feature:

1. Issue the **setpwdreset** CLI command to view and change the status of the password reset feature for the Storwize® V7000.
2. Record the system superuser password because you cannot access the system without it.

---

## Re-adding a repaired node to a clustered system using the CLI

You can use the command-line interface (CLI) to re-add a failed node back into a clustered system after it was repaired.

Before you add a node to a clustered system, you must make sure that the switchd\ zoning is configured such that the node being added is in the same zone as all other nodes in the clustered system. If you are replacing a node and the switch is zoned by worldwide port name (WWPN) rather than by switch port, make sure that the switch is configured such that the node being added is in the same VSAN/zone.

### Attention:

1. If you are re-adding a node to the SAN, ensure that you are adding the node to the same I/O group from which it was removed. Failure to do this can result in data corruption. You must use the information that was recorded when the node was originally added to the clustered system. If you do not have access to this information, call the IBM Support Center to add the node back into the clustered system without corrupting the data.
2. The LUNs that are presented to the ports on the new node must be the same as the LUNs that are presented to the nodes that currently exist in the clustered system. You must ensure that the LUNs are the same before you add the new node to the clustered system.
3. LUN masking for each LUN must be identical on all nodes in a clustered system. You must ensure that the LUN masking for each LUN is identical before you add the new node to the clustered system.
4. You must ensure that the model type of the new node is supported by the SAN Volume Controller software level that is currently installed on the clustered system. If the model type is not supported by the SAN Volume Controller software level, upgrade the clustered system to a software level that supports the model type of the new node. See the following website for the latest supported software levels:

Support for SAN Volume Controller (2145) website at [www.ibm.com/storage/support/2145](http://www.ibm.com/storage/support/2145)

### Special procedures when adding a node to a clustered system

Applications on the host systems direct I/O operations to file systems or logical volumes that are mapped by the operating system to virtual paths (vpaths), which are pseudo disk objects supported by the Subsystem Device Driver (SDD). SDD maintains an association between a vpath and a SAN Volume Controller volume. This association uses an identifier (UID) which is unique to the volume and is never reused. The UID permits SDD to directly associate vpaths with volumes.

SDD operates within a protocol stack that contains disk and Fibre Channel device drivers that are used to communicate with the SAN Volume Controller using the SCSI protocol over Fibre Channel as defined by the ANSI FCS standard. The addressing scheme provided by these SCSI and Fibre Channel device drivers uses a combination of a SCSI logical unit number (LUN) and the worldwide node name (WWNN) for the Fibre Channel node and ports.

If an error occurs, the error recovery procedures (ERPs) operate at various tiers in the protocol stack. Some of these ERPs cause I/O to be redriven using the same WWNN and LUN numbers that were previously used.

SDD does not check the association of the volume with the vpath on every I/O operation that it performs.

Before you add a node to the clustered system, you must check to see if any of the following conditions are true:

- The clustered system has more than one I/O group.
- The node being added to the clustered system uses physical node hardware or a slot which has previously been used for a node in the clustered system.
- The node being added to the clustered system uses physical node hardware or a slot which has previously been used for a node in another clustered system and both clustered systems have visibility to the same hosts and back-end storage.

If any of the previous conditions are true, the following special procedures apply:

- The node must be added to the same I/O group that it was previously in. You can use the command-line interface (CLI) command **lsnode** or the management GUI to determine the WWN of the clustered system nodes.
- Before you add the node back into the clustered system, you must shut down all of the hosts using the clustered system. The node must then be added before the hosts are rebooted. If the I/O group information is unavailable or it is inconvenient to shut down and reboot all of the hosts using the clustered system, then do the following:
  - On all of the hosts connected to the clustered system, unconfigure the Fibre Channel adapter device driver, the disk device driver, and multipathing driver before you add the node to the clustered system.
  - Add the node to the clustered system, and then reconfigure the Fibre Channel adapter device driver, the disk device driver, and multipathing driver.

### Scenarios where the special procedures can apply

The following two scenarios describe situations where the special procedures can apply:

- Four nodes of an eight-node clustered system have been lost because of the failure of a pair of 2145 UPS or four 2145 UPS-1U. In this case, the four nodes must be added back into the clustered system using the CLI command **addnode** or the management GUI.

| **Note:** You do not need to run the **addnode** command on a node with a partner that is already in a clustered system; the clustered system automatically detects an online candidate.

| **Note:** The **addnode** command is a SAN Volume Controller command. For Storwize V7000, use the **addcontrolenclosure** command.

- A user decides to delete four nodes from the clustered system and add them back into the clustered system using the CLI command **addnode** or the management GUI.

| **Note:** The **addnode** command is a SAN Volume Controller command. For Storwize V7000, use the **addcontrolenclosure** command.

For 5.1.0 nodes, the SAN Volume Controller automatically re-adds nodes that have failed back to the clustered system. If the clustered system reports an error for a node missing (error code 1195) and that node has been repaired and restarted, the clustered system automatically re-adds the node back into the clustered system. This process can take up to 20 minutes, so you can manually re-add the node by completing the following steps:

1. Issue the **lsnode** CLI command to list the nodes that are currently part of the clustered system and determine the I/O group for which to add the node.

The following is an example of the output that is displayed:

```
lsnode -delim :

id:name:UPS_serial_number:WWNN:status:I0_group_id:I0_group_name
:config_node:UPS_unique_id:hardware:iscsi_name:iscsi_alias
:panel_name:enclosure_id:canister_id:enclosure_serial_number
1:node1::50050868010050B2:online:0:io_grp0:yes::100:iqn.1986-03.com.ibm
:2145.cluster0.node1::02-1:2:1:123ABCG
2:node2::50050869010050B2:online:0:io_grp0:no::100:iqn.1986-03.com.ibm
:2145.cluster0.node2::02-2:2:2:123ABDG
```

### Storwize V7000 example:

```
lsnode -delim :

id:name:UPS_serial_number:WWNN:status:I0_group_id:I0_group_name
:config_node:UPS_unique_id:hardware:iscsi_name:iscsi_alias
:panel_name:enclosure_id:canister_id:enclosure_serial_number
1:node1::50050868010050B2:online:0:io_grp0:yes::100:iqn.1986-03.com.ibm
:2145.cluster0.node1::02-1:2:1:123ABCG
2:node2::50050869010050B2:online:0:io_grp0:no::100:iqn.1986-03.com.ibm
:2145.cluster0.node2::02-2:2:2:123ABDG
```

- Issue the **lsnodecandidate** CLI command to list nodes that are not assigned to a clustered system and to verify that a second node is added to an I/O group.

**Note:** The **lsnodecandidate** command is a SAN Volume Controller command. For Storwize V7000, use the **lscontrolenclosurecandidate** command.

The following is an example of the output that is displayed:

```
lsnodecandidate -delim :

id:panel_name:UPS_serial_number:UPS_unique_id:hardware
5005076801000001:000341:10L3ASH:202378101C0D18D8:8A4
5005076801000009:000237:10L3ANF:202378101C0D1796:8A4
50050768010000F4:001245:10L3ANF:202378101C0D1796:8A4
....
```

- Issue the **addnode** CLI command to add a node to the clustered system.

**Note:** The **addnode** command is a SAN Volume Controller command. For Storwize V7000, use the **addcontrolenclosure** command.

**Important:** Each node in an I/O group must be attached to a different uninterruptible power supply. The following is an example of the CLI command you can issue to add a node to the clustered system using the panel name parameter:

```
addnode -panelname 000237
-iogrp io_grp0
```

Where *000237* is the panel name of the node, *io\_grp0* is the name of the I/O group that you are adding the node to.

The following is an example of the CLI command you can issue to add a node to the clustered system using the WWNN parameter:

```
addnode -wwnodename 5005076801000001
-iogrp io_grp1
```

Where *5005076801000001* is the WWNN of the node, *io\_grp1* is the name of the I/O group that you are adding the node to.

- Issue the **lsnode** CLI command to verify the final configuration.

The following example shows output that is displayed:



```
lsnode -delim :
id:name:UPS_serial_number:WWNN:status:IO_group_id:IO_group_name:config_node:UPS_unique_id:
hardware:iscsi_name:iscsi_alias
1:node1:10L3ASH:0000000000000000:offline:0:io_grp0:no:1000000000003206:
8A4:iqn.1986-03.com.ibm:2145.ndih111.node1:
```

Record the following information for the new node:

- Node name
- Node serial number
- WWNN
- IQNs (if using hosts attached using iSCSI connections)
- All WWPNS
- I/O group that contains the node

**Note:** If this command is issued quickly after you have added nodes to the clustered system, the status of the nodes might be adding. The status is shown as adding if the process of adding the nodes to the clustered system is still in progress. You do not have to wait for the status of all the nodes to be online before you continue with the configuration process.

The nodes have been added to the clustered system.

---

## Displaying node properties using the CLI

You can use the command-line interface (CLI) to display node properties.

Perform the following steps to display the node properties:

1. Issue the **lsnode** CLI command to display a concise list of nodes in the system.

The following is an example of the CLI command you can issue to list the nodes in the system:

```
lsnode -delim :
```

The following is an example of the output that is displayed:

```
id:name:UPS_serial_number:WWNN:status:IO_group_id:IO_group_name:config_node:UPS_unique_id:hardware:iscsi_name:iscsi_alias:
panel_name:enclosure_id:canister_id:enclosure_serial_number
1:node1:UPS_Fake_SN:50050768010050B1:online:0:io_grp0:yes:10000000000050B1:8G4:iqn.1986-03.com.ibm:2145.cluster0.node1:000368:::
```

2. Issue the **lsnode** CLI command and specify the node ID or name of the node that you want to receive detailed output.

The following is an example of the CLI command you can issue to list detailed output for a node in the system:

```
lsnode -delim : group1node1
```

Where *group1node1* is the name of the node for which you want to view detailed output.

The following is an example of the output that is displayed:

```
id:1
name:group1node1
UPS_serial_number:10L3ASH
WWNN:500507680100002C
status:online
IO_group_id:0
IO_group_name:io_grp0
partner_node_id:2
partner_node_name:group1node2
config_node:yes
UPS_unique_id:202378101C0D18D8
port_id:500507680110002C
port_status:active
port_speed:2GB
port_id:500507680120002C
port_status:active
port_speed:2GB
port_id:500507680130002C
port_status:active
port_speed:2GB
port_id:500507680140003C
port_status:active
port_speed:2GB
hardware:8A4
iscsi_name:iqn.1986-03.com.ibm:2145.ndihill.node2
iscsi_alias
failover_active:no
failover_name:node1
failover_iscsi_name:iqn.1986-03.com.ibm:2145.ndihill.node1
failover_iscsi_alias
```

---

## Discovering MDisks using the CLI

You can use the command-line interface (CLI) to discover managed disks (MDisks).

When back-end controllers are added to the Fibre Channel SAN and are included in the same switch zone as a SAN Volume Controller clustered system (system), the system automatically discovers the back-end controller and integrates the controller to determine the storage that is presented to the SAN Volume Controller nodes. The SCSI logical units (LUs) that are presented by the back-end controller are displayed as unmanaged MDisks. However, if the configuration of the back-end controller is modified after this has occurred, the SAN Volume Controller system might be unaware of these configuration changes. You can request that the SAN Volume Controller system rescans the Fibre Channel SAN to update the list of unmanaged MDisks.

**Note:** The automatic discovery that is performed by SAN Volume Controller system does not write anything to an unmanaged MDisk. You must instruct the SAN Volume Controller system to add an MDisk to a storage pool or use an MDisk to create an image mode volume.

Perform these steps to discover and then view a list of MDisks:

1. Issue the **detectmdisk** CLI command to manually scan the Fibre Channel network. The scan discovers any new MDisks that might have been added to the system and rebalances MDisk access across the available controller device ports.

### Notes:

- a. Only issue the **detectmdisk** command when you are sure that all of the disk controller ports are working and correctly configured in the controller and the SAN zoning. Failure to do this can result in errors that are not reported.
- b. Although it might appear that the **detectmdisk** command has completed, extra time might be required for it to run. The **detectmdisk** is asynchronous and returns a prompt while the command continues to run in the background. You can use the **lsdiscoverystatus** command to view the discovery status.



and have similar performance characteristics. If you do not use Easy Tier, the storage pool should contain only one tier of storage, and all of the MDisks in the storage pool should be similar and have similar performance characteristics.

Consider the following factors as you decide how many (storage pools) to create:

- A volume can only be created using the storage from one storage pool. Therefore, if you create small (storage pools), you might lose the benefits that are provided by virtualization, namely more efficient management of free space and a more evenly distributed workload for better performance.
- If any MDisk in an storage pool goes offline, all the (volumes) in the storage pool go offline. Therefore you might want to consider using different (storage pools) for different back-end controllers or for different applications.
- If you anticipate regularly adding and removing back-end controllers or storage, this task is made simpler by grouping all the MDisks that are presented by a back-end controller into one storage pool.
- All the MDisks in a storage pool should have similar levels of performance or reliability, or both. If a storage pool contains MDisks with different levels of performance, the performance of the (volumes) in this group is limited by the performance of the slowest MDisk. If a storage pool contains MDisks with different levels of reliability, the reliability of the (volumes) in this group is that of the least reliable MDisk in the group.

**Note:** When you create a storage pool with a new solid-state drive (SSD), the new SSD is automatically formatted and set to a block size of 512 bytes.

Even with the best planning, circumstances can change and you must reconfigure your (storage pools) after they have been created. The data migration facilities that are provided by the SAN Volume Controller enable you to move data without disrupting I/O.

### Choosing a storage pool extent size

Consider the following factors as you decide the extent size of each new storage pool:

- You must specify the extent size when you create a new storage pool.
- You cannot change the extent size later; it must remain constant throughout the lifetime of the storage pool.
- Storage pools can have different extent sizes; however, this places restrictions on the use of data migration.
- The choice of extent size affects the maximum size of a volume in the storage pool.

Table 6 compares the maximum volume capacity for each extent size. The maximum is different for thin-provisioned volumes. Because the SAN Volume Controller allocates a whole number of extents to each volume that is created, using a larger extent size might increase the amount of storage that is wasted at the end of each volume. Larger extent sizes also reduces the ability of the SAN Volume Controller to distribute sequential I/O workloads across many MDisks and therefore can reduce the performance benefits of virtualization.

*Table 6. Maximum volume capacity by extent size*

| Extent size (MB) | Maximum volume capacity in GB (not thin-provisioned volumes) | Maximum volume capacity in GB (thin-provisioned volumes) |
|------------------|--------------------------------------------------------------|----------------------------------------------------------|
| 16               | 2048 (2 TB)                                                  | 2000                                                     |
| 32               | 4096 (4 TB)                                                  | 4000                                                     |
| 64               | 8192 (8 TB)                                                  | 8000                                                     |
| 128              | 16,384 (16 TB)                                               | 16,000                                                   |
| 256              | 32,768 (32 TB)                                               | 32,000                                                   |
| 512              | 65,536 (64 TB)                                               | 65,000                                                   |

Table 6. Maximum volume capacity by extent size (continued)

| Extent size (MB) | Maximum volume capacity in GB (not thin-provisioned volumes) | Maximum volume capacity in GB (thin-provisioned volumes) |
|------------------|--------------------------------------------------------------|----------------------------------------------------------|
| 1024             | 131,072 (128 TB)                                             | 130,000                                                  |
| 2048             | 262,144 (256 TB)                                             | 260,000                                                  |
| 4096             | 262,144 (256 TB)                                             | 262,144                                                  |
| 8192             | 262,144 (256 TB)                                             | 262,144                                                  |

**Important:** You can specify different extent sizes for different (storage pools); however, you cannot migrate (volumes) between (storage pools) with different extent sizes. If possible, create all your (storage pools) with the same extent size.

Perform the following steps to create a storage pool:

Issue the **mkmdiskgrp** CLI command to create a storage pool.

The following is an example of the CLI command you can issue to create a storage pool:

```
mkmdiskgrp -name maindiskgroup -ext 32
 -mdisk mnsk0:mnsk1:mnsk2:mnsk3
```

where *maindiskgroup* is the name of the storage pool that you want to create, 32 MB is the size of the extent you want to use, and *mnsk0*, *mnsk1*, *mnsk2*, *mnsk3* are the names of the four MDisks that you want to add to the group.

You created and added MDisks to a storage pool.

The following example provides a scenario where you want to create a storage pool, but you do not have any MDisks available to add to the group. You plan to add the MDisks at a later time. You use the **mkmdiskgrp** CLI command to create the storage pool *bkpmdiskgroup* and later used the **addmdisk** CLI command to add *mnsk4*, *mnsk5*, *mnsk6*, *mnsk7* to the storage pool.

1. Issue `mkmdiskgrp -name bkpmdiskgroup -ext 32`  
where *bkpmdiskgroup* is the name of the storage pool that you want to create and 32 MB is the size of the extent that you want to use.
2. You find four MDisks that you want to add to the storage pool.
3. Issue `addmdisk -mdisk mnsk4:mnsk5:mnsk6:mnsk7 bkpmdiskgroup`  
where *mnsk4*, *mnsk5*, *mnsk6*, *mnsk7* are the names of the MDisks that you want to add to the storage pool and *bkpmdiskgroup* is the name of the storage pool for which you want to add MDisks.

---

## Adding MDisks to storage pools using the CLI

You can use the command-line interface (CLI) to add managed disks (MDisks) to storage pools.

The MDisks must be in unmanaged mode. Disks that already belong to a storage pool cannot be added to another storage pool until they have been deleted from their current storage pool. You can delete an MDisk from a storage pool under these circumstances:

- If the MDisk does not contain any extents in use by a virtual disk volume
- If you can first migrate the extents in use onto other free extents within the group

**Important:** Do not add an MDisk using this procedure if you are mapping the MDisk to an image mode volume. Adding an MDisk to a storage pool enables the SAN Volume Controller to write new data to the MDisk; therefore, any existing data on the MDisk is lost. If you want to create an image mode volume, use the **mkvdisk** command instead of **addmdisk**.

If you are using a SAN Volume Controller solid-state drive (SSD) managed disk, ensure that you are familiar with the SSD configuration rules.

When you are adding MDisks to a storage pool using the **addmdisk** command or when you are creating a storage pool using the **mkmdiskgrp -mdisk** command, the SAN Volume Controller performs tests on the MDisks in the list before the MDisks are allowed to become part of a storage pool. These tests include checks of the MDisk identity, capacity, status and the ability to perform both read and write operations. If these tests fail or exceed the time allowed, the MDisks are not added to the group. However, with the **mkmdiskgrp -mdisk** command, the storage pool is still created even if the tests fail, but it does not contain any MDisks. If tests fail, confirm that the MDisks are in the correct state and that they have been correctly discovered.

These events contribute to an MDisk test failure:

- The MDisk is not visible to all SAN Volume Controller nodes in the clustered system.
- The MDisk identity has changed from a previous discovery operation.
- The MDisk cannot perform read or write operations.
- The status of the MDisk can be either degraded paths, degraded ports, excluded, or offline.
- The MDisk does not exist.

These events contribute to an MDisk test timeout:

- The disk controller system on which the MDisk resides is failing.
- A SAN fabric or cable fault condition exists that is preventing reliable communication with the MDisk.

**Note:** The first time that you add a new solid-state drive (SSD) to a storage pool, the SSD is automatically formatted and set to a block size of 512 bytes.

Perform these steps to add MDisks to storage pools:

1. Issue the **lsmdiskgrp** CLI command to list the existing storage pools.

The following is an example of the CLI command you can issue to list the existing storage pools:

```
lsmdiskgrp -delim :
```

This is an example of the output that is displayed:

```
id:name:status:mdisk_count:vdisk_count:
capacity:extent_size:free_capacity:virtual_capacity:
used_capacity:real_capacity:overallocation:warning
0:mdiskgrp0:online:3:4:33.3GB:16:32.8GB:64.00MB:64.00MB:64.00MB:0:0
1:mdiskgrp1:online:2:1:26.5GB:16:26.2GB:16.00MB:16.00MB:16.00MB:0:0
2:mdiskgrp2:online:2:0:33.4GB:16:33.4GB:0.00MB:0.00MB:0.00MB:0:0
```

2. Issue the **addmdisk** CLI command to add MDisks to the storage pool.

This is an example of the CLI command you can issue to add MDisks to a storage pool:

```
addmdisk -mdisk mdisk4:mdisk5:mdisk6:mdisk7 bkpmdiskgroup
```

Where *mdisk4:mdisk5:mdisk6:mdisk7* are the names of the MDisks that you want to add to the storage pool and *bkpmdiskgroup* is the name of the storage pool for which you want to add the MDisks.

---

## Setting a quorum disk using the CLI

You can set an external managed disk (MDisk) as a quorum disk by using the command-line interface (CLI).

**Note:** Quorum functionality is not supported for internal drives on SAN Volume Controller nodes.

To set an MDisk as a quorum disk, use the **chquorum** command. **Storwize V7000:** To set an external MDisk as a quorum disk, use the **chquorum** command.

When setting an MDisk as a quorum disk, keep the following recommendations in mind:

- When possible, distribute the quorum candidate disks so that each MDisk is provided by a different storage system. For a list of storage systems that support quorum disks, refer to <http://www.ibm.com/support/docview.wss?uid=ssg1S1003703> ( <http://www.ibm.com/support/docview.wss?uid=ssg1S1003703>).
- Before you set the quorum disk with the **chquorum** command, use the **lsquorum** command to ensure that the MDisk you want is online.

**Storwize V7000:** Quorum disk configuration describes how quorum disks are used by the system, and how they are selected. The system automatically assigns quorum disks. Do not override the quorum disk assignment if you have a Storwize V7000 without external MDisks. For a Storwize V7000 with more than one control enclosure and with external MDisks, distribute the quorum candidate disks (when possible) so that each MDisk is provided by a different storage system. For a list of storage systems that support quorum disks, refer to <http://www.ibm.com/support/docview.wss?uid=ssg1S1003703> ( <http://www.ibm.com/support/docview.wss?uid=ssg1S1003703>).

## Modifying the amount of available memory for Copy Services and VDisk Mirroring features using the CLI

You can use the command-line interface (CLI) to modify the amount of memory that is available for the VDisk (Volume) Mirroring feature and the FlashCopy, Metro Mirror, or Global Mirror Copy Services features.

Table 7 provides an example of the amount of memory that is required for VDisk Mirroring and each Copy Service feature.

*Table 7. Memory required for VDisk Mirroring and Copy Services*

| Feature                       | Grain size | 1 MB of memory provides the following VDisk capacity for the specified I/O group |
|-------------------------------|------------|----------------------------------------------------------------------------------|
| Metro Mirror or Global Mirror | 256 KB     | 2 TB of total Metro Mirror and Global Mirror VDisk capacity                      |
| FlashCopy                     | 256 KB     | 2 TB of total FlashCopy source VDisk capacity                                    |
| FlashCopy                     | 64 KB      | 512 GB of total FlashCopy source VDisk capacity                                  |
| Incremental FlashCopy         | 256 KB     | 1 TB of total incremental FlashCopy source VDisk capacity                        |
| Incremental FlashCopy         | 64 KB      | 256 GB of total incremental FlashCopy source VDisk capacity                      |
| VDisk Mirroring               | 256 KB     | 2 TB of mirrored VDisk capacity                                                  |

**Notes:**

1. For multiple FlashCopy targets, you must consider the number of mappings. For example, for a mapping with a grain size of 256 KB, 8 KB of memory allows one mapping between a 16 GB source VDisk and a 16 GB target VDisk. Alternatively, for a mapping with a 256 KB grain size, 8 KB of memory allows two mappings between one 8 GB source VDisk and two 8 GB target VDIs.
2. When creating a FlashCopy mapping, if you specify an I/O group other than the I/O group of the source VDisk, the memory accounting goes towards the specified I/O group, not towards the I/O group of the source VDisk.
3. For VDisk Mirroring, the full 512 MB of memory space provides 1 PB of total VDisk Mirroring capacity.
4. In this table, *capacity* refers to the virtual capacity of the VDisk. For thin-provisioned volumes with different virtual capacities and real capacities, the virtual capacity is used for memory accounting.

Table 8 on page 24 provides an example of RAID level comparisons with their bitmap memory cost, where *MS* is the size of the member drives and *MC* is the number of member drives.

Table 8. RAID level comparisons

| Level   | Member count | Approximate capacity  | Redundancy | Approximate bitmap memory cost                                                     |
|---------|--------------|-----------------------|------------|------------------------------------------------------------------------------------|
| RAID-0  | 1-8          | MC * MS               | None       | (1 MB per 2 TB of MS) * MC                                                         |
| RAID-1  | 2            | MS                    | 1          | (1 MB per 2 TB of MS) * (MC/2)                                                     |
| RAID-5  | 3-16         | (MC-1) * MS           | 1          | 1 MB per 2 TB of MS with a strip size of 256 KB; double with strip size of 128 KB. |
| RAID-6  | 5-16         | less than (MC-2 * MS) | 2          |                                                                                    |
| RAID-10 | 2-16 (evens) | MC/2 * MS             | 1          | (1 MB per 2 TB of MS) * (MC/2)                                                     |

**Note:** There is a margin of error on the approximate bitmap memory cost of approximately 15%. For example, the cost for a 256 KB RAID-5 is ~1.15 MB for the first 2 TB of MS.

To modify and verify the amount of memory that is available, perform the following steps:

1. Issue the following command to modify the amount of memory that is available for VDisk Mirroring or a Copy Service feature:

```
chiogrp -feature flash|remote|mirror -size memory_size io_group_id | io_group_name
```

where *flash|remote|mirror* is the feature that you want to modify, *memory\_size* is the amount of memory that you want to be available, and *io\_group\_id* | *io\_group\_name* is the ID or name of the I/O group for which you want to modify the amount of available memory.

2. Issue the following command to verify that the amount of memory has been modified:

```
lsiogrp object_id | object_name
```

where *object\_id* | *object\_name* is the ID or name of the I/O group for which you have modified the amount of available memory.

The following information is an example of the output that is displayed.

```
id 0
name io_grp 0
node_count 2
vdisk_count 28
host_count 2
flash_copy_total_memory 20.0MB
flash_copy_free_memory 20.0MB
remote_copy_total_memory 20.0MB
remote_copy_free_memory 20.0MB
mirroring_total_memory 10.0MB
mirroring_free_memory 10.0MB
raid_total_memory 20.0MB
raid_free_memory 19.2MB
maintenance no <---
```

## Creating volumes using the CLI

You can use the command-line interface (CLI) to create a volume.

If the volume that you are creating maps to a solid-state drive (SSD), the data that is stored on the volume is not protected against SSD failures or node failures. To avoid data loss, add a volume copy that maps to an SSD on another node.

This task assumes that the clustered system has been set up and that you have created storage pools. You can establish an empty storage pool to hold the MDisks that are used for image mode volumes.

**Note:** If you want to keep the data on an MDisk, create image mode (volumes). This task describes how to create a volume with striped virtualization.



Perform the following steps to create volumes:

1. Issue the **lsmdiskgrp** CLI command to list the available storage pools and the amount of free storage in each group.

The following is an example of the CLI command you can issue to list storage pools:

```
lsmdiskgrp -delim :
```

The following is an example of the output that is displayed:

```
id:name:status:mdisk_count:vdisk_count:capacity:extent_size:free_capacity:virtual_capacity:
used_capacity:real_capacity:overallocation:warning:easy_tier:easy_tier_status
0:mdiskgrp0:degraded:4:0:34.2GB:16:34.2GB:0:0:0:0:0:auto:inactive
1:mdiskgrp1:online:4:6:200GB:16:100GB:400GB:75GB:100GB:200:80:on:active
```

2. Decide which storage pool you want to provide the storage for the volume.
3. Issue the **lsiogrp** CLI command to show the I/O groups and the number of volumes assigned to each I/O group.

**Note:** It is normal for clustered systems with more than one I/O group to have storage pools that have volumes in different I/O groups. You can use FlashCopy to make copies of volumes regardless of whether the source and target volume are in the same I/O group. If you plan to use intra-clustered system Metro Mirror or Global Mirror, both the master and auxiliary volume must be in the same I/O group.

The following is an example of the CLI command you can issue to list I/O groups:

```
lsiogrp -delim :
```

The following is an example of the output that is displayed:

```
id:name:node_count:vdisk_count:host_count
0:io_grp0:2:0:2
1:io_grp1:2:0:1
2:io_grp2:0:0:0
3:io_grp3:0:0:0
4:recovery_io_grp:0:0:0
```

4. Decide which I/O group you want to assign the volume to. This determines which SAN Volume Controller nodes in the clustered system process the I/O requests from the host systems. If you have more than one I/O group, make sure you distribute the volumes between the I/O groups so that the I/O workload is shared evenly between all SAN Volume Controller nodes.
5. Issue the **mkvdisk** CLI command to create a volume.

The rate at which the volume copies will resynchronize after loss of synchronization can be specified using the **syncrate** parameter. The following table defines the rates:

Table 9. Volume copy resynchronization rates

| Syncrate value | Data copied per second |
|----------------|------------------------|
| 1-10           | 128 KB                 |
| 11-20          | 256 KB                 |
| 21-30          | 512 KB                 |
| 31-40          | 1 MB                   |
| 41-50          | 2 MB                   |
| 51-60          | 4 MB                   |
| 61-70          | 8 MB                   |
| 71-80          | 16 MB                  |
| 81-90          | 32 MB                  |
| 91-100         | 64 MB                  |

The default setting is 50. The synchronization rate must be set such that the volume copies will resynchronize quickly after loss of synchronization.

When a mirrored volume uses disk extents on a solid-state drive (SSD) that is located on a SAN Volume Controller node, synchronization is lost if one of the nodes goes offline either during a concurrent code upgrade or because of maintenance. During code upgrade, the synchronization must be restored within 30 minutes or the upgrade stalls. Unlike volume copies from external storage systems, during the period that the SSD volume copies are not synchronized, access to the volume depends on the single node containing the SSD storage associated with the synchronized volume copy. The default synchronization rate is typically too low for SSD volume mirrors. Instead, set the synchronization rate to 80 or above.

The following is an example of the CLI command that you can issue to create a volume with two copies using the I/O group and storage pool name and specifying the synchronization rate:

```
mkvdisk -iogrp io_grp1 -mdiskgrp grpa:grpb -size500 -vtype striped
-copies 2 -syncrate 90
```

where *io\_grp1* is the name of the I/O group that you want the volume to use, *grpa* is the name of the storage pool for the primary copy of the volume and *grpb* is the name of the storage pool for the second copy of the volume, and 2 is the number of volume copies and the synchronization rate is 90 which is equivalent to 32MB per second.

The following is an example of the CLI command you can issue to create a volume using the I/O group ID and storage pool ID:

```
mkvdisk -name mainvdisk1 -iogrp 0
-mdiskgrp 0 -vtype striped -size 256 -unit gb
```

where *mainvdisk1* is the name that you want to call the volume, 0 is the ID of the I/O group that want the volume to use, 0 is the ID of the storage pool that you want the volume to use, and 256 is the capacity of the volume.

The following is an example of the CLI command that you can issue to create a volume using the I/O group and storage pool name:

```
mkvdisk -name bkpvdisk1 -iogrp io_grp1
-mdiskgrp bkpmdiskgroup -vtype striped -size 256 -unit gb
```

where *bkpvdisk1* is the name that you want to call the volume, *io\_grp1* is the name of the I/O group that want the volume to use, *bkpmdiskgroup* is the name of the storage pool that you want the volume to use, and 256 is the capacity of the volume.

The following is an example of the CLI command that you can issue to create a space-efficient volume using the I/O group and storage pool name:

```
mkvdisk -iogrp io_grp1 -mdiskgrp bkpmdiskgroup -vtype striped
-size 10 unit gb -rsize 20% -autoexpand -grainsize 32
```

where *io\_grp1* is the name of the I/O group that you want the volume to use and 20% is how much real storage to allocate to the volume, as a proportion of its virtual size. In this example, the size is 10 GB so that 2 GB will be allocated.

The following is an example of the CLI command that you can issue to create a volume with two copies using the I/O group and storage pool name:

```
mkvdisk -iogrp io_grp1 -mdiskgrp grpa:grpb
-size 500 -vtype striped -copies 2
```

where *io\_grp1* is the name of the I/O group that you want the volume to use, *grpa* is the name of the storage pool for the primary copy of the volume and *grpb* is the name of the storage pool for the second copy of the volume, and 2 is the number of volume copies.

**Note:** If you want to create two volume copies of different types, create the first copy using the **mkvdisk** command and then add the second copy using the **addvdiskcopy** command.

6. Issue the **lsvdisk** CLI command to list all the volumes that have been created.

---

## Adding a copy to a volume using the CLI

You can use the command-line interface (CLI) to add a mirrored copy to a volume. Each volume can have a maximum of two copies.

The **addvdiskcopy** command adds a copy to an existing volume, which changes a nonmirrored volume into a mirrored volume.

Creating mirrored copies of a volume allows the volume to remain accessible even when a managed disk (MDisk) that the volume depends on becomes unavailable. You can create copies of a volume either from different storage pools or by creating an image mode copy of the volume. Copies allow for availability of data; however, they are not separate objects. You can only create or change mirrored copies from the volume.

In addition, you can use volume mirroring as an alternative method of migrating volumes between storage pools. For example, if you have a nonmirrored volume in one storage pool and want to migrate that volume to a second storage pool, you can add a new copy of the volume by specifying the second storage pool for that volume copy. After the copies have synchronized, you can delete the copy in the first storage pool. The volume is migrated to the second storage pool while remaining online during the migration.

This alternative method of migrating volumes has the following advantages:

- Access to the volume data is not lost if the second storage pool goes offline during the migration.
- The speed of the migration can be adjusted, using the volume synchronization rate, and the migration can be paused.
- The migration can be ended by deleting the volume copy in the second storage pool before migration completes.
- The storage pools can have different extent sizes.

This alternative method has the following limitations:

- You cannot use this method for volumes that are already mirrored.
- There are more manual steps that are associated with this method.
- Write I/O performance is slightly affected during the migration, because the mirrored copies must be kept synchronized.

Use the **-copies** parameter to specify the number of copies to add to the volume; this is currently limited to the default value of **1** copy. Use the **-mdiskgrp** parameter to specify the managed disk group that will provide storage for the copy; the **lsmdiskgrp** CLI command lists the available managed disk groups and the amount of available storage in each group.

For image copies, you must specify the virtualization type using the **-vtype** parameter and an MDisk that is in unmanaged mode using the **-mdisk** parameter. This MDisk must be in the unmanaged mode. The **-vtype** parameter is optional for sequential (seq) and striped volumes. The default virtualization type is **striped**.

Use the **syncrate** parameter to specify the rate at which the volume copies will resynchronize after loss of synchronization. The topic that describes creating volumes using the CLI describes this parameter.

Issue the **addvdiskcopy** CLI command to add a mirrored copy to a volume:

```
addvdiskcopy -mdiskgrp 0 vdisk8
```

where *0* is the name of the managed disk group and *vdisk8* is the volume to which the copy will be added.

The command returns the IDs of the newly created volume copies.

---

## Deleting a copy from a volume using the CLI

You can use the command-line interface (CLI) to delete a mirrored copy from a volume.

If you are using solid-state drives (SSDs) that are inside a SAN Volume Controller node, always use volume mirroring with these SSDs. Data stored on SSDs inside SAN Volume Controller nodes is not protected against SSD failures or node failures. Therefore, if you are deleting a volume copy that uses a SSD, ensure that the data that is stored on the copy is protected with another volume copy.

The **rmvdiskcopy** CLI command deletes the specified copy from the specified volume. The command fails if all other copies of the volume are not synchronized; in this case, you must specify the **-force** parameter, delete the volume, or wait until the copies are synchronized. You must specify the **vdisk\_name|vdisk\_id** parameter last on the command line.

Issue the **rmvdiskcopy** CLI command to delete a mirrored copy from a volume:

```
rmvdiskcopy -copy 1 vdisk8
```

where *1* is the ID of the copy to delete and *vdisk8* is the virtual disk to delete the copy from.

The command does not return any output.

---

## Configuring host objects using the CLI

You can use command-line interface (CLI) to create host objects.

If you are configuring a host object on a Fibre Channel attached host, ensure that you have completed all zone and switch configuration. Also test the configuration to ensure that zoning was created correctly.

If you are configuring a host object on the cluster that uses iSCSI connections, ensure that you have completed the necessary host-system configurations and have configured the cluster for iSCSI connections.

At least one WWPN or iSCSI name must be specified.

Perform the following steps to create host objects:

1. Issue the **mkhost** CLI command to create a logical host object for a Fibre Channel attached host. Assign your worldwide port name (WWPN) for the host bus adapters (HBAs) in the hosts.

The following is an example of the CLI command that you can issue to create a Fibre Channel attached host:

```
mkhost -name new_name -hbawwpn wwpn_list
```

where *new\_name* is the name of the host and *wwpn\_list* is the WWPN of the HBA.

2. To create an iSCSI-attached host, issue the following CLI command:

```
mkhost -iscsiname iscsi_name_list
```

where *iscsi\_name\_list* specifies one or more iSCSI qualified names (IQNs) of this host. Up to 16 names can be specified, provided that the command-line limit is not reached. Each name should comply with the iSCSI standard, RFD 3720.

3. To add ports to a Fibre Channel attached host, issue the **addhostport** CLI command.

For example, issue the following CLI command:

```
addhostport -hbawwpn wwpn_list new_name
```

This command adds another HBA WWPN *wwpn\_list* to the host that was created in step 1 on page 28.

4. To add ports to an iSCSI-attached host, issue the **addhostport** CLI command.

For example, issue the following CLI command:

```
addhostport -iscsiname iscsi_name_list new_name
```

where *iscsi\_name\_list* Specifies the comma-separated list of IQNs to add to the host. This command adds an IQN to the host that was created in step 2 on page 28.

5. To set the Challenge Handshake Authentication Protocol (CHAP) secret that is used to authenticate the host for iSCSI I/O, issue the **chhost** CLI command. This secret is shared between the host and the cluster. For example, issue the following CLI command:

```
chhost -chapsecret chap_secret
```

where *chap\_secret* is the CHAP secret that is used to authenticate the host for iSCSI I/O. To list the CHAP secret for each host, use the **lsiscsiauth** command. To clear any previously set CHAP secret for a host, use the **chhost -nochapsecret** command.

After you have created the host object on the cluster, you can map volumes to a host.

If you are unable to discover the disk on the host system or if there are fewer paths available for each disk than expected, test the connectivity between your host system and the cluster. Depending on the connection type to the host, these steps might be different. For iSCSI-attached hosts, test your connectivity between the host and SAN Volume Controller ports by pinging SAN Volume Controller from the host. Ensure that the firewall and router settings are configured correctly and validate that the values for the subnet mask and gateway are specified correctly for the SAN Volume Controller host configuration.

For Fibre Channel attached hosts, ensure that the active switch configuration includes the host zone and check the host-port link status. To verify end-to-end connectivity, you can use the **lsfabric** CLI command or the View Fabric panel under Service and Maintenance container in the management GUI.

---

## Creating volume-to-host mappings using the CLI

You can use the command-line interface (CLI) to create volume-to-host mappings.

To create volume-to-host mappings (host mappings), follow these steps:

1. Issue the **mkvdiskhostmap** CLI command to create volume-to-host mappings.

The following is an example of the CLI command you can issue to create volume-to-host mappings:

```
mkvdiskhostmap -host demohost1 mainvdisk1
```

Where *demohost1* is the name of the host and *mainvdisk1* is the name of the volume.

2. After you have mapped volumes to hosts, discover the disks on the host system. This step requires that you access the host system and use the host-system utilities to discover the new disks that are made available by the SAN Volume Controller. You also have the option of creating a file system for those new disks. Consult your host-system documentation for more information on completing this task.

---

## Creating FlashCopy mappings using the CLI

You can use the command-line interface (CLI) to create FlashCopy mappings.

A FlashCopy mapping specifies the source and target virtual disk (VDisk) (volume). Source VDIs (volumes) and target VDIs (volumes) must meet the following requirements:

- They must be the same size.
- They must be managed by the same clustered system.

A VDisk (volume) can be the source in up to 256 mappings. A mapping is started at the point in time when the copy is required.

Perform the following steps to create FlashCopy mappings:

1. The source and target VDisk (volume) must be the exact same size. Issue the **lsvdisk -bytes** CLI command to find the size (capacity) of the VDisk (volume) in bytes.
2. Issue the **mkfcmap** CLI command to create a FlashCopy mapping.

The following CLI command example creates a FlashCopy mapping and sets the copy rate:

```
mkfcmap -source mainvdisk1 -target bkpvdisk1
-name main1copy -copyrate 75
```

Where *mainvdisk1* is the name of the source VDisk (volume), *bkpvdisk1* is the name of the VDisk (volume) that you want to make the target VDisk (volume), *main1copy* is the name that you want to call the FlashCopy mapping, and *75* is the copy rate.

The following is an example of the CLI command you can issue to create FlashCopy mappings without the copy rate parameter:

```
mkfcmap -source mainvdisk2 -target bkpvdisk2
-name main2copy
```

Where *mainvdisk2* is the name of the source VDisk (volume), *bkpvdisk2* is the name of the VDisk (volume) that you want to make the target VDisk (volume), *main2copy* is the name that you want to call the FlashCopy mapping.

**Note:** The default copy rate of 50 is used if you do not specify a copy rate.

If the specified source and target VDIs (volume) are also the target and source VDIs (volumes) of an existing mapping, the mapping that is being created and the existing mapping become partners. If one mapping is created as incremental, its partner is automatically incremental. A mapping can have only one partner.

3. Issue the **lsfcmap** CLI command to check the attributes of the FlashCopy mappings that have been created:

The following is an example of a CLI command that you can issue to view the attributes of the FlashCopy mappings:

```
lsfcmap -delim :
```

Where **-delim** species the delimiter. The following is an example of the output that is displayed:

```
id:name:source_vdisk_id:source_vdisk_name:target_vdisk_id:target_vdisk_name:
group_id:group_name:status:progress:copy_rate:clean_progress:incremental
0:main1copy:77:vdisk77:78:vdisk78:::idle_or_copied:0:75:100:off
1:main2copy:79:vdisk79:80:vdisk80:::idle_or_copied:0:50:100:off
```

## Preparing and starting a FlashCopy mapping using the CLI

Before you start the FlashCopy process using the command-line interface (CLI), you must prepare a FlashCopy mapping.

Starting a FlashCopy mapping creates a point-in-time copy of the data on the source virtual disk (VDisk) and writes it to the target VDisk (volume) for the mapping.

Perform the following steps to prepare and start a FlashCopy mapping:

1. Issue the **prestartfcmap** CLI command to prepare the FlashCopy mapping.

To run the following command, the FlashCopy mapping cannot belong to a consistency group.

```
prestartfcmap -restore main1copy
```

Where *main1copy* is the name of the FlashCopy mapping.

This command specifies the optional **restore** parameter, which forces the mapping to be prepared even if the target VDisk is being used as a source in another active FlashCopy mapping.

The mapping enters the preparing state and moves to the prepared state when it is ready.

2. Issue the **lsfcmap** CLI command to check the state of the mapping.

The following is an example of the output that is displayed:

```
lsfcmap -delim :
id:name:source_vdisk_id:source_vdisk_name:target_vdisk_id:
target_vdisk_name:group_id:group_name:status:progress:copy_rate
0:main1copy:0:main1disk1:1:bkpvdisk1:::prepared:0:50
```

3. Issue the **startfcmap** CLI command to start the FlashCopy mapping.

The following is an example of the CLI command you can issue to start the FlashCopy mapping:

```
startfcmap -restore main1copy
```

Where *main1copy* is the name of the FlashCopy mapping.

This command specifies the optional **restore** parameter, which forces the mapping to be started even if the target VDisk is being used as a source in another active FlashCopy mapping.

4. Issue the **lsfcmapprogress** CLI command with the FlashCopy mapping name or ID to check the progress of the mapping.

The following is an example of the output that is displayed; the FlashCopy mapping ID 0 is 47% completed.

```
lsfcmapprogress -delim :
id:progress
0:47
```

You have created a point-in-time copy of the data on a source VDisk and written that data to a target VDisk. The data on the target VDisk is only recognized by the hosts that are mapped to it.

## Stopping FlashCopy mappings using the CLI

You can use the command-line interface (CLI) to stop a FlashCopy mapping.

Follow these steps to stop a single stand-alone FlashCopy mapping.

1. To stop a FlashCopy mapping, issue the following **stopfcmap** command:

```
stopfcmap fc_map_id or fc_map_name
```

where *fc\_map\_id* or *fc\_map\_name* is the ID or name of the mapping to stop.

2. To stop immediately all processing associated with the mapping and break the dependency on the source VDisk (volume) of any mappings that are also dependent on the target disk, issue the following command:

```
stopfcmap -force -split fc_map_id or fc_map_name
```

When you use the **force** parameter, all FlashCopy mappings that depend on this mapping (as listed by the **lsfcmapdependentmaps** command) are also stopped. The **split** parameter can be specified only when stopping a map that has a progress of 100 as shown by the **lsfcmap** command. The **split** parameter removes the dependency of any other mappings on the source VDisk. It might be used prior to starting another FlashCopy mapping whose target disk is the source disk of the mapping being stopped. After the mapping is stopped with the **split** option, you can start the other mapping without the **restore** option.

## Deleting a FlashCopy mapping using the CLI

You can use the command-line interface (CLI) to delete a FlashCopy mapping.

The **rmfcmap** CLI command deletes an existing mapping if the mapping is in the `idle_or_copied` or `stopped` state. If it is in the `stopped` state, the **force** parameter is required to specify that the target VDisk (volume) is brought online. If the mapping is in any other state, you must stop the mapping before you can delete it.

If deleting the mapping splits the tree that contains the mapping, none of the mappings in either resulting tree can depend on any mapping in the other tree. To display a list of dependent FlashCopy mappings, use the **lsfcmapdependentmaps** command.

1. To delete an existing mapping, issue the **rmfcmap** CLI command:

```
rmfcmap fc_map_id or fc_map_name
```

where *fc\_map\_id* or *fc\_map\_name* is the ID or name of the mapping to delete.

2. To delete an existing mapping and bring the target VDisk online, issue the following command:

```
rmfcmap -force fc_map_id or fc_map_name
```

where *fc\_map\_id* or *fc\_map\_name* is the ID or name of the mapping to delete.

The command does not return any output.

---

## Creating a FlashCopy consistency group and adding mappings using the CLI

You can use the command-line interface (CLI) to create and add mappings to a FlashCopy consistency group.

If you have created several FlashCopy mappings for a group of virtual disks (volumes) that contain elements of data for the same application, it can be convenient to assign these mappings to a single FlashCopy consistency group. You can then issue a single prepare or start command for the whole group. For example, you can copy all of the files for a database at the same time.

Perform the following steps to add FlashCopy mappings to a new FlashCopy consistency group:

1. Issue the **mkfcconsistgrp** CLI command to create a FlashCopy consistency group.

The following is an example of the CLI command you can issue to create a FlashCopy consistency group:

```
mkfcconsistgrp -name FCcgrp0 -autodelete
```

Where **FCcgrp0** is the name of the FlashCopy consistency group. The **-autodelete** parameter specifies to delete the consistency group when the last FlashCopy mapping is deleted or removed from the consistency group.

2. Issue the **lsfcconsistgrp** CLI command to display the attributes of the group that you have created.

The following is an example of the CLI command you can issue to display the attributes of a FlashCopy consistency group:

```
lsfcconsistgrp -delim : FCcgrp0
```

The following is an example of the output that is displayed:

```
id:1
name:FCcgrp0
status:idle_or_copied
autodelete:on
FC_mapping_id:0
FC_mapping_name:fcmap0
FC_mapping_id:1
FC_mapping_name:fcmap1
```



**Note:** For any group that has just been created, the status reported is empty

3. Issue the **chfcmap** CLI command to add FlashCopy mappings to the FlashCopy consistency group:  
The following are examples of the CLI commands you can issue to add Flash Copy mappings to the FlashCopy consistency group:

```
chfcmap -consistgrp FCcgrp0 main1copy
chfcmap -consistgrp FCcgrp0 main2copy
```

Where **FCcgrp0** is the name of the FlashCopy consistency group and *main1copy*, *main2copy* are the names of the FlashCopy mappings.

4. Issue the **lsfcmap** CLI command to display the new attributes of the FlashCopy mappings.

The following is an example of the output that is displayed:

```
lsfcmap -delim :
id:name:source_vdisk_id:source_vdisk_name:target_vdisk_id:
target_vdisk_name:group_id:group_name:status:progress:copy_rate
0:main1copy:28:maindisk1:29:bkpdisk1:1:FCcgrp0:idle_copied::75
1:main2copy:30:maindisk2:31:bkpdisk2:1:FCcgrp0:idle_copied::50
```

5. Issue the **lsfcconsistgrp** CLI command to display the detailed attributes of the group.

The following is an example of a CLI command that you can issue to display detailed attributes:

```
lsfcconsistgrp -delim : FCcgrp0
```

Where **FCcgrp0** is the name of the FlashCopy consistency group, and **-delim** specifies the delimiter.

The following is an example of the output that is displayed:

```
id:1
name:FCcgrp0
status:idle_or_copied
autodelete:off
FC_mapping_id:0
FC_mapping_name:main1copy
FC_mapping_id:1
FC_mapping_name:main2copy
```

## Preparing and starting a FlashCopy consistency group using the CLI

You can use the command-line interface (CLI) to prepare and start a FlashCopy consistency group to start the FlashCopy process.

Successful completion of the FlashCopy process creates a point-in-time copy of the data on the source virtual disk (Vdisk) and writes it to the target VDisk (volume) for each mapping in the group. When you have assigned several mappings to a FlashCopy consistency group, you only have to issue a single prepare command to prepare every FlashCopy mapping in the group, and you only have to issue a single start command to start every FlashCopy mapping in the group.

Perform the following steps to prepare and start a FlashCopy consistency group:

1. Issue the **prestartfcconsistgrp** CLI command to prepare the FlashCopy consistency group before the copy process can be started.

**Remember:** You only have to issue a single prepare command for the whole group to prepare all of the mappings simultaneously.

The following is an example of the CLI command you can issue to prepare the FlashCopy consistency group:

```
prestartfcconsistgrp -restore maintobkpfcopy
```

Where *maintobkpfcopy* is the name of the FlashCopy consistency group.

The optional **restore** parameter forces the consistency group to be prepared even if the target VDisk of one of the mappings in the consistency group is being used as a source VDisk of another active

mapping. An active mapping is in the copying, suspended, or stopping state. The group enters the preparing state, and then moves to the prepared state when it is ready.

2. Issue the **lsfcconsistgrp** command to check the status of the FlashCopy consistency group.

The following is an example of the CLI command that you can issue to check the status of the FlashCopy consistency group.

```
lsfcconsistgrp -delim :
```

The following is an example of the output that is displayed:

```
id:name:status
1:maintobkpfcopy:prepared
```

3. Issue the **startfcconsistgrp** CLI command to start the FlashCopy consistency group to make the copy.

**Remember:** You only have to issue a single start command for the whole group to start all the mappings simultaneously.

The following is an example of the CLI command that you can issue to start the FlashCopy consistency group mappings:

```
startfcconsistgrp -prep -restore maintobkpfcopy
```

Where *maintobkpfcopy* is the name of the FlashCopy consistency group.

When you use the **prep** parameter, the system automatically issues the **prestartfcconsistgrp** command for the group that you specify. When the **restore** parameter is combined with the prep option, you force the consistency group to be started even if the target VDisk of one of the mappings in the consistency group is being used as a source VDisk in another active mapping. An active mapping is in the copying, suspended, or stopping state. The FlashCopy consistency group enters the copying state and returns to the idle\_copied state when complete.

4. Issue the **lsfcconsistgrp** command to check the status of the FlashCopy consistency group.

The following is an example of the CLI command that you can issue to check the status of the FlashCopy consistency group:

```
lsfcconsistgrp -delim : maintobkpfcopy
```

Where *maintobkpfcopy* is the name of the FlashCopy consistency group.

The following is an example of the output that is displayed when the process is still copying:

```
id:name:status
1:maintobkpfcopy:copying
```

The following is an example of the output that is displayed when the process has finished copying:

```
id:1
name:maintobkpfcopy
status:idle_copied
autodelete:off
FC_mapping_id:0
FC_mapping_name:main1copy
FC_mapping_id:1
FC_mapping_name:main2copy
```

## Stopping a FlashCopy consistency group using the CLI

You can use the command-line interface (CLI) to stop a FlashCopy consistency group.

The **stopfcconsistgrp** CLI command stops all processing that is associated with a FlashCopy consistency group that is in one of the following processing states: prepared, copying, stopping, or suspended.

1. To stop a FlashCopy consistency group, issue the **stopfcconsistgrp** CLI command:

```
stopfcconsistgrp fc_map_id or fc_map_name
```

where *fc\_map\_id* or *fc\_map\_name* is the ID or name of the mapping to delete.

2. To stop a consistency group and break the dependency on the source VDisks of any mappings that are also dependent on the target VDisk, issue the following command:

```
stopfcconsistgrp -split fc_map_id or fc_map_name
```

You can specify the **split** parameter when all the maps in the group have a progress of 100. It removes the dependency of any other maps on the source VDisks. You can use this option before you start another FlashCopy consistency group whose target disks are the source disks of the mappings that are being stopped. After the consistency group is stopped with the split option, you can start the other consistency group without the restore option

The command does not return any output.

## Deleting a FlashCopy consistency group using the CLI

You can use the command-line interface (CLI) to delete a FlashCopy consistency group.

The **rmfcconsistgrp** CLI command deletes an existing FlashCopy consistency group. The **force** parameter is required only when the consistency group that you want to delete contains mappings.

1. To delete an existing consistency group that does not contain mappings, issue the **rmfcconsistgrp** CLI command:

```
rmfcconsistgrp fc_map_id or fc_map_name
```

where *fc\_map\_id* or *fc\_map\_name* is the ID or name of the consistency group to delete.

2. To delete an existing consistency group that contains mappings that are members of the consistency group, issue the following command:

```
rmfcconsistgrp -force fc_map_id or fc_map_name
```

where *fc\_map\_id* or *fc\_map\_name* is the ID or name of the mapping to delete.

All the mappings that are associated with the consistency group are removed from the group and changed to stand-alone mappings. To delete a single mapping in the consistency group, you must use the **rmfcmap** command.

The command does not return any output.

---

## Creating Metro Mirror or Global Mirror relationships using the CLI

You can use the command-line interface (CLI) to create Metro Mirror or Global Mirror relationships.

To create Metro Mirror or Global Mirror relationships, perform these steps:

1. To create a Metro Mirror relationship, run the **mkrcrelationship** command. For example, enter:

```
mkrcrelationship -master master_vdisk_id
-aux aux_vdisk_id -cluster cluster_id
```

| Where *master\_vdisk\_id* is the ID of the master VDisk (volume), *aux\_vdisk\_id* is the ID of the auxiliary  
| VDisk, and *cluster\_id* is the ID of the remote clustered system.

2. To create a new Global Mirror relationship, run the **mkrcrelationship** command with the **-global** parameter. For example, enter:

```
mkrcrelationship -master master_vdisk_id
-aux aux_vdisk_id -cluster cluster_id -global
```

| Where *master\_vdisk\_id* is the ID of the master VDisk, *aux\_vdisk\_id* is the ID of the auxiliary VDisk, and  
| *cluster\_id* is the ID of the remote system.

## Modifying Metro Mirror or Global Mirror relationships using the CLI

You can use the command-line interface (CLI) to modify certain attributes of Metro Mirror or Global Mirror relationships. You can change only one attribute at a time for each command submission.

To modify Metro Mirror or Global Mirror relationships, run the **chrcrelationship** command.

1. Run the **chrrelationship** command to change the name of a Metro Mirror or Global Mirror relationship. For example, to change the relationship name, enter:  

```
chrrelationship -name new_rc_rel_name previous_rc_rel_name
```

 Where *new\_rc\_rel\_name* is the new name of the relationship and *previous\_rc\_rel\_name* is the previous name of the relationship.
2. Run the **chrrelationship** command to remove a relationship from whichever consistency group it is a member of. For example, enter:  

```
chrrelationship -force rc_rel_name/id
```

 Where *rc\_rel\_name/id* is the name or ID of the relationship.

## Starting and stopping Metro Mirror or Global Mirror relationships using the CLI

You can use the command-line interface (CLI) to start and stop stand-alone Metro Mirror and Global Mirror relationships. Relationships that are members of consistency groups must be started and stopped using the consistency group CLI commands.

To start and stop Metro Mirror or Global Mirror relationships, perform these steps:

1. To start a Metro Mirror or Global Mirror relationship, run the **startrcrelationship** command. For example, enter:  

```
startrcrelationship rc_rel_id
```

 Where *rc\_rel\_id* is the ID of the relationship that you want to start in a stand-alone relationship.
2. To stop a Metro Mirror or Global Mirror relationship, run the **stoprcrelationship** command. This command applies to a stand-alone relationship.  
 For example, enter:  

```
stoprcrelationship rc_rel_id
```

 Where *rc\_rel\_id* is the ID of the stand-alone relationship that you want to stop mirroring I/O.

## Displaying the progress of Metro Mirror or Global Mirror relationships using the CLI

You can use the command-line interface (CLI) to display the background copy of Metro Mirror or Global Mirror relationships as a percentage. When the initial background copy process for a relationship has completed, null is displayed for the progress of that relationship.

To display the progress of the background copy of Metro Mirror or Global Mirror relationships, run the **lsrrelationshipprogress** command.

1. To display data progress without headings for columns of data or for each item of data in a Metro Mirror or Global Mirror relationship, run the **lsrrelationshipprogress -nohdr** command. For example, to display data of the relationship with headings suppressed, enter:  

```
lsrrelationshipprogress -nohdr rc_rel_name
```

 Where *rc\_rel\_name* is the name of the specified object type.
2. To display the progress of a background copy of a Metro Mirror or Global Mirror relationship as a percentage, run the **lsrrelationshipprogress -delim** command. The colon character (:) separates all items of data in a concise view, and the spacing of columns does not occur. In a detailed view, the data is separated from its header by the specified delimiter. For example, enter:  

```
svcinform lsrrelationshipprogress -delim : 0
```

 The resulting output is displayed, such as in this example:

```
id:progress
0:58
```

## Switching Metro Mirror or Global Mirror relationships using the CLI

You can use the command-line interface (CLI) to reverse the roles of primary and secondary virtual disks (volumes) in a stand-alone Metro Mirror or Global Mirror relationship when that relationship is in a consistent state. Relationships that are members of consistency groups must be switched by using the consistency group CLI commands.

To switch the roles of primary and secondary VDisks in Metro Mirror or Global Mirror relationships, follow these steps:

1. To make the master disk in a Metro Mirror or Global Mirror relationship to be the primary, run the **switchrelationship -primary master** command. For example, enter:  

```
switchrelationship -primary master rc_rel_id
```

Where *rc\_rel\_id* is the ID of the relationship to switch.
2. To make the auxiliary disk in a Metro Mirror or Global Mirror relationship to be the primary, run the **switchrelationship -primary aux** command. For example, enter:  

```
switchrelationship -primary aux rc_rel_id
```

Where *rc\_rel\_id* is the ID of the relationship to switch.

## Deleting Metro Mirror and Global Mirror relationships using the CLI

You can use the command-line interface (CLI) to delete Metro Mirror and Global Mirror relationships.

To delete Metro Mirror and Global Mirror relationships, run the **rmrelationship** command. For example, enter:

```
rmrelationship rc_rel_name/id
```

where *rc\_rel\_name/id* is the name or ID of the relationship.

---

## Creating Metro Mirror or Global Mirror consistency groups using the CLI

You can use the command-line interface (CLI) to create Metro Mirror or Global Mirror consistency groups.

To create Metro Mirror or Global Mirror consistency groups, perform these steps:

1. To create a Metro Mirror or Global Mirror consistency group, run the **mkrconsistgrp** command. For example, enter:  

```
mkrconsistgrp -name new_name -cluster cluster_id
```

where *new\_name* is the name of the new consistency group and *cluster\_id* is the ID of the remote cluster for the new consistency group. If **-cluster** is not specified, a consistency group is created only on the local cluster. The new consistency group does not contain any relationships and will be in the empty state.
2. To add Metro Mirror or Global Mirror relationships to the group, run the **chrrelationship** command. For example, enter:  

```
chrrelationship -consistgrp consist_group_name rc_rel_id
```

where *consist\_group\_name* is the name of the new consistency group to assign the relationship to and *rc\_rel\_id* is the ID of the relationship.

## Modifying Metro Mirror or Global Mirror consistency groups using the CLI

You can use the command-line interface (CLI) to assign a new name or modify the name of an existing Metro Mirror or Global Mirror consistency group.

To assign or modify the name of a Metro Mirror or Global Mirror consistency group, run the **chrcconsistgrp** command.

1. Run the **chrcconsistgrp** command to assign a new name of a Metro Mirror or Global Mirror consistency group. For example, enter:

```
chrcconsistgrp -name new_name_arg
```

Where *new\_name\_arg* is the assigned new name of the consistency group.

2. Run the **chrcconsistgrp** command to change the name of the consistency group. For example, enter:

```
chrcconsistgrp -name new_consist_group_name previous_consist_group_name
```

Where *new\_consist\_group\_name* is the assigned new name of the consistency group and *previous\_consist\_group\_name* is the previous name of the consistency group.

## Starting and stopping Metro Mirror or Global Mirror consistency-group copy processes using the CLI

You can use the command-line interface (CLI) to start and stop Metro Mirror or Global Mirror consistency-group copy processes.

To start and stop Metro Mirror or Global Mirror consistency-group copy processes, perform these steps:

1. To start a Metro Mirror or Global Mirror consistency-group copy process, set the direction of copy if it is undefined and optionally mark the secondary VDIs of the consistency group as clean. Run the **startrcconsistgrp** command. For example, enter:

```
startrcconsistgrp rc_consist_group_id
```

Where *rc\_consist\_group\_id* is the ID of the consistency group to start processing.

2. To stop the copy process for a Metro Mirror or Global Mirror consistency group, run the **stoprcconsistgrp** command.

For example, enter:

```
stoprcconsistgrp rc_consist_group_id
```

Where *rc\_consist\_group\_id* is the ID of the consistency group that you want to stop processing.

If the group is in a consistent state, you can also use this command to enable write access to the secondary virtual disks (VDIs) in the group.

## Deleting Metro Mirror or Global Mirror consistency groups using the CLI

You can use the command-line interface (CLI) to delete Metro Mirror or Global Mirror consistency groups.

To delete existing Metro Mirror or Global Mirror consistency groups, follow these steps:

1. To delete a Metro Mirror or Global Mirror consistency group, run the **rmrcconsistgrp** command. For example, enter:

```
rmrcconsistgrp rc_consist_group_id
```

Where *rc\_consist\_group\_id* is the ID of the consistency group to delete.

2. If a Metro Mirror or Global Mirror consistency group is not empty, you must use the **-force** parameter to delete the consistency group. For example, enter:

```
rmrcconsistgrp -force rc_consist_group_id
```

Where *rc\_consist\_group\_id* is the ID of the consistency group to delete. This command causes all relationships that are members of the deleted group to become stand-alone relationships.

---

## Creating Metro Mirror and Global Mirror partnerships using the CLI

You can use the command-line interface (CLI) to create Metro Mirror and Global Mirror partnerships between two clusters.

Perform the following steps to create Metro Mirror and Global Mirror partnerships:

1. To create Metro Mirror and Global Mirror partnerships, run the **mkpartnership** command. For example, enter:

```
mkpartnership -bandwidth bandwidth_in_mbps remote_cluster_id
```

where *bandwidth\_in\_mbps* specifies the bandwidth (in megabytes per second) that is used by the background copy process between the clusters and *remote\_cluster\_id* is the ID of the remote cluster.

2. Run the **mkpartnership** command from the remote cluster. For example, enter:

```
mkpartnership -bandwidth bandwidth_in_mbps local_cluster_id
```

where *bandwidth\_in\_mbps* specifies the bandwidth (in megabytes per second) that is used by the background copy process between the clusters and *local\_cluster\_id* is the ID of the local cluster.

## Modifying Metro Mirror and Global Mirror partnerships using the CLI

You can use the command-line interface (CLI) to modify Metro Mirror and Global Mirror partnerships.

The partnership bandwidth, which is also known as *background copy*, controls the rate at which data is sent from the local clustered system to the remote clustered system. The partnership bandwidth can be changed to help manage the use of intersystem links. It is measured in megabytes per second (MBps).

Perform the following steps to modify Metro Mirror and Global Mirror partnerships:

1. To modify Metro Mirror and Global Mirror partnerships, run the **chpartnership** command. For example, enter:

```
chpartnership -bandwidth bandwidth_in_mbps remote_cluster_id
```

where *bandwidth\_in\_mbps* is the new bandwidth (in megabytes per second) from the local clustered system to the remote clustered system, and *remote\_cluster\_id* is the ID of the remote system.

2. Run the **chpartnership** command from the remote clustered system. For example, enter:

```
chpartnership -bandwidth bandwidth_in_mbps local_cluster_id
```

where *bandwidth\_in\_mbps* is the new bandwidth (in megabytes per second) from the remote clustered system to the local clustered system, and *local\_cluster\_id* is the ID of the local system.

## Starting and stopping Metro Mirror and Global Mirror partnerships using the CLI

You can use the command-line interface (CLI) to start and stop Metro Mirror and Global Mirror partnerships.

Perform the following steps to start and stop Metro Mirror and Global Mirror partnerships:

1. To start a Metro Mirror or Global Mirror partnership, run the **chpartnership** command from either cluster. For example, enter:

```
chpartnership -start remote_cluster_id
```

Where *remote\_cluster\_id* is the ID of the remote cluster. The **mkpartnership** command starts the partnership by default.

2. To stop a Metro Mirror or Global Mirror partnership, run the **chpartnership** command from either cluster.

For example, enter:

```
chpartnership -stop remote_cluster_id
```

Where *remote\_cluster\_id* is the ID of the remote cluster.

## Deleting Metro Mirror and Global Mirror partnerships using the CLI

You can use the command-line interface (CLI) to delete Metro Mirror and Global Mirror partnerships.

Perform the following steps to delete Metro Mirror and Global Mirror partnerships:

1. If a Metro Mirror or Global Mirror partnership has configured relationships or groups, you must stop the partnership before you can delete it. For example, enter:

```
chpartnership -stop remote_cluster_id
```

Where *remote\_cluster\_id* is the ID of the remote cluster.

2. To delete a Metro Mirror and Global Mirror partnership, run the **rmpartnership** command from either cluster. For example, enter:

```
rmpartnership remote_cluster_id
```

Where *remote\_cluster\_id* is the ID of the remote cluster.

---

## Determining the WWPNs of a node using the CLI

You can determine the worldwide port names (WWPNs) of a node using the command-line interface (CLI).

Perform the following steps to determine the WWPNs of a node:

1. Issue the **lsnode** CLI command to list the nodes in the cluster.
2. Record the name or ID of the node for which you want to determine the WWPNs.
3. Issue the **lsnode** CLI command and specify the node name or ID that was recorded in step 2.

The following is an example of the CLI command you can issue:

```
lsnode node1
```

Where *node1* is the name of the node for which you want to determine the WWPNs.

4. Record the four port IDs (WWPNs).

---

## Listing node-dependent volumes using the CLI

You can use the command-line interface (CLI) to list the volumes that are dependent on the status of a node.

If a node goes offline or is removed from a clustered system, all volumes that are dependent on the node go offline. Before taking a node offline or removing a node from a clustered system, run the **lsdependentvdisks** command to identify any node-dependent volumes.

By default, the **lsdependentvdisks** command also checks all available quorum disks. If the quorum disks are accessible only through the specified node, the command returns an error.

Various scenarios can produce node-dependent volumes. The following examples are common scenarios in which the **lsnodependentvdisks** command will return node-dependent volumes:

1. The node contains solid-state drives (SSDs) and also contains the only synchronized copy of a mirrored volume.
2. The node is the only node that can access an MDisk on the SAN fabric.
3. The other node in the I/O group is offline (all volumes in the I/O group are returned).
4. Pinned data in the cache is stopping the partner node from joining the I/O group.

To resolve (1), allow volume mirror synchronizations between SSD MDisks to complete. To resolve (2-4), bring any offline MDisks online and repair any degraded paths.

**Note:** The command lists the node-dependent volumes at the time the command is run; subsequent changes to a clustered system require running the command again.



1. Issue the **lsdependentvdisks** CLI command.

The following example shows the CLI format for listing the volumes that are dependent on node01:

```
lsdependentvdisks -drive -delim : 0:1
```

The following example shows the output that is displayed:

```
vdisk_id:vdisk_name
4:vdisk4
5:vdisk5
```

2. If the **lsdependentvdisks** command returns an error, you must move your quorum disks to MDisks that are accessible through all nodes. Rerun the command until no errors are returned.
3. Reissue the **lsdependentvdisks** command. When the command returns no volumes, the clustered system is free from any node-dependent volumes.

The following example shows the command syntax for listing the volumes that are dependent on node01:

```
lsdependentvdisks -node01 :
```

The following example shows the command output if there are no node-dependent volumes in the clustered system:

```
vdisk_id vdisk_name
```

---

## Determining the VDisk name from the device identifier on the host

You can use the command-line interface (CLI) to determine the virtual disk (VDisk) name from the device identifier on the host.

Each VDisk that is exported by the SAN Volume Controller is assigned a unique device identifier. The device identifier uniquely identifies the VDisk (volume) and can be used to determine which VDisk corresponds to the volume that the host sees.

Perform the following steps to determine the VDisk name from the device identifier:

1. Find the device identifier. For example, if you are using the subsystem device driver (SDD), the disk identifier is referred to as the virtual path (vpath) number. You can issue the following SDD command to find the vpath serial number:

```
datapath query device
```

For other multipathing drivers, refer to the documentation that is provided with your multipathing driver to determine the device identifier.

2. Find the host object that is defined to the SAN Volume Controller and corresponds with the host that you are working with.
  - a. Find the worldwide port numbers (WWPNs) by looking at the device definitions that are stored by your operating system. For example, on AIX the WWPNs are in the ODM and if you use Windows you have to go into the HBA Bios.
  - b. Verify which host object is defined to the SAN Volume Controller for which these ports belong. The ports are stored as part of the detailed view, so you must list each host by issuing the following CLI command:

```
lshost id | name
```

Where *name/id* is the name or ID of the host.

- c. Check for matching WWPNs.

3. Issue the following command to list the VDisk-to-host mappings:

```
lshostvdiskmap hostname
```

Where *hostname* is the name of the host.

4. Find the VDisk UID that matches the device identifier and record the VDisk name or ID.

---

## Determining the host that a VDisk (volume) is mapped to

You can determine the host that a virtual disk (VDisk) is mapped to using the command-line interface (CLI). To view the host mapping for a volume in the management GUI, select **Volumes > Volumes by Hosts**.

Perform the following steps to determine the host that the VDisk (volume) is mapped to:

1. Find the VDisk name or ID that you want to check.
2. Issue the following CLI command to list the hosts that this VDisk is mapped to:  

```
lsvdiskhostmap vdiskname/id
```

where *vdiskname/id* is the name or ID of the VDisk.
3. Find the host name or ID to determine which host this VDisk is mapped to.
  - If no data is returned, the VDisk is not mapped to any hosts.

---

## Determining the relationship between volumes and MDisks using the CLI

You can determine the relationship between volumes and managed disks (MDisks) using the command-line interface (CLI).

Select one or more of the following options to determine the relationship between volumes and MDisks:

- To display a list of the IDs that correspond to the MDisks that comprise the volume, issue the following CLI command:  

```
lsvdiskmember vdiskname/id
```

where *vdiskname/id* is the name or ID of the volume.
- To display a list of IDs that correspond to the volumes that are using this MDisk, issue the following CLI command:  

```
lsmdiskmember mdiskname/id
```

where *mdiskname/id* is the name or ID of the MDisk.
- To display a table of volume IDs and the corresponding number of extents that are being used by each volume, issue the following CLI command:  

```
lsmdiskextent mdiskname/id
```

where *mdiskname/id* is the name or ID of the MDisk.
- To display a table of MDisk IDs and the corresponding number of extents that each MDisk provides as storage for the given volume, issue the following CLI command:  

```
lsvdiskextent vdiskname/id
```

where *vdiskname/id* is the name or ID of the volume.

---

## Determining the relationship between MDisks and controller LUNs using the CLI

You can determine the relationship between managed disks (MDisks) and RAID arrays or LUNs using the command-line interface (CLI).

Each MDisk corresponds with a single RAID array, or with a single partition on a given RAID array. Each RAID controller defines a LUN number for this disk. The LUN number and controller name or ID are needed to determine the relationship between MDisks and RAID arrays or partitions.

Perform the following steps to determine the relationship between MDisks and RAID arrays:

1. Issue the following command to display a detailed view of the MDisk:

```
lsmdisk mdiskname
```

Where *mdiskname* is the name of the MDisk for which you want to display a detailed view.

2. Record the controller name or controller ID and the controller LUN number.
3. Issue the following command to display a detailed view of the controller:

```
lscontroller controllername
```

Where *controllername* is the name of the controller that you recorded in step 2.

4. Record the vendor ID, product ID, and WWNN. You can use this information to determine what is being presented to the MDisk.
5. From the native user interface for the given controller, list the LUNs it is presenting and match the LUN number with that noted in step 1 on page 42. This tells you the exact RAID array or partition that corresponds with the MDisk.

---

## Increasing the size of your clustered system using the CLI

You can increase throughput by adding more nodes to the clustered system. The nodes must be added in pairs and assigned to a new I/O group.

Perform the following steps to increase the size of your clustered system:

1. Add a node to your clustered system and repeat this step for the second node.
2. If you want to balance the load between the existing I/O groups and the new I/O groups, you can migrate your volumes to new I/O groups. Repeat this step for all volumes that you want to assign to the new I/O group.

## Adding a node to increase the size of a clustered system using the CLI

You can use the command-line interface (CLI) to increase the size of a clustered system by adding two nodes to create a new I/O group.

**Attention:** If you are adding a node that was previously removed from a clustered system, ensure that either the following two conditions have been met:

- The WWPN for the removed node is swapped with the node that replaces it.
- All hosts that accessed the removed node through its WWPNs have been reconfigured to use the WWPN for the new node.

Failure to do either of these action can result in data corruption.

Complete the following steps to add a node and increase the size of a clustered system:

1. Install the new nodes and connect to the Fibre Channel.
2. Issue the following command to verify that the node is detected on the fabric:  

```
lsnodecandidate
```
3. Using the front panel of the node, record the WWNN.
4. Issue the following command to determine the I/O group where the node should be added:  

```
lsiogrp
```
5. Record the name or ID of the first I/O group that has a node count of zero (0). You will need the ID for the next step.

**Note:** You only need to do this step for the first node that is added. The second node of the pair uses the same I/O group number.

6. Record the following information for future reference:
  - Node serial number.
  - Worldwide node name.
  - All of the worldwide port names.

- The name or ID of the I/O group that contains the node.
7. Issue the following command to add the node to the clustered system:  

```
addnode -wwnodename WWNN -iogrp newiogrpname/id [-name newnodename]
```

Where *WWNN* is the WWNN of the node, *newiogrpname/id* is the name or ID of the I/O group that you want to add the node to and *newnodename* is the name that you want to assign to the node. If you do not specify a new node name, a default name is assigned; however, it is recommended you specify a meaningful name.
  8. Record the following information for future reference:
    - Node serial number.
    - Worldwide node name.
    - All of the worldwide port names.
    - The name or ID of the I/O group that contains the node.
  9. Issue the following command to verify that the node is online:  

```
l snode
```

You may need to reconfigure your storage systems to allow the new I/O group nodes to access them. If the disk controller uses mapping to present RAID arrays or partitions to the clustered system and the WWNNs or the worldwide port names have changed, you must modify the port groups that belong to the clustered system.

## Migrating a volume to a new I/O group using the CLI

You can use the command-line interface (CLI) to migrate a volume to a new I/O group to increase the size of your clustered system.

You can migrate a volume to a new I/O group to manually balance the workload across the nodes in the clustered system. However, you might end up with a pair of nodes that are overworked and another pair that are not worked. Follow this procedure to migrate a single volume to a new I/O group. Repeat for other volumes as required.

**Attention:** This is a disruptive procedure. Access to the volume is lost while you follow this procedure. Migration commands fail if the target or source volume is offline, or if there is insufficient quorum disk space to store the metadata. Correct the offline or quorum disk condition and reissue the command.

Perform the following steps to migrate a single volume:

1. Quiesce all I/O operations for the volume. You might have to determine the hosts that are using this volume in advance.
2. Before migrating the volume, it is essential that for each device identifier that is presented by the volume you intend to move, the subsystem device driver (SDD) or other multipathing driver configuration is updated to remove the device identifiers. Failure to do this can result in data corruption. See the *IBM System Storage Multipath Subsystem Device Driver User's Guide* or the documentation that is provided with your multipathing driver for details about how to dynamically reconfigure device identifiers for the given host operating system.
3. Issue the following command to check if the volume is part of a relationship or mapping:

```
lsvdisk vdiskname/id
```

Where *vdiskname/id* is the name or ID of the volume.

- a. Find the **FC\_id** and **RC\_id** fields. If these are not blank, the volume is part of a mapping or relationship.
  - b. Stop or delete any FlashCopy mappings, Global Mirror, or Metro Mirror relationships that use this volume.
4. Issue the following command to migrate the volume:  

```
chvdisk -iogrp newiogrpname/id -node preferred_node vdiskname/id
```

where *preferred\_node* is the name of the node that you want to move the volume, *newiogrpname/id* is the name or ID of the I/O group where you want to migrate the volume and *vdiskname/id* is the name or ID of the volume that you want to migrate.

5. Discover the new device identifiers and check that each device identifier presents the correct number of paths. See the *IBM System Storage Multipath Subsystem Device Driver User's Guide* or the documentation that is provided with your multipathing driver for details about how to discover device identifiers for the given host operating system.

---

## Validating and repairing mirrored volume copies using the CLI

You can use the **repairvdiskcopy** command from the command-line interface (CLI) to validate and repair mirrored volume copies.

**Attention:** Run the **repairvdiskcopy** command only if all volume copies are synchronized.

When you issue the **repairvdiskcopy** command, you must use only one of the **-validate**, **-medium**, or **-resync** parameters. You must also specify the name or ID of the volume to be validated and repaired as the last entry on the command line. After you issue the command, no output is displayed.

### **-validate**

Use this parameter if you only want to verify that the mirrored volume copies are identical. If any difference is found, the command stops and logs an error that includes the logical block address (LBA) and the length of the first difference. You can use this parameter, starting at a different LBA each time to count the number of differences on a volume.

### **-medium**

Use this parameter to convert sectors on all volume copies that contain different contents into virtual medium errors. Upon completion, the command logs an event, which indicates the number of differences that were found, the number that were converted into medium errors, and the number that were not converted. Use this option if you are unsure what the correct data is, and you do not want an incorrect version of the data to be used.

### **-resync**

Use this parameter to overwrite contents from the specified primary volume copy to the other volume copy. The command corrects any differing sectors by copying the sectors from the primary copy to the copies being compared. Upon completion, the command process logs an event, which indicates the number of differences that were corrected. Use this action if you are sure that either the primary volume copy data is correct or that your host applications can handle incorrect data.

### **-startlba lba**

Optionally, use this parameter to specify the starting Logical Block Address (LBA) from which to start the validation and repair. If you previously used the **validate** parameter, an error was logged with the LBA where the first difference, if any, was found. Reissue **repairvdiskcopy** with that LBA to avoid reprocessing the initial sectors that compared identically. Continue to reissue **repairvdiskcopy** using this parameter to list all the differences.

Issue the following command to validate and, if necessary, automatically repair mirrored copies of the specified volume:

```
repairvdiskcopy -resync -startlba 20 vdisk8
```

### Notes:

1. Only one **repairvdiskcopy** command can run on a volume at a time.
2. Once you start the **repairvdiskcopy** command, you cannot use the command to stop processing.
3. The primary copy of a mirrored volume cannot be changed while the **repairvdiskcopy -resync** command is running.
4. If there is only one mirrored copy, the command returns immediately with an error.

5. If a copy being compared goes offline, the command is halted with an error. The command is not automatically resumed when the copy is brought back online.
6. In the case where one copy is readable but the other copy has a medium error, the command process automatically attempts to fix the medium error by writing the read data from the other copy.
7. If no differing sectors are found during **repairvdiskcopy** processing, an informational error is logged at the end of the process.

## Checking the progress of validation and repair of volume copies using the CLI

Use the **lsrepairvdiskcopyprogress** command to display the progress of mirrored volume validation and repairs. You can specify a volume copy using the **-copy id** parameter. To display the volumes that have two or more copies with an active task, specify the command with no parameters; it is not possible to have only one volume copy with an active task.

To check the progress of validation and repair of mirrored volumes, issue the following command:

```
lsrepairvdiskcopyprogress -delim :
```

The following example shows how the command output is displayed:

```
vdisk_id:vdisk_name:copy id:task:progress:estimated_completion_time
0:vdisk0:0:medium:50:070301120000
0:vdisk0:1:medium:50:070301120000
```

---

## Repairing a space-efficient volume using the CLI

You can use the **repairsevdiskcopy** command from the command-line interface to repair the metadata on a space-efficient volume.

The **repairsevdiskcopy** command automatically detects and repairs corrupted metadata. The command holds the volume offline during the repair, but does not prevent the disk from being moved between I/O groups.

If a repair operation completes successfully and the volume was previously offline because of corrupted metadata, the command brings the volume back online. The only limit on the number of concurrent repair operations is the number of virtual disk copies in the configuration.

When you issue the **repairsevdiskcopy** command, you must specify the name or ID of the volume to be repaired as the last entry on the command line. Once started, a repair operation cannot be paused or cancelled; the repair can only be terminated by deleting the copy.

**Attention:** Use this command only to repair a space-efficient volume (thin-provisioned volume) that has reported corrupt metadata.

Issue the following command to repair the metadata on a space-efficient volume:

```
repairsevdiskcopy vdisk8
```

After you issue the command, no output is displayed.

### Notes:

1. Because the volume is offline to the host, any I/O that is submitted to the volume while it is being repaired fails.
2. When the repair operation completes successfully, the corrupted metadata error is marked as fixed.
3. If the repair operation fails, the volume is held offline and an error is logged.

## Checking the progress of the repair of a space-efficient volume using the CLI

Issue the `lsrepairsevdiskcopyprogress` command to list the repair progress for space-efficient volume copies of the specified volume. If you do not specify a volume, the command lists the repair progress for all space-efficient copies in the system.

**Note:** Only run this command after you run the `repairsevdiskcopy` command, which you must only run as required by the fix procedures or by IBM support.

---

## Recovering from offline volumes using the CLI

If a node or an I/O group fails, you can use the command-line interface (CLI) to recover offline volumes.

If you have lost both nodes in an I/O group and have, therefore, lost access to all the volumes that are associated with the I/O group, you must perform one of the following procedures to regain access to your volumes. Depending on the failure type, you might have lost data that was cached for these volumes and the volumes are now offline.

### Data loss scenario 1

One node in an I/O group has failed and failover has started on the second node. During the failover process, the second node in the I/O group fails before the data in the write cache is written to hard disk. The first node is successfully repaired but its hardened data is not the most recent version that is committed to the data store; therefore, it cannot be used. The second node is repaired or replaced and has lost its hardened data, therefore, the node has no way of recognizing that it is part of the clustered system.

Perform the following steps to recover from an offline volume when one node has down-level hardened data and the other node has lost hardened data:

1. Recover the node and add it back into the system.
2. Delete all IBM FlashCopy mappings and Metro Mirror or Global Mirror relationships that use the offline volumes.
3. Run the `recovervdisk`, `recovervdiskbyiogrp` or `recovervdiskbycluster` command.
4. Re-create all FlashCopy mappings and Metro Mirror or Global Mirror relationships that use the volumes.

### Data loss scenario 2

Both nodes in the I/O group have failed and have been repaired. The nodes have lost their hardened data, therefore, the nodes have no way of recognizing that they are part of the system.

Perform the following steps to recover from an offline volume when both nodes have lost their hardened data and cannot be recognized by the system:

1. Delete all FlashCopy mappings and Metro Mirror or Global Mirror relationships that use the offline volumes.
2. Run the `recovervdisk`, `recovervdiskbyiogrp` or `recovervdiskbycluster` command.
3. Recreate all FlashCopy mappings and Metro Mirror or Global Mirror relationships that use the volumes.

## Recovering a node and returning it to the clustered system using the CLI

After a node or an I/O group fails, you can use the command-line interface (CLI) to recover a node and return it to the clustered system.

Perform the following steps to recover a node and return it to the clustered system:

1. Issue the following command to verify that the node is offline:  
`lsnode`
2. Issue the following command to remove the old instance of the offline node from the clustered system:  
`rmnode nodename/id`

Where *nodename/id* is the name or ID of the node.

3. Issue the following command to verify that the node can be seen on the fabric:  
`lsnodecandidate`

**Note:** Remember the worldwide node names (WWNNs) for each node because you will need them in the following step.

4. If the nodes are repaired by replacing the service controller, or the node is replaced, be sure to follow the replacement instructions for the specific node or controller. You will be instructed to reset the WWNN of the node to that of the original node. If you do not do that, you may need to reconfigure your SAN fabric, your hosts, and your storage systems.

**Attention:** If more than one I/O group is affected, ensure that you are adding the node to the same I/O group from which it was removed. Failure to do this can result in data corruption. Use the information that was recorded when the node was originally added to the clustered system. This can avoid a possible data corruption exposure if the node must be removed from and re-added to the clustered system. If you do not have access to this information, call the IBM Support Center to add the node back into the clustered system without corrupting the data. If you are adding the node into the clustered system for the first time, you must record the following information:

- Node serial number
- WWNN
- All WWPNs
- I/O group that contains the node

5. Issue the following command to add the node back into the clustered system:

```
addnode -wwnodename WWNN -iogrp
IOGRPNAME/ID [-name NODENAME]
```

Where *WWNN* is the worldwide node name, *IOGRPNAME/ID* is the I/O group name or ID and *NODENAME* is the name of the node.

In a service situation, a node should normally be added back into a clustered system using the original node name. As long as the partner node in the I/O group has not been deleted too, this is the default name used if **-name** is not specified.

6. Issue the following command to verify that the node is online:  
`lsnode`

## Recovering offline volumes using the CLI

You can recover offline volumes using the command-line interface (CLI).

Perform the following steps to recover offline volumes:

1. Issue the following CLI command to list all volumes that are offline and belong to an I/O group, enter:

```
lsvdisk -filtervalue IO_group_name=
IOGRPNAME/ID:status=offline
```

where *IOGRPNAME/ID* is the name of the I/O group that failed.

2. To acknowledge data loss for a volume with a *fast\_write\_state* of **corrupt** and bring the volume back online, enter:



```
recovervdisk vdisk_id | vdisk_name
```

where *vdisk\_id* | *vdisk\_name* is the name or ID of the volume.

**Notes:**

- If the specified volume is space-efficient or has space-efficient copies, the **recovervdisk** command starts the space-efficient repair process.
  - If the specified volume is mirrored, the **recovervdisk** command starts the resynchronization process.
3. To acknowledge data loss for all virtual disks in an I/O group with a *fast\_write\_state* of **corrupt** and bring them back online, enter:

```
recovervdiskbyiogrp io_group_id | io_group_name
```

where *io\_group\_id* | *io\_group\_name* is the name or ID of the I/O group.

**Notes:**

- If any volume is space-efficient or has space-efficient copies, the **recovervdiskbyiogrp** command starts the space-efficient repair process.
  - If any volume is mirrored, the **recovervdiskbyiogrp** command starts the resynchronization process.
4. To acknowledge data loss for all volumes in the clustered system with a *fast\_write\_state* of **corrupt** and bring them back online, enter:

```
recovervdiskbycluster
```

**Notes:**

- If any volume is space-efficient or has space-efficient copies, the **recovervdiskbycluster** command starts the space-efficient repair process.
- If any volume is mirrored, the **recovervdiskbycluster** command starts the resynchronization process.

## Moving offline volumes to their original I/O group using the CLI

You can move offline volumes to their original I/O group using the command-line interface (CLI).

After a node or an I/O group fails, you can use the following procedure to move offline volumes to their original I/O group.

**Attention:** Do not move volumes to an offline I/O group. Ensure that the I/O group is online before you move the volume back to avoid any further data loss.

Perform the following steps to move offline volumes to their original I/O group:

1. Issue the following command to move the volume back into the original I/O group:

```
chvdisk -iogrp IOGRPNAME/ID -force
vdiskname/ID
```

where *IOGRPNAME/ID* is the name or ID of the original I/O group and *vdiskname/ID* is the name or ID of the offline volume.

2. Issue the following command to verify that the volumes are now online:

```
lsvdisk -filtervalue IO_group_name=
IOGRPNAME/ID
```

where *IOGRPNAME/ID* is the name or ID of the original I/O group.

---

## Recording WWPN changes of replaced host HBAs

You can use the command-line interface (CLI) to record a change to a defined host object.

Because it is sometimes necessary to replace the host-bus adapter (HBA) that connects the host to the SAN, you must inform the SAN Volume Controller of the new worldwide port names (WWPNs) that this HBA contains.

Ensure that your switch is zoned correctly.

Perform the following steps to inform the SAN Volume Controller of a change to a defined host object:

1. Issue the following CLI command to list the candidate HBA ports:

```
lshbaportcandidate
```

You should see a list of the HBA ports that are available for addition to host objects. One or more of these HBA ports should correspond with the one or more WWPNs that belong to the new HBA port.

2. Locate the host object that corresponds with the host in which you have replaced the HBA. The following CLI command lists all the defined host objects:

```
lshost
```

3. Issue the following CLI command to list the WWPNs that are currently assigned to the host object:

```
lshost hostobjectname
```

where *hostobjectname* is the name of the host object.

4. Issue the following CLI command to add the new ports to the existing host object:

```
addhostport -hbawwpn one or more existing WWPNs
separated by : hostobjectname/ID
```

where *one or more existing WWPNs separated by :* is the WWPNs that are currently assigned to the host object and *hostobjectname/ID* is the name or ID of the host object.

5. Issue the following CLI command to remove the old ports from the host object:

```
rmhostport -hbawwpn one or more existing WWPNs
separated by : hostobjectname/ID
```

where *one or more existing WWPNs separated by :* is the WWPNs that are currently assigned to the host object and *hostobjectname/ID* is the name or ID of the host object.

Any mappings that exist between the host object and the virtual disks (VDisks) are automatically applied to the new WWPNs. Therefore, the host sees the VDisks as the same SCSI LUNs as before.

See the *IBM System Storage Multipath Subsystem Device Driver User's Guide* or the documentation that is provided with your multipathing driver for additional information about dynamic reconfiguration.

---

## Expanding VDisks (volumes) using the CLI

You can use the command-line interface (CLI) to expand a virtual disk (VDisk).

VDisks (volumes) that are mapped for FlashCopy or that are in Metro Mirror relationships cannot be expanded.

Ensure that you have run Windows Update and have applied all recommended updates to your system before you attempt to expand a VDisk that is mapped to a Windows host.

Determine the exact size of the source or master VDisk by issuing the following CLI command:

```
svcinfo lsvdisk -bytes vdiskname
```

where *vdiskname* is the name of the VDisk for which you want to determine the exact size.

VDisks can be expanded under Windows concurrently with I/O operations.

You can expand VDisks for the following reasons:

- To increase the available capacity on a particular VDisk that is already mapped to a host.
- To increase the size of a VDisk so that it matches the size of the source or master VDisk and so that it can be used in a FlashCopy mapping or Metro Mirror relationship.

A VDisk that is not mapped to any hosts and does not contain any data can be expanded at any time. If the VDisk contains data that is in use, you can expand the VDisks if your host has a supported AIX or Microsoft Windows operating system.

The following table provides the supported operating systems and requirements for expanding VDisks that contain data:

| Operating system     | Supported | Requirement                   |
|----------------------|-----------|-------------------------------|
| AIX                  | Yes       | AIX version 5.2 or later      |
| HP-UX                | No        | -                             |
| Linux                | No        | -                             |
| SUN Solaris          | No        | -                             |
| Microsoft Windows NT | No        | -                             |
| Microsoft Windows    | Yes       | Windows version 2000 or later |

## Expanding a VDisk (volume) that is mapped to an AIX host

The SAN Volume Controller supports the ability to dynamically expand the size of a virtual disk (VDisk) if the AIX host is using AIX version 5.2 or later.

The **chvg** command options provide the ability to expand the size of a physical volume that the Logical Volume Manager (LVM) uses, without interruptions to the use or availability of the system. See the *AIX System Management Guide Operating System and Devices* for more information.

## Expanding a volume that is mapped to a Microsoft Windows host using the CLI

You can use the command-line interface (CLI) to dynamically expand the size of a volume that is mapped to a Microsoft Windows host.

Perform the following steps to expand a volume that is mapped to a Windows host:

1. Issue the following CLI command to expand the volume:

```
expandvdisksize -size disk_size -unit
 b | kb | mb | gb | tb | pb vdisk_name/vdisk_id
```

where *disk\_size* is the capacity by which you want to expand the volume, *b | kb | mb | gb | tb | pb* is the data unit to use in conjunction with the capacity and *vdisk\_name/vdisk\_id* is the name of the volume or the ID of the volume to expand.

2. On the Windows host, start the Computer Management application and open the Disk Management window under the Storage branch.

You will see the volume that you expanded now has some unallocated space at the end of the disk.

You can expand dynamic disks without stopping I/O operations in most cases. However, in some applications the operating system might report I/O errors. When this problem occurs, either of the following entries might be recorded in the System event log:

```
Event Type: Information
Event Source: dmio
Event Category: None
Event ID: 31
```

Description: dmio:  
Harddisk0 write error at block ##### due to  
disk removal

Event Type: Information  
Event Source: dmio  
Event Category: None  
Event ID: 34  
Description: dmio:  
Harddisk0 is re-online by PnP

**Attention:** This is a known problem with Windows 2000 and is documented in the Microsoft knowledge base as article Q327020. If either of these errors are seen, run Windows Update and apply the recommended fixes to resolve the problem.

If the Computer Management application was open before you expanded the volume, use the Computer Management application to issue a rescan command.

If the disk is a Windows basic disk, you can create a new primary or extended partition from the unallocated space.

If the disk is a Windows dynamic disk, you can use the unallocated space to create a new volume (simple, striped, mirrored) or add it to an existing volume.

---

## Shrinking a volume using the CLI

You can reduce the size of a volume using the command-line interface (CLI).

Volumes can be reduced in size, if it is necessary. You can make a target or auxiliary volume the same size as the source or master volume when you create FlashCopy mappings, Metro Mirror relationships, or Global Mirror relationships. However, if the volume contains data, do not shrink the size of the disk.

### Attention:

1. The SAN Volume Controller arbitrarily reduces the capacity of the volume by removing one or more extents from those that are allocated to the volume. You cannot control which extents are removed so you cannot guarantee that it is unused space that is removed.
2. If the volume contains data that is being used, *do not attempt under any circumstances to shrink a volume without first backing up your data.*
3. For performance reasons, some operating systems or file systems use the outer edge of the disk.

You can use the **shrinkvdisksize** command to shrink the physical capacity that is allocated to the particular volume by the specified amount. You can also shrink the virtual capacity of a thin-provisioned volume without altering the physical capacity assigned to the volume.

For more information about the command parameters, see the *IBM System Storage SAN Volume Controller and IBM Storwize V7000 Command-Line Interface User's Guide*.

Perform the following steps to shrink a volume:

1. Validate that the volume is not mapped to any host objects. If the volume is mapped, data is displayed.
2. You can determine the exact capacity of the source or master volume. Issue the following command:

```
lsvdisk -bytes vdiskname
```

3. Shrink the volume by the required amount. Issue the following command:

```
shrinkvdisksize -size capacitytoshrinkby -unit
unitsforreduction vdiskname/ID
```

---

## Migrating extents using the CLI

To improve performance, you can migrate extents using the command-line interface (CLI).

The SAN Volume Controller provides various data migration features. These can be used to move the placement of data both *within* storage pools and *between* storage pools. These features can be used concurrently with I/O operations. You can use either of these methods to migrate data:

1. Migrating data (extents) from one MDisk to another (within the same storage pool). This can be used to remove highly utilized MDisks.
2. Migrating volumes from one storage pool to another. This can be used to remove highly utilized storage pools. For example, you can reduce the utilization of a group of MDisks.

Migration commands fail if the target or source volume is offline, or if there is insufficient quorum disk space to store the metadata. Correct the offline or quorum disk condition and reissue the command.

You can determine the usage of particular MDisks by gathering input/output (I/O) statistics about nodes, MDisks, and volumes. After you have gathered this data, you can analyze it to determine which MDisks are highly utilized. The procedure then takes you through querying and migrating extents to elsewhere in the same storage pool. This procedure can only be performed using the command-line tools.

If performance monitoring tools, such as IBM Tivoli Storage Productivity Center, indicate that a managed disk in the pool is being overutilized, you can migrate some of the data onto other MDisks within the same storage pool.

1. Determine the number of extents that are in use by each volume for the given MDisk by issuing this CLI command:

```
lsmdiskextent mdiskname
```

This command returns the number of extents that each volume is using on the given MDisk. You should pick some of these to migrate elsewhere in the group.

2. Determine the other MDisks that reside in the same storage pool.
  - a. To determine the storage pool that the MDisk belongs to, issue this CLI command:

```
lsmdisk mdiskname | ID
```

- b. List the MDisks in the group by issuing this CLI command:

```
lsmdisk -filtervalue mdisk_grp_name=mdiskgrpname
```

3. Select one of these MDisks as the target MDisk for the extents. You can determine how many free extents exist on an MDisk by issuing this CLI command:

```
lsfreeextents mdiskname
```

You can issue the **lsmdiskextent** *newmdiskname* command for each of the target MDisks to ensure that you are not just moving the over-utilization to another MDisk. Check that the volume that owns the set of extents to be moved does not already own a large set of extents on the target MDisk.

4. For each set of extents, issue this CLI command to move them to another MDisk:

```
migrateexts -source mdiskname | ID -exts num_extents
-target newmdiskname | ID -threads 4 vdiskid
```

where *num\_extents* is the number of extents on the *vdiskid*. The *newmdiskname* | *ID* value is the name or ID of the MDisk to migrate this set of extents to.

**Note:** The number of threads indicates the priority of the migration processing, where **1** is the lowest priority and **4** is the highest priority.

5. Repeat the previous steps for each set of extents that you are moving.
6. You can check the progress of the migration by issuing this CLI command:

```
lsmigrate
```

---

## Migrating volumes between storage pools using the CLI

You can migrate volumes between storage pools using the command-line interface (CLI).

You can determine the usage of particular MDisks by gathering input/output (I/O) statistics about nodes, MDisks, and volumes. After you have gathered this data, you can analyze it to determine which volumes or MDisks are hot. You can then migrate volumes from one storage pool to another.

Perform the following step to gather statistics about MDisks and volumes:

1. Use secure copy (**scp** command) to retrieve the dump files for analyzing. For example, issue the following:

```
scp clusterip:/dumps/iostats/v_*
```

This copies all the volume statistics files to the AIX host in the current directory.

2. Analyze the dumps to determine which volumes are hot. It might be helpful to also determine which MDisks are being used heavily as you can spread the data that they contain more evenly across all the MDisks in the group by migrating the extents.

After you analyze the I/O statistics data, you can determine which volumes are hot. You also need to determine the storage pool that you want to move this volume to. Either create a new storage pool or determine an existing group that is not yet overly used. To do this, check the I/O statistics files that you generated and then ensure that the MDisks or VDIsks in the target storage pool are used less than those in the source group.

You can use data migration or volume mirroring to migrate data between MDisk groups. Data migration uses the command **migratevdisk**. Volume mirroring uses the commands **addvdiskcopy** and **rmvdiskcopy**.

When you issue the **migratevdisk** command, a check is made to ensure that the destination of the migration has enough free extents to satisfy the command. If it does, the command proceeds. The command takes some time to complete.

### Notes:

- You cannot use the SAN Volume Controller data migration function to move a volume between storage pools that have different extent sizes.
- Migration commands fail if the target or source volume is offline, or if there is insufficient quorum disk space to store the metadata. Correct the offline or quorum disk condition and reissue the command.

When you use data migration, it is possible for the free destination extents to be consumed by another process; for example, if a new volume is created in the destination storage pool or if more migration commands are started. In this scenario, after all the destination extents are allocated, the migration commands suspend and an error is logged (error ID 020005). To recover from this situation, use either of the following methods:

- Add additional MDisks to the target storage pool. This provides additional extents in the group and allows the migrations to be restarted. You must mark the error as fixed before you reattempt the migration.
- Migrate one or more VDIsks that are already created from the storage pool to another group. This frees up extents in the group and allows the original migrations to be restarted.

Perform the following steps to use the **migratevdisk** command to migrate volumes between storage pools:

1. After you determine the volume that you want to migrate and the new storage pool you want to migrate it to, issue the following CLI command:

```
migratevdisk -vdisk vdiskname/ID -mdiskgrp
newmdiskgrname/ID -threads 4
```

2. You can check the progress of the migration by issuing the following CLI command:

```
lsmigrate
```

When you use data migration, the volume goes offline if either storage pool fails. Volume mirroring can be used to minimize the impact to the volume because the volume goes offline only if the source storage pool fails.

Perform the following steps to use volume mirroring to migrate volumes between storage pool:

1. After you determine the volume that you want to migrate and the new storage pool that you want to migrate it to, issue the following command:

```
addvdiskcopy -mdiskgrp newmdiskgrname/ID vdiskname/ID
```

2. The copy ID of the new copy is returned. The copies now synchronize such that the data is stored in both storage pools. You can check the progress of the synchronization by issuing the following command:

```
lsvdisksyncprogress
```

3. After the synchronization is complete, remove the copy from the original I/O group to free up extents and decrease the utilization of the storage pool. To remove the original copy, issue the following command:

```
rmvdiskcopy -copy original copy id vdiskname/ID
```

---

## Migrating a volume between I/O groups using the CLI

Ensure that you are familiar with migrating a volume between I/O groups.

### Attention:

- These migration tasks are disruptive. The cached data that is held within the clustered system must first be written to disk before the allocation of the volume can be changed.
- Migration commands fail if the target or source volume is offline, or if there is insufficient quorum disk space to store the metadata. Correct the offline or quorum disk condition and reissue the command.

Modifying the I/O group that services the volume cannot be done concurrently with I/O operations. It also requires a rescan at the host level to ensure that the multipathing driver is notified that the allocation of the preferred node has changed and the ports by which the volume is accessed has changed. This should only be done in the situation where one pair of nodes has become over utilized.

Perform the following steps to migrate a volume between I/O groups:

1. Synchronize all file systems that are mounted on the given volume.
2. Stop all I/O operations to the volume.
3. Issue the following CLI command to migrate the volume into a new I/O group:

```
chvdisk -iogrp iogrp_name_or_id -node preferred_node vdisk
```

where *iogrp\_name\_or\_id* is the name or ID of the I/O group that you want to migrate the volume to, *preferred\_node* is the name of the node that you want to move the volume to, and *vdisk* is the name of the volume that you want to migrate.

4. Resynchronize the volume to host mapping. See the *IBM System Storage Multipath Subsystem Device Driver User's Guide* or the documentation that is provided with your multipathing driver for more information.

5. Restart the I/O operations to the volume.

---

## Creating an image mode volume using the CLI

You can use the command-line interface (CLI) to import storage that contains existing data and continue to use this storage. You can also use the advanced functions, such as Copy Services, data migration, and the cache. These disks are known as image mode virtual volumes.

Make sure you are aware of the following before you create image mode volumes:

1. Unmanaged-mode managed disks (MDisks) that contain existing data cannot be differentiated from unmanaged-mode MDisks that are blank. Therefore, it is vital that you control the introduction of these MDisks to the clustered system by adding these disks one at a time. For example, map a single LUN from your RAID storage system to the clustered system and refresh the view of MDisks. The newly detected MDisk is displayed.
2. *Do not* manually add an unmanaged-mode MDisk that contains existing data to a storage pool. If you do, the data is lost. When you use the command to convert an image mode volume from an unmanaged-mode disk, you will select the storage pool where it should be added.

See the following website for more information:

Support for SAN Volume Controller (2145) website at [www.ibm.com/storage/support/2145](http://www.ibm.com/storage/support/2145)

Perform the following steps to create an image mode volume:

1. Stop all I/O operations from the hosts. Unmap the logical disks that contain the data from the hosts.
2. Create one or more storage pools.
3. Map a single array or logical unit from your RAID storage system to the clustered system. You can do this through a switch zoning or a RAID storage system based on your host mappings. The array or logical unit appears as an unmanaged-mode MDisk to the SAN Volume Controller.
4. Issue the **lsmdisk** command to list the unmanaged-mode MDisks.

If the new unmanaged-mode MDisk is not listed, you can perform a fabric-level discovery. Issue the **detectmdisk** command to scan the Fibre Channel network for the unmanaged-mode MDisks.

**Note:** The **detectmdisk** command also rebalances MDisk access across the available storage system device ports.

5. Convert the unmanaged-mode MDisk to an image mode virtual disk.

**Note:** If the volume that you are converting maps to a solid-state drive (SSD), the data that is stored on the volume is not protected against SSD failures or node failures. To avoid data loss, add a volume copy that maps to an SSD on another node.

Issue the **mkvdisk** command to create an image mode virtual disk object.

6. Map the new volume to the hosts that were previously using the data that the MDisk now contains. You can use the **mkvdiskhostmap** command to create a new mapping between a volume and a host. This makes the image mode volume accessible for I/O operations to the host.

After the volume is mapped to a host object, the volume is detected as a disk drive with which the host can perform I/O operations.

If you want to virtualize the storage on an image mode volume, you can transform it into a striped volume. Migrate the data on the image mode volume to managed-mode disks in another storage pool. Issue the **migrateevdisk** command to migrate an entire image mode volume from one storage pool to another storage pool.



---

## Migrating data to an image mode virtual disk using the CLI

You can use the command-line interface (CLI) to migrate data to an image mode virtual disk (VDisk).

The **migratetoimage** CLI command allows you to migrate the data from an existing VDisk (volume) onto a different managed disk (MDisk).

When the **migratetoimage** CLI command is issued, it migrates the data of the user specified source VDisk onto the specified target MDisk. When the command completes, the VDisk is classified as an image mode VDisk.

**Note:** Migration commands fail if the target or source VDisk is offline, or if there is insufficient quorum disk space to store the metadata. Correct the offline or quorum disk condition and reissue the command.

The MDisk specified as the target must be in an unmanaged state at the time the command is run. Issuing this command results in the inclusion of the MDisk into the user specified MDisk group.

Issue the following CLI command to migrate data to an image mode VDisk:

```
migratetoimage -vdisk vdiskname/ID
 -mdisk newmdiskname/ID -mdiskgrp newmdiskgrpname/ID
 -threads 4
```

where *vdiskname/ID* is the name or ID of the VDisk, *newmdiskname/ID* is the name or ID of the new MDisk, and *newmdiskgrpname/ID* is the name or ID of the new MDisk group (storage pool).

---

## Deleting a node from a clustered system using the CLI

You can use the command-line interface (CLI) to remove a node from a clustered system.

After the node is deleted, the other node in the I/O group enters write-through mode until another node is added back into the I/O group.

By default, the **rmnode** command flushes the cache on the specified node before taking the node offline. When operating in a degraded state, the SAN Volume Controller ensures that data loss does not occur as a result of deleting the only node with the cache data.

**Attention:**

- If you are removing a single node and the remaining node in the I/O group is online, the data can be exposed to a single point of failure if the remaining node fails.
- If both nodes in the I/O group are online and the volumes are already degraded before deleting the node, redundancy to the volumes is already degraded. Removing a node might result in loss of access to data, and data loss might occur if the **force** option is used.
- Removing the last node in the clustered system destroys the clustered system. Before you delete the last node in the clustered system, ensure that you want to destroy the clustered system.
- When you delete a node, you remove all redundancy from the I/O group. As a result, new or existing failures can cause I/O errors on the hosts. The following failures can occur:
  - Host configuration errors
  - Zoning errors
  - Multipathing software configuration errors
- If you are deleting the last node in an I/O group and there are volumes assigned to the I/O group, you cannot delete the node from the clustered system if the node is online. You must back up or migrate all data that you want to save before you delete the node. If the node is offline, you can delete the node.
- To take the specified node offline immediately without flushing the cache or ensuring that data loss does not occur, run the **rmnode** command with the **force** parameter. The **force** parameter forces continuation of the command even though any node-dependent volumes will be taken offline. Use the **force** parameter with caution; access to data on node-dependent volumes will be lost.

Perform the following steps to delete a node:

1. If you are deleting the last node in an I/O group, determine the volumes that are still assigned to this I/O group:
  - a. Issue the following CLI command to request a filtered view of the volumes:

```
lsvdisk -filtervalue IO_group_name=name
```

Where *name* is the name of the I/O group.
  - b. Issue the following CLI command to list the hosts that this volume is mapped to:

```
lsvdiskhostmap vdiskname/id
```

Where *vdiskname/id* is the name or ID of the volume.

**Note:** If volumes are assigned to this I/O group that contain data that you want to continue to access, back up the data or migrate the volumes to a different (online) I/O group.

2. If this node is *not* the last node in the clustered system, turn off the power to the node that you intend to remove. This step ensures that the multipathing device driver, such as the subsystem device driver (SDD), does not rediscover the paths that are manually removed before you issue the delete node request.

**Attention:**

- a. If you are removing the configuration node, the **rmnode** command causes the configuration node to move to a different node within the clustered system. This process might take a short time, typically less than a minute. The clustered system IP address remains unchanged, but any SSH client attached to the configuration node might must reestablish a connection.
  - b. If you turn on the power to the node that has been removed and it is still connected to the same fabric or zone, it attempts to rejoin the clustered system. The clustered system causes the node to remove itself from the clustered system and the node becomes a candidate for addition to this clustered system or another clustered system.
  - c. If you are adding this node into the clustered system, ensure that you add it to the same I/O group that it was previously a member of. Failure to do so can result in data corruption.
  - d. In a service situation, a node should normally be added back into a clustered system using the original node name. As long as the partner node in the I/O group has not been deleted too, this is the default name used if **-name** is not specified.
3. Before you delete the node, update the multipathing device driver configuration on the host to remove all device identifiers that are presented by the volumes that you intend to remove. If you are using the subsystem device driver, the device identifiers are referred to as virtual paths (vpaths).

**Attention:** Failure to perform this step can result in data corruption.

See the *IBM System Storage Multipath Subsystem Device Driver User's Guide* for details about how to dynamically reconfigure SDD for the given host operating system.

4. Issue the following CLI command to delete a node from the clustered system:

**Attention:** Before you delete the node: The **rmnode** command checks for node-dependent volumes, which are not mirrored at the time that the command is run. If any node-dependent volumes are found, the command stops and returns a message. To continue removing the node despite the potential loss of data, run the **rmnode** command with the **force** parameter. Alternatively, follow these steps before you remove the node to ensure that all volumes are mirrored:

- a. Run the **lsindependentvdisks** command.
- b. For each node-dependent volume that is returned, run the **lsvdisk** command.
- c. Ensure that each volume returns in-sync status.

```
rmnode node_name_or_id
```

Where *node\_name\_or\_id* is the name or ID of the node.

---

## Performing the clustered system maintenance procedure using the CLI

You can use the command-line interface (CLI) to perform the clustered system maintenance procedure.

Perform the following steps for clustered system maintenance:

1. Issue the **finderr** command to analyze the error log for the highest severity of unfixed errors. This command scans the error log for any unfixed errors. Given a priority ordering defined within the code, the highest priority of unfixed errors is returned.
2. Issue the **dumperrlog** command to dump the contents of the error log to a text file.
3. Locate and fix the error.
4. Issue the **clearerrlog** command to clear all entries from the error log, including status events and any unfixed errors. Only issue this command when you have either rebuilt the clustered system or have fixed a major problem that has caused many entries in the error log that you do not want to fix individually.

**Note:** Clearing the error log does not fix the errors.

5. Issue the **cherrstate** command to toggle the state of an error between unfixed and fixed.

---

## Modifying the cluster (system) IP addresses using the CLI

You can use the command-line interface (CLI) to change the IP addresses that are associated with a clustered system.

**Attention:** When you specify a new IP address for a clustered system, the existing communication with the system is broken. You must reconnect to the system with the new IP address.

Perform the following steps to change the system IP address:

1. Issue the **lsclusterip** command to list the current IP addresses that are used by the system.
2. Record the current IP addresses for future reference.
3. To change an IPv4 system IP address, issue the following command:  

```
chclusterip -clusterip cluster_ip_address -port cluster_port
```

where *cluster\_ip\_address* is the new IP address for the system and *cluster\_port* specifies which port (1 or 2) to apply changes to.
4. To change an IPv4 system IP address to an IPv6 system IP address, issue the following command:  

```
chclusterip -clusterip_6 cluster_ip_address -port cluster_port
```

where *cluster\_ip\_address* is the new IPv6 address for the system and *cluster\_port* specifies which port (1 or 2) to apply changes to.
5. To change an IPv4 default gateway IP address, issue the following command:  

```
chclusterip -gw cluster_gateway_address -port cluster_port
```

where *cluster\_gateway\_address* is the new gateway address for the system and *cluster\_port* specifies which port (1 or 2) to apply changes to.
6. To change an IPv6 default gateway address, issue the following command:  

```
chclusterip -gw_6 cluster_gateway_address -port cluster_port
```

where *cluster\_gateway\_address* is the new gateway address for the system and *cluster\_port* specifies which port (1 or 2) to apply changes to.
7. Issue the following command to change an IPv4 system subnet mask:  

```
chclusterip -mask cluster_subnet_mask -port cluster_port
```

where *cluster\_subnet\_mask* is the new subnet mask for the system and *cluster\_port* specifies which port (1 or 2) to apply changes to.
8. For IPv6 addresses, you can issue the following command to set the prefix for the system:  

```
chclusterip -prefix_6 -port cluster_port
```

where *cluster\_port* specifies which port (1 or 2) to apply changes to.
9. Optionally, if you want to delete all of the IPv4 addresses in the system after you have changed all addresses to IPv6, issue the following command:  

```
chcluster -noip
```
10. Optionally, if you want to delete all of the IPv6 addresses in the system after you have changed all addresses to IPv4, issue the following command:  

```
chcluster -noip_6
```
11. The IP routing table provides details of the gateway that is used for IP traffic to a range of IP addresses for each Ethernet port. This information can be used to diagnose configuration node accessibility problems. To display the IP routing table, enter the following CLI command:  

```
lsroute
```
12. The ping command can be used to diagnose IP configuration problems by checking whether a given IP address is accessible from the configuration node. The command can be useful for diagnosing problems where the configuration node cannot be reached from a specific management server. For example, enter the following CLI command:  

```
ping ipv4_address | ipv6_address
```

where *ipv4\_address* | *ipv6\_address* is either the IPv4 address or the IPv6 address.

---

## Changing the clustered system gateway address using the CLI

You can use the command-line interface (CLI) to change the gateway address for a clustered system.

Perform the following steps to change the clustered system gateway address:

1. Issue the **lsclusterip** command to list the current gateway address of the clustered system.
2. Record the current gateway address for future reference.
3. Issue the following command to change an IPv4 clustered system gateway address:

```
chclusterip -gw cluster_gateway_address -port cluster_port
```

where *cluster\_gateway\_address* is the new gateway address for the clustered system. The **port** parameter specifies which port (1 or 2) to apply changes to.

4. Issue the following command to change an IPv6 clustered system gateway address:

```
chclusterip -gw_6 cluster_gateway_address -port cluster_port
```

where *cluster\_gateway\_address* is the new gateway address for the clustered system. The **port** parameter specifies which port (1 or 2) to apply changes to.

---

## Changing the relationship bandwidth for a clustered system using the CLI

You can use the command-line interface (CLI) to change the relationship bandwidth for a clustered system.

The relationship bandwidth limit controls the maximum rate at which any one remote-copy relationship can synchronize. The overall limit is controlled by the **bandwidth** parameter of each clustered system partnership. The default value for the relationship bandwidth limit is 25 megabytes per second (MBps), but you can change this by following these steps:

1. Issue the **lscluster** command to list the current relationship bandwidth limit of the cluster. For example:

```
lscluster cluster_id_or_cluster_name
```

Where *cluster\_id\_or\_cluster\_name* is the ID or name of the clustered system.

2. For future reference, record the current relationship bandwidth limit that is displayed. For example:  

```
relationship_bandwidth_limit 25
```
3. To change the relationship bandwidth limit of the clustered system, issue the following command:

```
chcluster -relationshipbandwidthlimit
cluster_relationship_bandwidth_limit
```

Where *cluster\_relationship\_bandwidth\_limit* is the new limit for the cluster. Issue the command on both clusters in a relationship.

---

## Configuring the clustered system for iSCSI using the CLI

You need to complete several tasks to configure the clustered system to work with iSCSI-attached hosts. The tasks include general tasks on the host system before you configure a clustered system on the SAN Volume Controller.

Before completing any iSCSI-configuration tasks on the system, it is important that you complete all the iSCSI-related configuration on the host machine. Because the SAN Volume Controller supports a variety of host machines, consult the documentation for specific instructions and requirements for a particular host. For a list of supported hosts, see this website:

Support for SAN Volume Controller (2145) website at [www.ibm.com/storage/support/2145](http://www.ibm.com/storage/support/2145)

To configure a system for iSCSI, follow these general tasks on the host system:

1. Select a software-based iSCSI initiator, such as Microsoft Windows iSCSI Software Initiator and verify the iSCSI driver installation.
2. If required, install and configure a multipathing driver for the host system.

In addition, determine a naming convention for iSCSI names, such as iSCSI qualified names (IQNs) for your system. Hosts use iSCSI names to connect to the node. Each node, for example, has a unique IQN, and the system name and node name are used as part of that IQN. Each node, for example, has a unique IQN, and the system name and node name are used as part of that IQN.

Port IP addresses are the IP addresses that are used by iSCSI-attached hosts to perform I/O.

1. To configure a new port IP address to a specified Ethernet port of a node with an IPv4 address, enter the following command-line interface (CLI) command:

```
cfgportip -node node_name | node_id -ip ipv4addr
-gw ipv4gw -mask subnet_mask -failover port_id
```

where *node\_name* | *node\_id* specifies the name or ID of the node that is being configured, *ipv4addr* is the IPv4 address for the Ethernet port, *ipv4gw* is the IPv4 gateway IP address, *subnet\_mask* is the IPv4 subnet mask, and *port\_id* specifies the Ethernet port ID (1 or 2). To view a list of ports, use the **lspportip** command.

The optional **-failover** parameter specifies that the port is to be used during failover. If the node that is specified is the only online node in the I/O group, the address is configured and presented by this node. When another node in the I/O group comes online, the failover address is presented by that node. If two nodes in the I/O group are online when the command is issued, the address is presented by the other node to the partner node.

2. To configure a new port IP address that belongs to a partner node with an IPv6 address in the I/O group, enter the following CLI command:

```
cfgportip -node node_name | node_id -ip_6 ipv6addr
-gw_6 ipv6gw -prefix_6 prefix -failover port_id
```

where *node\_name* | *node\_id* specifies the name or ID of the node that is being configured, *ipv6addr* is the IPv6 address for the iSCSI port, *ipv6gw* is the gateway address for the given IP address, *prefix* is the IPv6 prefix for the gateway, and *port\_id* specifies the Ethernet port ID (1 or 2). To view a list of ports, use the **lspportip** command. If the partner node is offline, the address is configured and presented by this node. When a partner node comes online, the failover address is presented by that node.

The optional **-failover** parameter specifies that the data is failover data, which is data that is related to the partner node. If the node that is specified is the only online node in the I/O group, the address is configured and presented by this node. When another node in the I/O group comes online, the failover address is presented by that node. If two nodes in the I/O group are online when the command is issued, the address is presented by the other node to that specified.

3. To remove an iSCSI IP address from a node Ethernet port, enter either of these CLI commands. The following command deletes an IPv4 configuration for the specified iSCSI Ethernet port:

```
rmportip -failover
-node node_name | node_id port_id
```

where *node\_name* | *node\_id* specifies the name or ID of the node with the Ethernet port that the IP address is being removed from and *port\_id* specifies the Ethernet port ID. To list the valid values for the Ethernet port, enter the **lspportip** command. The optional **-failover** parameter indicates that the specified data is failover data.

The following command deletes an IPv6 configuration for the specified iSCSI Ethernet port:

```
rmportip -ip_6 -failover
-node node_name | node_id port_id
```

where **-ip\_6** indicates that this command will remove an IPv6 configuration, *node\_name* | *node\_id* specifies the name or ID of the node with the Ethernet port that the IP address is being removed from, and *port\_id* specifies the Ethernet port ID. To list the valid values for the Ethernet port, enter the **!sportip** command. The optional **-failover** parameter indicates that the specified data is failover data.

After you configure your IP addresses, you can optionally create iSCSI aliases.

## Configuring or modifying an iSCSI alias using the CLI

You can use the command-line interface (CLI) to optionally create or change the iSCSI alias for the selected node. An iSCSI alias is a user-assigned name that identifies the SAN Volume Controller node to the iSCSI-attached host.

To configure or modify an iSCSI alias, follow these steps:

1. To configure a new port IP address to a specified Ethernet port of a node, enter the following CLI command:

```
chnode -iscsialias alias node_name | node_id
```

where *alias node\_name* | *node\_id* specifies the name or ID of the node.

2. To specify that the name or iSCSI alias that is being set is the name or alias of the partner node in the I/O group, enter the following CLI command. When there is no partner node, the values set are applied to the partner node when it is added to the clustered system. If this parameter is used when there is a partner node, the name or alias of that node changes

```
chnode -iscsialias alias -failover node_name | node_id
```

where *alias* specifies the iSCSI name of the node and *node\_name* | *node\_id* specifies the node to be modified.

- | After you create iSCSI aliases, you can optionally configure the address for the Internet Storage Name Service (iSNS) server for the system.

## Configuring the iSNS server address using the CLI

- | If you are using iSCSI-attached hosts with the SAN Volume Controller clustered system, you can use the command-line interface (CLI) to optionally configure the address for the Internet Storage Name Service (iSNS) server for the system. Host systems use the iSNS server to manage iSCSI targets and for iSCSI discovery.

1. To specify an IPv4 address for the iSCSI storage name service (SNS), enter the following CLI command:

```
chcluster -isnsip sns_server_address
```

where *sns\_server\_address* is the IP address of the iSCSI storage name service in IPv4 format.

2. To specify an IPv6 address for the iSCSI storage name service (SNS), enter the following CLI command:

```
chcluster -isnsip_6 ipv6_sns_server_address
```

where *ipv6\_sns\_server\_address* is the IP address of the iSCSI storage name service in IPv6 format.

- | After you configure the iSNS server address for the system, you can configure system iSCSI authentication.

**Note:** To help in problem determination, this step can be delayed until after the first one or two hosts have been configured and their connectivity has been tested without authentication configured.

## Configuring clustered system iSCSI authentication using the CLI

You can use the command-line interface (CLI) to configure the Challenge-Handshake Authentication Protocol (CHAP) to authenticate the SAN Volume Controller clustered system to the iSCSI-attached hosts. After the CHAP is set for the clustered system, all attached hosts must be configured to authenticate this way. To help in problem determination, this step can be delayed until after the first one or two hosts have been configured and their connectivity has been tested without authentication configured.

To configure authentication between the SAN Volume Controller clustered system and the iSCSI-attached hosts, follow these steps:

1. To set the authentication method for the iSCSI communications of the clustered system, enter the following CLI command:

```
chcluster -iscsiauthmethod chap -chapsecret chap_secret
```

where *chap* sets the authentication method for the iSCSI communications of the clustered system and *chap\_secret* sets the CHAP secret to be used to authenticate the clustered system via iSCSI. This parameter is required if the **iscsiauthmethod chap** parameter is specified. The specified CHAP secret cannot begin or end with a space.

2. To clear any previously set CHAP secret for iSCSI authentication, enter the following CLI command:

```
chcluster -nochapsecret
```

The **nochapsecret** parameter is not allowed if the **chapsecret** parameter is specified.

3. The **lscsiauth** command lists the Challenge Handshake Authentication Protocol (CHAP) secret that is configured for authenticating an entity to the SAN Volume Controller clustered system. The command also displays the configured iSCSI authentication method. For example, enter the following CLI command:

```
lscsiauth
```

After you configure the CHAP secret for the SAN Volume Controller clustered system, ensure that the clustered system CHAP secret is added to each iSCSI-attached host. On all iSCSI-attached hosts, specify a CHAP secret that the hosts use to authenticate to the SAN Volume Controller clustered system.

---

## Configuring remote authentication service using CLI

You can use the command-line interface (CLI) to configure the SAN Volume Controller to use remote authentication.

- | Remote authentication allows users of SAN management applications, such as IBM Tivoli Storage Productivity Center, to authenticate to the clustered system using the authentication service provided by the SAN management application. To use the SAN Volume Controller with a remote authentication service, follow these steps:

- | 1. Configure the system with the location of the remote authentication server.

To change settings, issue the **chauthservice** command. To view settings, issue the **lsccluster** command.

You can use either an http or https connection to the server. If you use an http option, the user and password information is transmitted in clear text over the IP network.

- | 2. Configure user groups on the system by matching those that are used by the authentication service.

For each group of interest known to the authentication service, a SAN Volume Controller user group must be created with the same name and with the remote setting enabled. If, for example, members of a group called *sysadmins* require the SAN Volume Controller Administrator (admin) role, issue the following command:

```
mkusergrp -name sysadmins -remote -role Administrator
```



- If none of the groups for a user match any of the SAN Volume Controller user groups, the user is not permitted to access the system.
- Configure users who do not require Secure Shell (SSH) access.  
SAN Volume Controller users who are to use the remote authentication service and do not require SSH access should be deleted from the system. The superuser cannot be deleted and cannot use the remote authentication service.
  - Configure users who require SSH access.  
All SAN Volume Controller users who are to use the remote authentication service and require SSH access must have their remote settings enabled and the same password set both on the system and on the authentication service.  
The remote setting instructs SAN Volume Controller to check the authentication service for group information for determining the role of the user.
  - Configure the system time.  
The current time of both the SAN Volume Controller clustered system and the system that is running the remote authentication service must match. The easiest way to do this is to use the same Network Time Protocol (NTP) server for both.  
**Attention:** Failure to follow this step could result in either poor interactive performance of the SAN Volume Controller user interface or in incorrect user-role assignments.

---

## Creating and working with user groups using the CLI

- You can use the command-line interface (CLI) to create and work with users and user groups. User groups organize users of a clustered system by role.
- Roles apply to both local and remote users on the system and are based on the user group to which the user belongs. A local user can only belong to a single group; therefore, the role of a local user is defined by the single group that the user belongs to. Remote users can belong to one or more groups; therefore, the roles of remote users are assigned according to the groups that the remote user belongs to.

To create and work with user groups, follow these steps:

- Issue the **mkusergrp** CLI command to create a new user group. For example:

```
mkusergrp -name group_name -role role_name -remote
```

where *group\_name* specifies the name of the user group and *role\_name* specifies the role that is associated with any users that belong to this group. The **remote** parameter specifies that the group is visible to the remote authentication service.

The command returns the ID of the user group that was created. To create user groups in the management GUI, select **User Management > Users**. From the **Global Actions** menu, select **New User Group**.

- Issue the **chusergrp** CLI command to change attributes of an existing user group. For example:

```
chusergrp -role role_name -remote yes | no group_id_or_name
```

where *role\_name* specifies the role that is associated with any users that belong to this group and *group\_id\_or\_name* specifies the group to be changed. The **remote** parameter specifies whether the group is visible to the authentication server.

To change a user group in the management GUI, select **User Management > Users**. Select a user group and select **Properties** from the **Actions** menu.

- Issue the **rmusergrp** CLI command to delete a user group: For example:

```
rmusergrp -force group_id_or_name
```

where *group\_id\_or\_name* specifies the group to delete. The **force** parameter specifies to delete the group even if there are users in the user group. All users that were assigned to this group are assigned to the Monitor group.

To delete a user group in the management GUI, select **User Management > Users**. Select a user group and select **Delete** from the **Actions** menu.

4. Issue the **lsusergrp** CLI command to display the user groups that have been created on the system. For example:

```
lsusergrp usergrp_id_or_name
```

- where *group\_id\_or\_name* specifies the user group to view. If you do not specify a user group ID or name, all user groups on the system are displayed.

---

## Creating and working with users using the CLI

You can use the command-line interface (CLI) to create and work with users.

- You can create two categories of users that access the clustered system. These types are based on how the users are authenticated to the system. Local users must provide either a password, a Secure Shell (SSH) key, or both. Local users are authenticated through the authentication methods that are located on the SAN Volume Controller system. If the local user needs access to the management GUI, a password is needed for the user. If the user requires access to the command-line interface (CLI), a valid SSH key file is necessary. If a user is working with both interfaces, both a password and SSH key are required. Local users must be part of a user group that is defined on the system. User groups define roles that authorize the users within that group to a specific set of operations on the system.

A remote user is authenticated on a remote service that is usually provided by a SAN management application, such as IBM Tivoli Storage Productivity Center, and does not need local authentication methods. For a remote user, both a password and SSH key are required to use the command-line interface. Remote users only need local credentials to access to the management GUI if the remote service is down. Remote users have their groups defined by the remote authentication service.

To create and work with users, follow these steps:

1. Issue the **mkuser** CLI command to create either a local user or a remote user to access the SAN Volume Controller. For example:

```
mkuser -name user_name -remote
```

where *user\_name* specifies the name of the user. The **remote** parameter specifies that the user authenticates to the remote authentication service.

```
mkuser -name user_name -usergrp group_name_or_id
```

- where *user\_name* specifies the name of the user and *group\_name\_or\_id* specifies the name or ID of the user group with which the local user is to be associated. The **usergrp** parameter specifies that the user authenticates to the system by using system authentication methods.

2. Issue the **chuser** CLI command to change the attributes of an existing user. For example:

```
chuser -usergrp group_id_or_name user_id_or_name
```

where the *group\_id\_or\_name* specifies the new group for the user and *user\_id\_or\_name* specifies the user to be changed.

3. Issue the **chcurrentuser** CLI command to change the attributes of the current user. For example:

```
chcurrentuser -nokey
```

where the **nokey** parameter specifies that the SSH key of the user is to be deleted.

4. Issue the **rmuser** CLI command to delete a user: For example:

```
rmuser user_id_or_name
```

where *user\_id\_or\_name* specifies the user to be removed.

5. Issue the **lsuser** CLI command to display a list of users that have been created on the system. For example:

```
lsuser user_id_or_name
```

where *user\_id\_or\_name* specifies the ID or name of the user view. If you do not specify an ID or name, the concise view is displayed. If you do not specify a user ID or name, all users on the system are displayed.

6. Issue the **lscurrentuser** CLI command to display the name and role of the logged-in user. For example:

```
lscurrentuser
```

The name and the role of the user are displayed.

---

## Setting up SNMP notifications using the CLI

You can set up event notifications using the command-line interface (CLI).

The notification settings apply to the entire cluster. You can specify the types of events that cause the cluster to send a notification. The cluster sends a Simple Network Management Protocol (SNMP) notification. The SNMP setting represents the type of notification.

SNMP is the standard protocol for managing networks and exchanging messages. SNMP enables the SAN Volume Controller to send external messages that notify personnel about an event. You can use an SNMP manager to view the messages that the SNMP agent sends.

The possible types of event notifications are error, warning, and information. Event notifications are reported to the SNMP destinations of your choice. To specify an SNMP destination, you *must* provide a valid IP address and SNMP community string.

**Note:** A valid community string can contain up to 60 letters or digits (most characters). A maximum of six SNMP destinations can be specified.

In configurations that use SNMP, the SAN Volume Controller uses the notifications settings to call home if errors occur. You must specify Error and send the trap to the IBM System Storage Productivity Center or the master console if you want the SAN Volume Controller to call home when errors occur.

To configure the SNMP notification settings, use the following commands:

1. To create a new SNMP server to receive notifications, use the **mksnmpserver** CLI command. For example, enter one of the following commands:

```
mksnmpserver -ip 9.11.255.634
```

where *9.11.255.634* is the IP addresses for this server.

```
mksnmpserver -ip 9.11.255.634 -port remoteportnumber
```

where *9.11.255.634* is the IP addresses for this server and *remoteportnumber* is the port number for the remote SNMP server.

2. To change the settings of an existing SNMP server, enter the **chsnmpserver** command. For example:

```
chsnmpserver -name newserver snmp_server_name_or_id
```

where *newserver* is the new name or ID of the server and *snmp\_server\_name\_or\_id* is the name or ID of the server to be modified.

3. To remove an existing SNMP server from the system, enter the **rmsnmpserver** command. For example:

```
rmsnmpserver snmp_server_name_or_id
```

where *snmp\_server\_name\_or\_id* is either the name or the ID of the SNMP server to be deleted.

4. To display either a concise list or a detailed view of the SNMP servers that are detected by the cluster, enter the **lssnmpserver** command. For example, to display a concise view, enter the following command:

```
lssnmpserver -delim :
```

To display a detailed view of an SNMP server, enter the following command:

```
lssnmpserver snmp_server_name_or_id
```

---

## Setting up syslog notifications using the CLI

You can set up syslog event notifications using the command-line interface (CLI).

The syslog protocol is a standard protocol for forwarding log messages from a sender to a receiver on an IP network. The IP network can be either IPv4 or IPv6. The system can send syslog messages that notify personnel about an event. The system can transmit syslog messages in either expanded or concise format. You can use a syslog manager to view the syslog messages that the system sends. The system uses the User Datagram Protocol (UDP) to transmit the syslog message. You can use the management GUI or the SAN Volume Controller command-line interface to configure and modify your syslog settings.

The syslog event notification settings apply to the entire cluster. You can specify the types of events that cause the cluster to send a notification. The possible types of notifications are error, warning, or information.

To specify a syslog destination, you *must* provide a valid IP address.

**Note:** Servers that are configured with facility values of 0 - 3 receive syslog messages in concise format. Servers that are configured with facility values of 4 - 7 receive syslog messages in fully expanded format.

The SAN Volume Controller uses the notifications settings to call home if errors occur.

To configure and work with notification settings, use the following commands:

1. Issue the **mksyslogserver** CLI command to specify the action that you want to take when a syslog error or event is logged to the error log. For example, you can issue the following CLI command to set up a syslog notification:

```
mksyslogserver -ip 9.11.255.634
```

where *9.11.255.634* is the IP address of the syslog server.

2. To modify a syslog notification, issue the **chsyslogserver** command. For example:

```
chsyslogserver -name -facility facility_number syslog_server_name_or_id
```

where *facility number* is a facility number to identify the origin of the message to the receiving server and *syslog\_server\_name\_or\_id* is the name or ID of the server to be modified.

3. To delete a syslog notification, issue the **rmsyslogserver** command. For example:

```
rmsyslogserver syslog_server_name_or_id
```

4. To display either a concise list or a detailed view of syslog servers that are configured on the cluster, issue the **lssyslogserver** command. For example, to display a concise view, enter the following command:

```
lssyslogserver -delim :
```

To display a detailed view of a syslog server, enter the following command:

```
lssyslogserver snmp_server_name_or_id
```

---

## Setting up email event notifications and inventory reports using the CLI

You can use the command-line interface (CLI) to set up your system to send event notification and inventory reports to specified recipients and the IBM Support Center

To set up, manage, and activate email event and inventory notifications, complete the following steps:

1. Enable your system to use the email notification function. To do this, issue the **mkemailserver** CLI command. Up to six SMTP email servers can be configured to provide redundant access to the external email network.

The following example creates an email server object. It specifies the name, IP address, and port number of the SMTP email server. After you issue the command, you see a message that indicates that the email server was successfully created.

```
mkemailserver -ip ip_address -port port_number
```

where *ip\_address* specifies the IP address of a remote email server and *port\_number* specifies the port number for the email server.

2. Add recipients of email event and inventory notifications to the email event notification facility. To do this, issue the **mkemailuser** CLI command. You can add up to twelve recipients, one recipient at a time.

The following example adds email recipient **manager2008** and designates that **manager2008** receive email error-type event notifications.

```
mkemailuser -address manager2008@ibm.com
-error on -usertype local
```

3. Set the contact information that is used by the email event notification facility. To do this, issue the **chemail** CLI command. If you are starting the email event notification facility, the **reply**, **contact**, **primary**, and **location** parameters are required. If you are modifying contact information used by the email event notification facility, at least one of the parameters must be specified.

The following example sets the contact information for the email recipient **manager2008**.

```
chemail -reply manager2008@ibm.com -contact manager2008
-primary 0441234567 -location 'room 256 floor 1 IBM'
```

4. Optionally, generate a report that lists email event notification settings for all email recipients, or change or delete email recipients.
  - To generate a report that lists the email event notification settings for all email recipients, an individual email recipient, or a specified type of email recipient (local or support), issue the **lsemailuser** CLI command.
  - To change the settings that are defined for a recipient, issue the **chemailuser** CLI command. You must specify the user ID or name of the email recipient for whom you are modifying settings.
  - To remove a previously defined email recipient, issue the **rmemailuser** CLI command. You must specify the user ID or name of the email recipient that you want to remove.
5. Activate the email and inventory notification function. To do this, issue the **startemail** CLI command. There are no parameters for this command.

**Note:** Inventory information is automatically reported to IBM when you activate error reporting.

6. Optionally, test the email notification function to ensure that it is operating correctly and send an inventory email notification.
  - To send a test email notification to one or more recipients, issue the **testemail** CLI command. You must either specify **all** or the user ID or user name of an email recipient that you want to send a test email to.
  - To send an inventory email notification to all recipients that are enabled to receive inventory email notifications, issue the **sendinventoryemail** CLI command. There are no parameters for this command.

---

## Setting up email servers using the CLI

You can set up email server objects using the command-line interface (CLI).

You can specify a server object that describes a remote Simple Mail Transfer Protocol (SMTP) email server to receive event notifications from the clustered system. You can specify up to six servers to receive notifications. To configure and work with email servers, use the following commands:

1. Issue the **mkemailserver** CLI command to create an email server object that describes a remote Simple Mail Transfer Protocol (SMTP) email server. For example, issue the following CLI command to set up an email server:

```
mkemailserver -ip ip_address
```

where *ip\_address* is the IP address of a remote email server. This must be a valid IPv4 or IPv6 address.

2. To change the parameters of an existing email server object, issue the **chemailserver** command. For example:

```
chemailserver -ip ip_address email_server_name_or_id
```

where *ip\_address* is the IP address of the email server object and *email\_server\_name\_or\_id* is the name or ID of the server object to be changed.

3. To delete a specified email server object, issue the **rmemailserver** command. For example:

```
rmemailserver email_server_name_or_id
```

To display either a concise list or a detailed view of email servers that are configured on the system, issue the **lsemailserver** command. For example, to display a concise view, enter the following command:

```
lsemailserver -delim :
```

To display a detailed view of an email server, enter the following command:

```
lsemailserver email_server_name_or_id
```

---

## Changing clustered system passwords using the CLI

You can use the command-line interface (CLI) to change the superuser and service passwords.

Passwords only affect the management GUI that accesses the clustered system. To restrict access to the CLI, you must control the list of SSH client keys that are installed on the clustered system.

Perform the following steps to change the superuser and service passwords:

1. Issue the following command to change the superuser password:

```
chuser -password superuser_password superuser
```

Where *superuser\_password* is the new superuser password that you want to use.

2. Issue the following command to change the service password:

```
chcluster -servicepwd service_password
```

Where *service\_password* is the new service password that you want to use.

---

## Changing the locale setting using the CLI

You can use the command-line interface (CLI) to specify the locale for a SAN Volume Controller cluster. The language that you select as your locale setting is used to display command results and error messages in the CLI.

The following locales are available:

- 0 US English (default)
- 3 Japanese

Issue the **setlocale** CLI command with the ID for the locale.

For example, issue the following CLI command to change the locale setting from US English to Japanese:

```
setlocale 3
```

where 3 is the ID for the Japanese locale setting.

---

## Viewing the feature log using the CLI

You can use the command-line interface (CLI) to view the feature log.

Perform the following steps to view the feature log:

1. Issue the **svcinfo lsfeaturedumps** command to return a list of dumps in the `/dumps/feature` destination directory. The feature log is maintained by the cluster. The feature log records events that are generated when license parameters are entered or when the current license settings have been breached.
2. Issue the **svcservicemodeinfo lsfeaturedumps** command to return a list of the files that exist of the type specified on the given node.

---

## Analyzing the error log using the CLI

You can use the command-line interface (CLI) to analyze the error log (event log).

Perform the following step to analyze the error log:

Issue the following CLI command to list error log entries by file type: **lseventlog**

This command lists the error log entries. You can filter by type; for example, `lseventlog -filtervalue object_type=mdisk` displays the error log by managed disks (MDisks).

You can display the whole log or filter the log so that only errors, events, or unfixed errors are displayed. You can also request that the output is sorted either by error priority or by time. For error priority, the most serious errors are the lowest-numbered errors. Therefore, the most serious errors are displayed first in the table. For time, either the older or the latest entry can be displayed first in the output.

---

## Shutting down a clustered system using the CLI

You can use the command-line interface (CLI) to shut down a clustered system.

- | If you want to remove all input power to a clustered system (for example, the machine room power must be shutdown for maintenance), you must shut down the system before the power is removed. If you do not shut down the system before turning off input power to the uninterruptible power supply, the SAN Volume Controller nodes detect the loss of power and continue to run on battery power until all data that is held in memory is saved to the internal disk drive. This increases the time that is required to make the system operational when input power is restored and severely increases the time that is required to recover from an unexpected loss of power that might occur before the uninterruptible power supply batteries have fully recharged.

When input power is restored to the uninterruptible power supply units, they start to recharge. However, the SAN Volume Controller nodes do not permit any I/O activity to be performed to the VDIs (volumes) until the uninterruptible power supply is charged enough to enable all the data on the SAN Volume Controller nodes to be saved in the event of an unexpected power loss. This might take as long

as two hours. Shutting down the system prior to removing input power to the uninterruptible power supply units prevents the battery power from being drained and makes it possible for I/O activity to resume as soon as input power is restored.

Before shutting down a system, quiesce all I/O operations that are destined for the system. Failure to do so can result in failed I/O operations being reported to your host operating systems.

**Attention:** If you are shutting down the entire system, you lose access to all volumes that are provided by this system. Shutting down the system also shuts down all SAN Volume Controller nodes. This shutdown causes the hardened data to be dumped to the internal hard drive.

Begin the following process of quiescing all I/O to the system by stopping the applications on your hosts that are using the volumes that are provided by the system.

1. Determine which hosts are using the volumes that are provided by the system.
2. Repeat the previous step for all volumes.

If input power is lost and subsequently restored, you must press the power button on the uninterruptible power supply units before you press the power buttons on the SAN Volume Controller nodes.

Perform the following steps to shut down a system:

1. Issue the following command to shut down a clustered system:

```
stopcluster
```

The following output is displayed:

```
Are you sure that you want to continue with the shut down?
```

2. Type `y` to shut down the entire clustered system.

---

## Upgrading the software automatically using the CLI

You can use the command-line interface (CLI) to install software upgrades.

This procedure is for upgrading from SAN Volume Controller version 6.1.0 or later. To upgrade from version 5.1.x or earlier, see the relevant information center or publications that are available at this website:

Support for SAN Volume Controller (2145) website at [www.ibm.com/storage/support/2145](http://www.ibm.com/storage/support/2145)

**Attention:** Before you start a software upgrade, you must check for offline or degraded volumes. An offline volume can cause write data that has been modified to be pinned in the SAN Volume Controller cache. This prevents volume failover and causes a loss of I/O access during the software upgrade. If the `fast_write_state` is empty, a volume can be offline and not cause errors during the software upgrade.

Perform the following steps to upgrade the software:

1. Download, install, and run the latest version of the Software Upgrade Test Utility to verify that there are no issues with the current clustered system environment. You can download the most current version of this tool at the following website:  
<http://www.ibm.com/support/docview.wss?uid=ssg1S4000585>
2. Download the SAN Volume Controller code from the Support for SAN Volume Controller (2145) website at [www.ibm.com/storage/support/2145](http://www.ibm.com/storage/support/2145).
  - If you want to write the SAN Volume Controller code to a CD, you must download the CD image.
  - If you do not want to write the SAN Volume Controller code to a CD, you must download the installation image.



3. Use PuTTY scp (pscp) to copy the software upgrade files to the node.
4. Ensure that the software upgrade file has been successfully copied.

Before you begin the software upgrade, you must be aware of the following:

- The installation process fails under the following conditions:

- If the software that is installed on the remote system is not compatible with the new software or if there is an intersystem communication error that does not allow the software to check that the software is compatible.
- If any node in the system has a hardware type that is not supported by the new software.
- If the SAN Volume Controller software determines that one or more volumes in the system would be taken offline by rebooting the nodes as part of the upgrade process. You can find details about which volumes would be affected by using the **lsdependentdisks** command. If you are prepared to lose access to data during the upgrade, you can use the force flag to override this restriction.

- The software upgrade is distributed to all the nodes in the system by using Fibre Channel connections between the nodes.

- Nodes are updated one at a time.

- Nodes will run the new software concurrently with normal system activity.

- While the node is updated, it does not participate in I/O activity in the I/O group. As a result, all I/O activity for the volumes in the I/O group is directed to the other node in the I/O group by the host multipathing software.

- There is a 30-minute delay between node updates. The delay allows time for the host multipathing software to rediscover paths to the nodes which have been upgraded, so that there is no loss of access when another node in the I/O group is updated.

- The software update is not committed until all nodes in the system have been successfully updated to the new software level. If all nodes successfully restart with the new software level, the new level is committed. When the new level is committed, the system vital product data (VPD) is updated to reflect the new software level.

- You cannot invoke the new functions of the upgraded software until all member nodes are upgraded and the update has been committed.

- Because the software upgrade process takes some time, the installation command completes as soon as the software level is verified by the system. To determine when the upgrade has completed, you must either display the software level in the system VPD or look for the Software upgrade complete event in the error/event log. If any node fails to restart with the new software level or fails at any other time during the process, the software level is backed off.

- During a software upgrade, the version number of each node is updated when the software has been installed and the node has been restarted. The system software version number is updated when the new software level is committed.

- When the software upgrade starts an entry is made in the error or event log and another entry is made when the upgrade completes or fails.

5. Issue the following CLI command to start the software upgrade process:

```
applysoftware -file software_upgrade_file
```

where *software\_upgrade\_file* is the name of the software upgrade file. If the system identifies any volumes that would go offline as a result of rebooting the nodes as part of the system upgrade, the software upgrade does not start. An optional **force** parameter can be used to indicate that the upgrade continue in spite of the problem identified. Use the **lsdependentdisks** command to identify the cause for the failed upgrade. If you use the **force** parameter, you are prompted to confirm that you want to continue. The behavior of the **force** parameter has changed, and it is no longer required when applying an upgrade to a system with errors in the event log.

6. Issue the following CLI command to check the status of the software upgrade process:

```
lssoftwareupgradestatus
```

**Note:** If a status of `stalled_non_redundant` is displayed, proceeding with the remaining set of node upgrades might result in offline volumes. Contact an IBM service representative to complete the upgrade.

7. Perform the following steps to verify that the software upgrade successfully completed:

a. Issue the **`dumperrlog`** CLI command to send the contents of the event log to a text file.

If the software is successfully upgraded, the following output is displayed in the text file:

```
Upgrade completed successfully
```

b. Issue the **`lsnodevpd`** CLI command for each node that is in the system. The software version field displays the new software level.

When a new software level is applied, it is automatically installed on all the nodes that are in the system.

**Note:** The software upgrade can take up to 30 minutes per node.

---

## Chapter 4. Overview of the dumps commands

The **lsdumps** command returns a list of dumps in a particular directory.

Dumps are contained in the following directory structure:

- /dumps
- /dumps/audit
- /dumps/cimom
- /dumps/elogs
- /dumps/feature
- /dumps/iostats
- /dumps/iotrace
- /dumps/mdisk
- /home/admin/upgrade
- /dumps/drive
- /dumps/enclosure

Use the **lsdumps** command with the optional **prefix** parameter to specify a directory. If you do not specify a directory, /dumps is used as the default. Use the optional *node\_id\_or\_name* parameter to specify the node to list the available dumps for. If you do not specify a node, the available dumps on the configuration node are listed.

An audit log keeps track of action commands that are issued through an SSH session or from the management GUI. To list a specified number of the most recently audited commands, issue the **catauditlog** command. To dump the contents of the audit log to a file on the current configuration node, issue the **dumpauditlog** command. This command also clears the contents of the audit log.

Dumps contained in the /dumps/cimom directory are created by the CIMOM (Common Information Model Object Manager) that runs on the cluster. These files are produced during normal operations of the CIMOM.

Dumps that are contained in the /dumps/elogs directory are dumps of the contents of the error and event log at the time that the dump was taken. An error or event log dump is created by using the **dumperrlog** command. This dumps the contents of the error or event log to the /dumps/elogs directory. If no file name prefix is supplied, the default `errlog_` is used. The full default file name is `errlog_NNNNNN_YYMMDD_HHMMSS`, where *NNNNNN* is the node front panel name. If the command is used with the **-prefix** parameter, the prefix value is used instead of `errlog`.

Dumps contained in the /dumps/feature directory are dumps of the featurization log. A featurization log dump is created by using the **dumpinternallog** command. This dumps the contents of the featurization log to the /dumps/feature directory to a file called `feature.txt`. Only one of these files exists, so every time the **dumpinternallog** command is run, this file is overwritten.

Dumps that are contained in the /dumps/iostats directory are dumps of the per-node I/O statistics for disks on the cluster. An I/O statistics dump is created by using the **startstats** command. As part of this command, you can specify a time interval for the statistics to be written to the file; the default is 15 minutes. Every time the time interval is encountered, the I/O statistics that have been collected are written to a file in the /dumps/iostats directory. The file names that are used for storing I/O statistics dumps are `Nm_stats_NNNNNN_YYMMDD_HHMMSS`, `Nv_stats_NNNNNN_YYMMDD_HHMMSS`,

`Nn_stats_NNNNNN_YYMMDD_HHMMSS`, and `Nd_stats_NNNNNN_YYMMDD_HHMMSS`, where `NNNNNN` is the node name for the MDisk, VDisk, node, or drive.

Dumps that are contained in the `/dumps/iotrace` directory are dumps of I/O trace data. The type of data that is traced depends on the options specified by the **settrace** command. The collection of the I/O trace data is started by using the **starttrace** command. The I/O trace data collection is stopped when the **stoptrace** command is used. It is when the trace is stopped that the data is written to the file. The file name is `prefix_NNNNNN_YYMMDD_HHMMSS`, where *prefix* is the value entered for the **filename** parameter in the **settrace** command, and `NNNNNN` is the node name.

Dumps that are contained in the `/dumps/mdisk` directory are copies of solid-state drive (SSD) MDisk internal logs. These dumps are created using the **triggerdrivedump** command. The file name is `mdiskdump_NNNNNN_MMMM_YYMMDD_HHMMSS`, where `NNNNNN` is the name of the node that contains the MDisk, and `MMMM` is the decimal ID of the MDisk.

Software upgrade packages are contained in the `/home/admin/upgrade` directory. These directories exist on every node in the cluster.

Dumps of support data from a disk drive are contained in the `/dumps/drive` directory. This data can help to identify problems with the drive, and does not contain any data that applications may have written to the drive.

Dumps from an enclosure or enclosures are contained in the `/dumps/enclosure` directory.

Dumps that are contained in the `/dumps` directory result from application abends. Such dumps are written to the `/dumps` directory. The default file names are `dump.NNNNNN.YYMMDD.HHMMSS`, where `NNNNNN` is the node front panel name. In addition to the dump file, there might be some trace files written to this directory that are named `NNNNNN.trc`.

Because files can only be copied from the current configuration node (using secure copy), you can issue the **cpdumps** command to copy the files from a nonconfiguration node to the current configuration node.

---

## Chapter 5. Array commands

Array commands capture information that can assist you with managing arrays.

---

### charray

Use the **charray** command to change array attributes.

#### Syntax

```
▶▶—charray— [-name —new_name_arg—] [-sparegoal —0-100—] [-balanced] —————▶▶
▶—mdisk_id | mdisk_name—▶▶
```

#### Parameters

##### -name

(Optional) The new name to apply to the array MDisk.

##### -sparegoal

(Optional) Sets the number of spares to protect the array members with.

##### -balanced

(Optional) Forces the array to balance and configure the member spare goals of the present drives.

##### *mdisk\_id*

Identifies (by ID) which array the MDisk command applies to.

##### *mdisk\_name*

Identifies (by user-defined name) which array the MDisk command applies to.

#### Description

This command changes an array's attributes.

#### Invocation examples

```
charray -name raid6mdisk0 0
charray -sparegoal 2
charray -balanced
```

#### The resulting output

No feedback

---

### charraymember

Use the **charraymember** command to modify an array member's attributes, or to swap a member of a RAID array with that of another drive.

#### Syntax

```
▶▶—charraymember— -member —member_id— —————▶▶
```

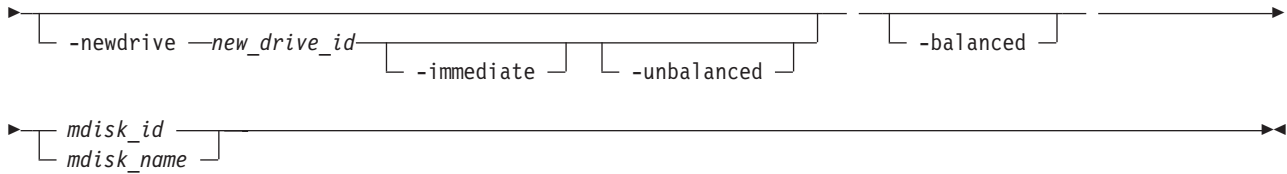

## Parameters

### **-member**

Identifies the array member index to be operated on.

### **-newdrive**

(Optional) Identifies the drive you want to add to the array.

### **-immediate**

(Optional) Specifies that the old disk is to be immediately removed from the array, and the new disk rebuilt. If you do not choose this option, exchange is used; this preserves redundancy during the rebuild.

### **-balanced**

(Optional) If specified, forces the array member spare goals to be set to those of present array member, those of an existing exchange, or those of the newDrive.

### **-unbalanced**

(Optional) Forces the array member change if the newDrive does not meet the array member goals.

### *mdisk\_id*

(Either the ID or the name is required.) Identifies which array the MDisk command applies to.

### *mdisk\_name*

(Either the ID or the name is required.) Identifies which array the MDisk command applies to.

## Description

This command modifies an array member's attributes, or to swap a member of a RAID array with that of another drive. Table 10 shows the command combination options.

Table 10. *charraymember* combination options

| Option                       | Description                                                                                                                                                                                                                                                                                                                                                                                                            |
|------------------------------|------------------------------------------------------------------------------------------------------------------------------------------------------------------------------------------------------------------------------------------------------------------------------------------------------------------------------------------------------------------------------------------------------------------------|
| -balanced                    | <ul style="list-style-type: none"> <li>Member goals are set to the properties of the existing member or exchange drive.</li> <li>The command will fail if the member is not populated with a drive.</li> <li>Member goals are set to the properties of the current member drives being exchanged into the array count as members.</li> <li>If no exchange exists, the existing member drive goals are used.</li> </ul> |
| -newdrive drive_id           | <ul style="list-style-type: none"> <li>The command processes the exchange, and does NOT update the member goals.</li> <li>You must specify a new drive that is an exact match for the member goals.</li> <li>The command will fail if the drive is not an exact match.</li> </ul>                                                                                                                                      |
| -newdrive drive_id -balanced | The processes the exchange and updates the member goals to the properties of the new drive.                                                                                                                                                                                                                                                                                                                            |

Table 10. *charraymember* combination options (continued)

| Option                            | Description                                                                                                                                                                                                                                                                                                                                                                                                                                                                      |
|-----------------------------------|----------------------------------------------------------------------------------------------------------------------------------------------------------------------------------------------------------------------------------------------------------------------------------------------------------------------------------------------------------------------------------------------------------------------------------------------------------------------------------|
| -newdrive drive_id<br>-unbalanced | <ul style="list-style-type: none"> <li>• The command processes the exchange and does NOT update the member goals.</li> <li>• This is only permitted when the array is degraded and the member is empty.</li> <li>• This means -immediate is mute, the exchange will always be immediate.</li> <li>• Later, if drives are a sufficient member goal match, the array rebalance will select those drives.</li> <li>• A balancing exchange will restart the member goals.</li> </ul> |

### An invocation example

To swap a spare/candidate drive for a member 0 drive using exchange:

```
charraymember -member 0 -newdrive 4 mdisk2
```

### An invocation example

To swap a spare/candidate drive for a member 1 drive and start component rebuild for the new member:

```
charraymember -member 1 -newdrive 3 -immediate mdisk3
```

### An invocation example

To swap in a spare/candidate drive for member index 2. If there is an drive present there then the exchange is:

```
charraymember -member 2 -newdrive 4 mdisk4
```

### An invocation example

To force member 4 to change its spare goals to its associated drive:

```
charraymember -member 4 -balanced mdisk6
```

### An invocation example

To force an exchange and make the array change its goals to the new drive:

```
charraymember -member 3 -newdrive 9 -balanced mdisk5
```

### An invocation example

To force an unbalancing exchange when drive 8 does not match the goals:

```
charraymember -member 2 -newdrive 8 -unbalanced mdisk5
```

### An invocation example

To force an immediate exchange and make the array change its goals to the new drive:

```
charraymember -member 3 -newdrive 9 -balanced -immediate mdisk5
```

---

## lsarray

Use the **lsarray** command to list the array MDisks.

## Syntax

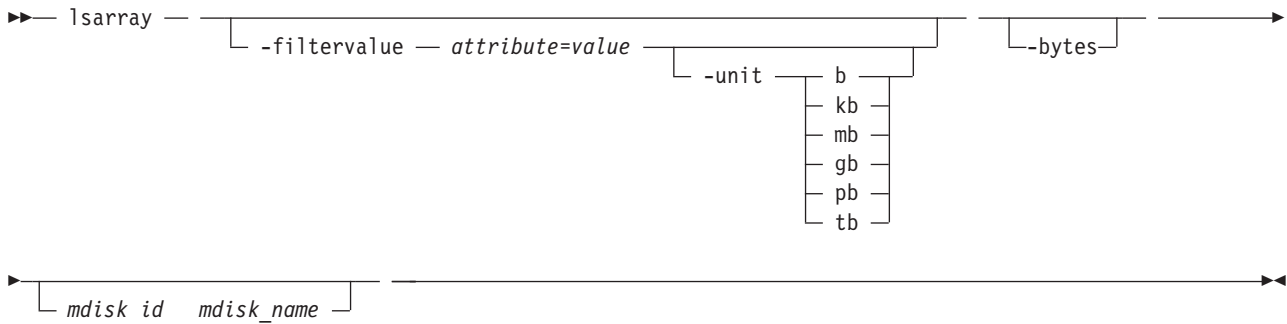

## Parameters

### **-filtervalue** *attribute=value*

(Optional) Specifies a list of one or more filter attributes matching the specified values; see **-filtervalue?** for the supported attributes. Only objects with a value that matches the filter attribute value are returned. If **capacity** is specified, the units must also be included.

**Note:** Some filters allow the use of a wildcard when entering the command. The following rules apply to the use of wildcards with the SAN Volume Controller CLI:

- The wildcard character is an asterisk (\*).
- The command can contain a maximum of one wildcard, which must be the first or last character in the string.
- When using a wildcard character, you must enclose the filter entry within double quotation marks (""), as follows:

```
lsarray -filtervalue "name=md*"
```

### **-filtervalue?**

(Optional) Includes all of the valid filter attributes in the report. The following filter attributes are valid for the **lsarray** command:

- mdisk\_id
- mdisk\_name
- status
- mode
- mdisk\_grp\_id
- mdisk\_grp\_name
- capacity
- fast\_write\_state
- raid\_status
- raid\_level
- redundancy
- strip\_size
- write\_verify
- spare\_goal
- spare\_protection\_min
- balanced
- tier

Any parameters specified with the **-filtervalue?** parameter are ignored.



**-bytes**

(Optional) Requests output of capacities in bytes (instead of rounded values).

**mdisk\_id**

(Optional) The identity of the array MDisk.

**mdisk\_name**

(Optional) The MDisk name that you provided.

**Description**

This command returns a concise list or a detailed view of array MDisks visible to the cluster. The **lsmdisk** command provides the potential output for array MDisks.

*Table 11. MDisk output*

| Attribute            | Values                                                                                                                                                                                                                                                                                                                                                                                                                                                                                                               |
|----------------------|----------------------------------------------------------------------------------------------------------------------------------------------------------------------------------------------------------------------------------------------------------------------------------------------------------------------------------------------------------------------------------------------------------------------------------------------------------------------------------------------------------------------|
| status               | <ul style="list-style-type: none"> <li>• online</li> <li>• offline</li> <li>• excluded</li> <li>• degraded (applies only to internal MDisks)</li> </ul>                                                                                                                                                                                                                                                                                                                                                              |
| mode                 | unmanaged, managed, image, array                                                                                                                                                                                                                                                                                                                                                                                                                                                                                     |
| quorum_index         | 0, 1, 2, or blank if the MDisk is not being used as a quorum disk                                                                                                                                                                                                                                                                                                                                                                                                                                                    |
| block_size           | 512, 524 bytes in each block of storage                                                                                                                                                                                                                                                                                                                                                                                                                                                                              |
| ctrl_type            | 4, 6, where 6 is a solid-state drive (SSD) attached inside a node and 4 is any other device                                                                                                                                                                                                                                                                                                                                                                                                                          |
| tier                 | <p>The tier this MDisk has been assigned to by auto-detection (for internal arrays) or by the user:</p> <ul style="list-style-type: none"> <li>• generic_ssd</li> <li>• generic_hdd (the default value for newly discovered or external MDisk)</li> </ul> <p><b>Note:</b> You can change this value using the <code>chmdisk</code> command.</p>                                                                                                                                                                      |
| raid_status          | <ul style="list-style-type: none"> <li>• offline - the array is offline on all nodes</li> <li>• degraded - the array has deconfigured or offline members; the array is not fully redundant</li> <li>• syncing - array members are all online, the array is syncing parity or mirrors to achieve redundancy</li> <li>• initting - array members are all online, the array is initializing; the array is fully redundant</li> <li>• online - array members are all online, and the array is fully redundant</li> </ul> |
| raid_level           | The RAID level of the array (RAID0, RAID1, RAID5, RAID6, RAID10).                                                                                                                                                                                                                                                                                                                                                                                                                                                    |
| redundancy           | The number of how many member disks can fail before the array fails.                                                                                                                                                                                                                                                                                                                                                                                                                                                 |
| strip_size           | The strip size of the array (in KB).                                                                                                                                                                                                                                                                                                                                                                                                                                                                                 |
| spare_goal           | The number of spares that the array members should be protected by.                                                                                                                                                                                                                                                                                                                                                                                                                                                  |
| spare_protection_min | The minimum number of spares that an array member is protected by.                                                                                                                                                                                                                                                                                                                                                                                                                                                   |
| balanced             | <p>Describes if the array is balanced to its spare goals:</p> <ul style="list-style-type: none"> <li>• exact: all populated members have exact capability match, exact location match</li> <li>• yes: all populated members have at least exact capability match, exact chain, or different enclosure or slot</li> <li>• no: anything else</li> </ul>                                                                                                                                                                |

The following define the status fields:

#### **Online**

The MDisk is online and available.

#### **Degraded**

(Internal MDisks only) The array has members that are degraded, or the `raid_status` is degraded.

#### **Offline**

All paths to the MDisk are lost.

#### **Excluded**

The MDisk is excluded from use by the cluster; the MDisk port error count exceeded the threshold.

### **A concise invocation example**

```
lsarray -delim :
```

#### **The resulting output**

```
mdisk_id:mdisk_name:status:mdisk_grp_id:mdisk_grp_name:capacity:raid_status:
raid_level:redundancy:strip_size:tier
1:mdisk1:online:0:mdiskgrp0:68.4GB:online:raid0:0:256:generic_hdd
2:mdisk2:online:0:mdiskgrp0:88.4GB:syncing:raid5:1:256:generic_hdd
533:mdisk533:degraded:1:mdiskgrp1:78.2GB:syncing:raid6:2:128:generic_hdd
534:mdisk534:online:2:mdiskgrp1:94.2GB:initting:raid6:2:64:generic_ssd
```

### **A full invocation example**

```
lsarray mdisk1
```

#### **The resulting output**

```
mdisk_id:1
mdisk_name:mdisk1
status:online
mode:array
mdisk_grp_id:0
mdisk_grp_name:mdiskgrp0
capacity:68.4GB
quorum_index:
block_size:
controller_name:
ctrl_type:
ctrl_WWNN:
controller_id:
path_count:
max_path_count:
ctrl_LUN_#:
UID:
preferred_WWPN:
active_WWPN:
fast_write_state:empty
raid_status:online
raid_level:raid0
redundancy:0
strip_size:256
spare_goal:2
spare_protection_min:2
balanced:yes
tier:generic_hdd
```

---

## **Isarrayinitprogress**

Use the `lsarrayinitprogress` command to view the progress of array background initialization that occurs after creation.

## Syntax

```
lsarrayinitprogress [mdisk id | mdisk_name]
```

## Parameters

### **mdisk\_id**

(Optional) The identity of the array MDisk.

### **mdisk\_name**

(Optional) The user-defined MDisk name.

## Description

This command shows the progress of array background initialization. Table 12 shows possible outputs.

*Table 12. lsarrayinitprogress output*

| Attribute                 | Value                                                            |
|---------------------------|------------------------------------------------------------------|
| progress                  | The percentage of initialization task that has been completed.   |
| estimated_completion_time | The expected initialization task completion time (YYMMDDHHMMSS). |

### **A concise invocation example**

```
lsarrayinitprogress -delim :
```

### **The resulting output**

```
mdisk_id:mdisk_name:progress:estimated_completion_time
0:mdisk0:50:070301120000
1:mdisk1:51:070301130000
2:mdisk2:32:070301153500
```

### **A concise invocation (qualified with MDisk) example**

```
lsarrayinitprogress -delim : mdisk2
```

### **The resulting output**

```
mdisk_id:mdisk_name:progress:estimated_completion_time
2:mdisk2:32:070301153500
```

### **An invocation example for an array that has finished initialization**

```
lsarrayinitprogress -delim : mdisk4
```

### **The resulting output**

```
mdisk_id:mdisk_name:progress:estimated_completion_time
4:mdisk4:100:
```

---

## lsarraylba

Use the **lsarraylba** command to permit an array logical block address (LBA) to be found from a drive and LBA.

## Syntax

```
▶▶ lsarraylba [-drive_lba - lba - -drive - drive_id]
```

## Parameters

### -drive\_lba

The LBA on drive that you want to convert to the array LBA. The LBA must be specified in hex, with a 0x prefix.

### -drive

The ID of the drive you want to view.

## Description

This command enables you to permit an array LBA to be found from a drive and LBA. Table 13 shows possible outputs.

Table 13. lsarraylba output

| Attribute   | Value                                                                                                                  |
|-------------|------------------------------------------------------------------------------------------------------------------------|
| type        | The type of MDisk extent allocation: <ul style="list-style-type: none"><li>• allocated</li><li>• unallocated</li></ul> |
| mdisk_lba   | The LBA on the array MDisk (blank if none).                                                                            |
| mdisk_start | The start of range of LBAs (strip) on the array MDisk (blank if none).                                                 |
| mdisk_end   | The end of range of LBAs (strip) on the array MDisk (blank if none).                                                   |
| drive_start | The start of range of LBAs (strip) on the drive (blank if none).                                                       |
| drive_end   | The end of range of LBAs (strip) on the drive (blank if none).                                                         |

The following example shows:

- How a drive 2 LBA -xff maps to MDisk 2 LBA 0xff
- How the first 255 LBAs of drive 2 map to the second 255 LBAs of the MDisk.

### An invocation example

```
lsarraylba -drive_lba 0xff -drive 2 -delim :
```

### The resulting output

```
mdisk_id:mdisk_name:type:mdisk_lba:mdisk_start:mdisk_end:drive_start:drive_end
0:mdisk2:allocated:0x000000000000001ff:0x00000000000000100:0x00000000000001ff:
0x0000000000000000:0x00000000000000ff
```

---

## lsarraymember

Use the lsarraymember command to list the member drives of one or more array MDisks.

## Syntax

```
▶▶ lsarraymember [-bytes -mdisk_id -mdisk_name]
```

## Parameters

### **mdisk\_id**

(Optional) The identity of the array MDisk.

### **mdisk\_name**

(Optional) The MDisk name that you provided.

## Description

This command lists the member drives of one or more array MDisks. It describes positions within an array that not occupied by a drive. The positions determine how mirroring the RAID's will take place; for example, it determines if  $x$  is mirrored to  $y$  for RAID-10, where parity starts from RAID-5.

Table 14 provides the potential output for this command.

*Table 14. Isarraymemberoutput*

| Attribute        | Value                                                                                                                                                                                                                                                                                                                                   |
|------------------|-----------------------------------------------------------------------------------------------------------------------------------------------------------------------------------------------------------------------------------------------------------------------------------------------------------------------------------------|
| member_id        | The identity of the array member; represents drive order in RAID array                                                                                                                                                                                                                                                                  |
| drive_id         | The identity of the drive for member ID, or the source drive if an exchange is in progress (blank if there is none configured).                                                                                                                                                                                                         |
| new_drive_id     | The ID of the drive being exchanged with this member ID (blank if there is none)                                                                                                                                                                                                                                                        |
| spare_protection | The number of spares protecting the array member                                                                                                                                                                                                                                                                                        |
| balanced         | If the array member drive matches the spare goals: <ul style="list-style-type: none"><li>• exact - exact capability match, exact location match</li><li>• yes - exact capability match, exact chain, different enclosure or slot</li><li>• no - anything else</li><li>• (blank) - there is no drive configured for the member</li></ul> |

### A concise invocation example

```
lsarraymember -delim :
```

### The resulting output

```
lsarraymember -delim :
mdisk_id:mdisk_name:member_id:drive_id:new_drive_id:spare_protection:balanced
2:mdisk1:0:55::1:exact
2:mdisk1:1:56::1:exact
2:mdisk2:0:0::2:exact
2:mdisk2:1:2:5:3:exact
2:mdisk2:2:::
2:mdisk2:3:8::0:no
```

### A concise invocation example (qualified with MDisk)

```
lsarraymember mdisk2 -delim :
```

### The resulting output

```
mdisk_id:mdisk_name:member_id:drive_id:new_drive_id:spare_protection:balanced
2:mdisk2:0:0::2:exact
2:mdisk2:1:2:5:3:exact
2:mdisk2:2:::
2:mdisk2:3:8::0:no
```

**Note:** From this output, you can see that:

- The array has four members (possibly a 4-member RAID-10 array).
- The second array member is undergoing exchange for drive5.

- The third array member is not configured. It might have gone offline or failed, without a hot spare available.
- The fourth array member has no spare protection and is not balanced.

### An invocation example (two arrays)

```
lsarraymember -delim :
```

#### The resulting output

```
mdisk_id:mdisk_name:member_id:drive_id:new_drive_id:spare_protection:balanced
2:mdisk1:0:55:::1:exact
2:mdisk1:1:56:::1:exact
2:mdisk2:0:0:::2:exact
2:mdisk2:1:2:5:::3:exact
2:mdisk2:2:::::
2:mdisk2:3:8:::0:no
```

### An invocation example (an array expanding from membership (55,56) to (55,57,58))

```
lsarraymember -delim : mdisk3
```

#### The resulting output

```
mdisk_id:mdisk_name:member_id:drive_id:new_drive_id:spare_protection:balanced
3:mdisk3:0:55::55:1:exact
3:mdisk3:1:56::57:1:exact
3:mdisk3:2:::58:1:exact
```

### An invocation example (an array contracting from membership (55,57,58) to (55,56))

```
lsarraymember -delim : mdisk3
```

#### The resulting output

```
mdisk_id:mdisk_name:member_id:drive_id:new_drive_id:spare_protection:balanced
3:mdisk3:0:55::55:1:exact
3:mdisk3:1:57::56:1:exact
3:mdisk3:2:58:::1:exact
```

## lsarraymembergoals

Use the `lsarraymembergoals` command to list the spare goals for member drives of one or more array MDisks.

### Syntax

```

>> lsarraymembergoals —————>>>
 |_____|
 | -bytes -mdisk_id -mdisk_name |

```

### Parameters

#### -bytes

(Optional) Requests output of capacities in bytes (instead of rounded values).

#### mdisk\_id

(Optional) The identity of the array MDisk.

#### mdisk\_name

(Optional) The MDisk name that you provided.

## Description

This command lists the spare goals for member drives of one or more array MDisks. Table 15 provides the potential output for this command.

Table 15. *lsarraymembergoals* output

| Attribute         | Values                                                                                                                                           |
|-------------------|--------------------------------------------------------------------------------------------------------------------------------------------------|
| member_id         | The ID of the array member which represents the drive order in the RAID array.                                                                   |
| drive_id          | The ID of the drive for the member ID (blank if none is configured).                                                                             |
| capacity_goal     | The capacity goal for the array member (same for all members in the array).                                                                      |
| tech_type_goal    | The technology goal for the array member: <ul style="list-style-type: none"><li>• sas_ssd</li><li>• sas_hdd</li><li>• sas_nearline_hdd</li></ul> |
| RPM_goal          | The RPM goal for array member (blank for SSDs).                                                                                                  |
| enclosure_id_goal | The ID of the member enclosure goal (blank if any can be selected).                                                                              |
| slot_id_goal      | The ID of the member slot goal.                                                                                                                  |
| node_id_goal      | The node ID of the goal.                                                                                                                         |

### An invocation example (a four-member RAID 10 SAS array that is split across chains)

```
lsarraymembergoals mdisk2 -delim :
```

#### The resulting output

```
mdisk_id:mdisk_name:member_id:drive_id:capacity_goal:
tech_type_goal:RPM_goal:enclosure_id_goal:slot_id_goal
2:mdisk2:0:0:68.4GB:sas_hdd:15000:1:1
2:mdisk2:1:17:68.4GB:sas_hdd:15000:1:2
2:mdisk2:2:1:68.4GB:sas_hdd:15000:14:1
2:mdisk2:3:18:68.4GB:sas_hdd:15000:14:2
```

### An invocation example (a six-member RAID 10 SAS or SATA array )

```
lsarraymembergoals mdisk3 -delim :
```

#### The resulting output

```
mdisk_id:mdisk_name:member_id:drive_id:capacity_goal:
tech_type_goal:RPM_goal:enclosure_id_goal:slot_id_goal
3:mdisk3:0:10:155.0GB:sas_ssd::1:4
3:mdisk3:1:21:155.0GB:sas_hdd:15000:2:3
3:mdisk3:2:12:155.0GB:sas_nearline_hdd:7200:7:3
3:mdisk3:4:23:155.0GB:sas_ssd::2:2
3:mdisk3:5:14:155.0GB:sas_nearline_hdd:7200:9:3
3:mdisk3:6:25:155.0GB:sas_hdd:15000:2:8
```

### An invocation example (a four-member RAID 0 SAS array contained within a single enclosure)

```
lsarraymembergoals mdisk4 -delim :
```

#### The resulting output

```
mdisk_id:mdisk_name:member_id:drive_id:capacity_goal:
tech_type_goal:RPM_goal:enclosure_id_goal:slot_id_goal
2:mdisk2:0:0:222.0GB:sas_nearline_hdd:15000:1:1
2:mdisk2:1:1:222.0GB:sas_nearline_hdd:15000:1:2
2:mdisk2:2:2:222.0GB:sas_nearline_hdd:15000:1:3
2:mdisk2:3:3:222.0GB:sas_nearline_hdd:15000:1:4
```

---

## lsarraymemberprogress

Use the `lsarraymemberprogress` command to display array member background process status.

### Syntax

```
lsarraymemberprogress [mdisk_id—mdisk_name]
```

### Parameters

**mdisk\_id**

(Optional) The identity of the array MDisk.

**mdisk\_name**

(Optional) The MDisk name that you provided.

### Description

This command displays array member background process status. Exchange cannot start on a rebuilding member because both component rebuild and exchange are shown in the same view. Table 16 provides the potential output for this command.

Table 16. *lsarraymemberprogress* output

| Attribute                 | Value                                                                                              |
|---------------------------|----------------------------------------------------------------------------------------------------|
| member_id                 | The array member index.                                                                            |
| drive_id                  | The ID of the drive.                                                                               |
| task                      | The identity of task: <ul style="list-style-type: none"><li>• rebuild</li><li>• exchange</li></ul> |
| new_drive_id              | The identity of drive being exchanged.                                                             |
| progress                  | The task percentage complete.                                                                      |
| estimated_completion_time | The expected task completion time (YYMMDDHHMMSS; blank if completion time unknown).                |

### A concise invocation example

```
lsarraymemberprogress -delim :
```

### The resulting output

```
mdisk_id:mdisk_name:member_id:drive_id:task:new_drive_id:progress:estimated_completion_time
0:mdisk0:2:3:rebuild::50:070301120000
1:mdisk1:0:5:rebuild::51:070301130000
2:mdisk2:4:1:exchange:12:32:070301153500
2:mdisk2:5:16:exchange:13:0:
2:mdisk2:5:17:exchange:14:0:
```

### An MDisk qualified concise example

```
lsarraymemberprogress mdisk2
```

### The resulting output



```
mdisk_id:mdisk_name:member_id:drive_id:task:new_drive_id:progress:estimated_completion_time
2:mdisk2:4:1:exchange:12:32:070301153500
2:mdisk2:5:16:exchange:13:0:
2:mdisk2:5:17:exchange:14:0:
```

---

## Isarraysyncprogress

The `Isarraysyncprogress` command displays how synchronized a RAID array is.

### Syntax

```
►►—lsarraysyncprogress—┐
 └─mdisk_id─┐
 └─mdisk_name─┘
```

### Parameters

*mdisk\_id*

(Optional) The ID of the MDisk you want to view.

*mdisk\_name*

(Optional) The user-defined name of the MDisk you want to view.

### Description

This command shows you how synchronized a RAID array is. It includes internal activity that is working toward a fully synchronized array. Table 17 provides the potential output.

*Table 17. Isarraysyncprogress output*

| Attribute                 | Value                                                                                          |
|---------------------------|------------------------------------------------------------------------------------------------|
| progress                  | The percentage of the array that is synchronized.                                              |
| estimated_completion_time | The expected synchronization completion time (YYMMDDHHMMSS; blank if completion time unknown). |

#### A concise invocation example

```
lsarraysyncprogress -delim :
```

#### The resulting output

```
mdisk_id:mdisk_name:progress:estimated_completion_time
0:mdisk0:50:070301120000
1:mdisk1:51:070301130000
2:mdisk2:32:070301153500
```

#### A concise view (qualified with mdisk id for mdisk2) invocation example

```
lsarraysyncprogress -delim : mdisk2
```

#### The resulting output

```
mdisk_id:mdisk_name:progress:estimated_completion_time
2:mdisk2:32:070301153500
```

#### A concise view (qualified with mdisk id for in sync mdisk10) invocation example

```
lsarraysyncprogress -delim : mdisk10
```

#### The resulting output

mdisk\_id:mdisk\_name:progress:estimated\_completion\_time  
0:mdisk0:100:

## mkarray

Use the **mkarray** command to create an MDisk RAID array and add it to an MDisk group (storage pool).

### Syntax

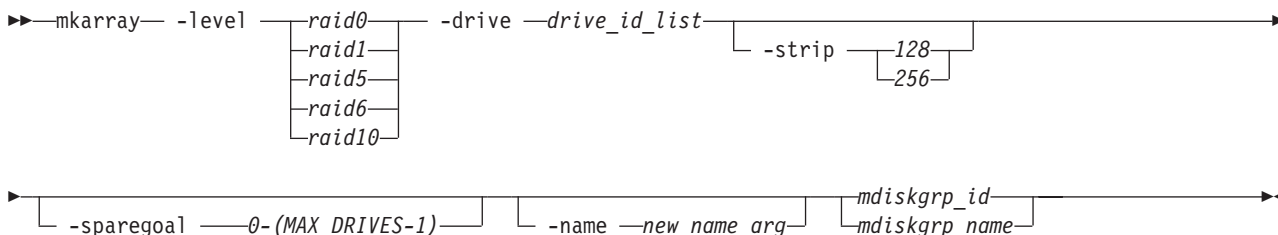

### Parameters

#### **-level**

Sets the RAID level for the array MDisk being created.

#### **-drive**

Identifies the drive or drives to use as members of the RAID array.

Drives are specified as a sequence of mirrored drive pairs. For example, if an array is created with `-drive a:b:c:d`, drive *b* contains the mirror copy of drive *a*, and drive *d* contains the mirror copy of drive *c*. The following requirements apply for certain RAID levels:

- RAID-0: All drives in a RAID-0 array of internal drives must be located in the same node.
- RAID-1: The pair of drives must contain one drive from one node in the I/O group, and one drive from the other node.
- RAID-10: The drives are specified as a sequence of drive pairs. Each pair of drives must contain one drive from a node in the I/O group, and a drive from the other node.

#### **-strip**

(Optional) Sets strip size (in kilobytes) for the array MDisk being created. The default is 256 KB.

#### **-sparegoal**

(Optional) Sets the number of spares that this array's members should be protected by. The default is 1 (except for RAID 0 arrays, which have a default of 0).

#### **-name**

(Optional) Specifies the name to which you want to apply the array MDisk.

#### **mdiskgrp\_id**

Identifies the MDisk group (by ID) to which you want to add the created array mdisk.

#### **mdiskgrp\_name**

Identifies MDisk group (by the user-defined name) to which you want to add created array MDisks.

### Description

This command creates an array MDisk RAID array and adds it to an MDisk group. Although the array's tier is automatically determined, you can change it later using the **chmdisk** command.

#### Standard output

MDisk, id [x], successfully created

### An invocation example (to create fully redundant arrays)

```
mkarray -level raid0 -drive 0:1:2:3 raid0grp
```

### The resulting output

```
MDisk, id [0], successfully created
```

### An invocation example (to create fully redundant arrays)

```
mkarray -level raid1 -drive 4:5 -strip 128 mdiskgrp4
```

### The resulting output

```
MDisk, id [1], successfully created
```

### An invocation example (to create fully redundant arrays)

```
mkarray -level raid6 -drive 6:7:8:9:10 raid6grp
```

### The resulting output

```
MDisk, id [2], successfully created
```

---

## recoverarray

Use the **recoverarray** command to recover a specific corrupt array in a dead domain scenario.

### Syntax

```
►►—recoverarray—mdisk_id—mdisk_name—◄◄
```

### Parameters

#### **mdisk\_id**

Identifies (by ID)

#### **mdisk\_name**

Identifies (by user-assigned name)

### Description

This command recovers a specific corrupt array. An array has metadata that represents ongoing/pending platform writes that is lost when the domain nodes are lost.

### An invocation example

```
recoverarray mdisk1
```

### The resulting output

There is no output if the command is successful.

---

## recoverarraybycluster

Use the **recoverarraybycluster** command to recover a specific corrupt array in a dead domain scenario.

### Syntax

```
►►—recoverarraybycluster—◄◄
```

## Parameters

None.

## Description

Use this command to recover the corrupt arrays in a dead domain scenario.

### An invocation example

```
recoverarraybycluster
```

### The resulting output

There is no output if the command is successful.

---

## rmarray

Use the **rmarray** command to remove an array MDisk from the configuration.

## Syntax

```
►►—rmarray— -mdisk — mdisk_id_list — mdisk_group_id —►►
 └─ mdisk_name_list ─┘ └─ -force ─┘ └─ mdisk_group_name ─┘
```

## Parameters

### -mdisk

Identifies the array MDisk or MDisks to remove from the storage pool

### -force

(Optional) Forces a remove when the MDisk has allocated extents by migrating the used extents to free extents in the storage pool

### mdiskgrp\_id

| Identifies (by ID) the MDisk group to remove the created array MDisk from.

### mdiskgrp\_name

| Identifies (by user-defined name) the MDisk group to remove the created array MDisk from.

## Description

This command removes an array MDisk from the configuration. Each array is divided into candidate drives.

### An invocation example

```
rmarray -mdisk 6 mdiskgrp10
```

### The resulting output

No feedback

---

## Chapter 6. Audit log commands

An audit log keeps track of action commands that are issued through a Secure Shell (SSH) session or through the management GUI.

The audit log entries provide the following information:

- Identity of the user who issued the action command
- The name of the actionable command
- The timestamp of when the actionable command was issued on the configuration node
- The parameters which were issued with the actionable command

The following commands are not documented in the audit log:

- `dumpconfig`
- `cpdumps`
- `cleardumps`
- `finderr`
- `dumperrlog`
- `dumpinternallog`
- `svcservicetask dumperrlog`
- `svcservicetask finderr`

The following items are also not documented in the audit log:

- Commands that fail are not logged
- A result code of 0 (success) or 1 (success in progress) is not logged
- Result object ID of node type (for the `addnode` command) is not logged
- Views are not logged

---

### catauditlog

Use the `catauditlog` command to display the in-memory contents of the audit log.

#### Syntax

```
▶▶ catauditlog — [-first — number_of_entries_to_return] ▶▶
```

#### Parameters

`-first number_of_entries_to_return`  
(Optional) Specifies the number of most recent entries to display.

#### Description

This command lists a specified number of the most recently audited commands.

The in-memory portion of the audit log can hold approximately 1 MB of audit information. Depending on the command text size and the number of parameters, 1 MB records approximately 6000 commands.

Once the in-memory audit log has reached its maximum capacity, the log is written to a local file on the configuration node in the `/dumps/audit` directory. The **catauditlog** command only displays the in-memory part of the audit log; the on-disk part of the audit log is in readable text format and does not need any special command to decode it.

The in-memory log entries are reset and cleared automatically, ready to start accumulating new commands. The on-disk portion of the audit log can then be analyzed at a later date.

The **lsdumps** command with **-prefix /dumps/audit** can be used to list the files that are on the disk.

The in-memory portion of the audit log can be transferred to an on-disk file using the **dumpauditlog** command. This action clears the in-memory portion of the log.

In the following example, the user has specified that they want to list the five most recent audit log entries.

### An invocation example

```
catauditlog -delim : -first 5
```

### The resulting output

```
audit_seq_no:timestamp:cluster_user:ssh_ip_address:result:res_obj_id:action_cmd
35:091012114520:superuser:9.20.160.249:0::dumpauditlog
36:091012115150:superuser:9.20.160.249:0::chquorum -mdisk 45 3
37:091012115256:superuser:9.20.160.249:0::chvdisk -name vdisk_master 1
38:091012115302:superuser:9.20.160.249:0::chvdisk -name vdisk_aux 2
39:091012115328:superuser:9.20.160.249:0::chvdisk -name disk 3
```

---

## dumpauditlog

Use the **dumpauditlog** command to reset or clear the contents of the in-memory audit log. The contents of the audit log are sent to a file in the `/dumps/audit` directory on the current configuration node.

### Syntax

▶— dumpauditlog —▶

### Parameters

There are no parameters.

### Description

This command dumps the contents of the audit log to a file on the current configuration node. It also clears the contents of the audit log. This command is logged as the first entry in the new audit log.

Audit log dumps are automatically maintained in the `/dumps/audit` directory. The local file system space is used by audit log dumps and is limited to 200 MB on any node in the cluster. The space limit is maintained automatically by deleting the minimum number of old audit log dump files so that the `/dumps/audit` directory space is reduced below 200 MB. This deletion occurs once per day on every node in the cluster. The oldest audit log dump files are considered to be the ones with the lowest audit log sequence number. Also, audit log dump files with a cluster ID number that does not match the current one are considered to be older than files that match the cluster ID, regardless of sequence number.

Other than by running dumps (or copying dump files among nodes), you cannot alter the contents of the audit directory. Each dump file name is generated automatically in the following format:

`auditlog_firstseq_lastseq_timestamp_clusterid`

where

- *firstseq* is the audit log sequence number of the first entry in the log
- *lastseq* is the audit log sequence number of the last entry in the log
- *timestamp* is the timestamp of the last entry in the audit log that is being dumped
- *clusterid* is the cluster ID at the time that the dump was created

The audit log dump files names cannot be changed.

The audit log entries in the dump files contain the same information as displayed by the **catauditlog** command; however, the **dumpauditlog** command displays the information with one field per line. The **lsauditlogdumps** command displays a list of the audit log dumps that are available on the nodes in the cluster.

### An invocation example

```
dumpauditlog
```

### The resulting output

No feedback

---

## lsauditlogdumps (Deprecated)

**Attention:** The **svcinfo lsauditlogdumps** command is deprecated. Use the **svcinfo lsdumps** command to display a list of files in a particular dumps directory.

Discontinued.





---

## Chapter 7. Backup and restore commands

The following commands are used for backing up and restoring configuration information with the SAN Volume Controller.

---

### backup

Use the **backup** command to back up your configuration. You can enter this command any time after a cluster has been created.

#### Syntax

```
svsconfig -- backup [-quiet] [-v on | off]
```

#### Parameters

##### -quiet

Suppresses standard output (STDOUT) messages from the console.

##### -v on | off

On means verbose messages are displayed. Off means normal messages (the default) are displayed.

#### Description

The **backup** command extracts configuration information from the cluster, allowing you to restore your configuration whenever necessary. The **backup** command produces **svc.config.backup.xml**, **svc.config.backup.sh**, and **svsconfig.backup.log** files and saves them in the **/tmp** directory. The **.xml** file contains the extracted configuration information; the **.sh** file contains a script of the commands used to determine the configuration information; and the **.log** file contains details about command usage.

**Note:** If a previous **svc.config.backup.xml** file exists in **/tmp**, it is archived as **svc.config.backup.bak**; only one archive file is stored in the **/tmp** directory.

The underscore character (**\_**) prefix is reserved for backup and restore command usage; do not use the underscore character in any object names.

#### An invocation example

```
svsconfig backup
```

#### The resulting output

```
No feedback
```

---

### clear

Use the **clear** command to erase files in the **/tmp** directory that were previously produced by other **svsconfig** commands. You can enter this command any time after a cluster has been created.

## Syntax

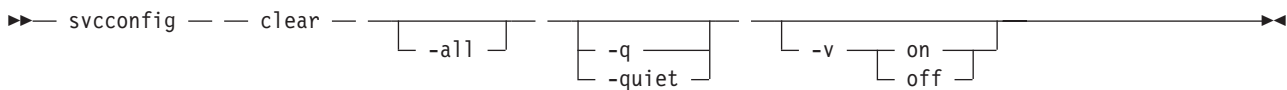

## Parameters

### -all

Erases all configuration files.

### -q | quiet

Suppresses console output (STDOUT).

### -v on | off

Produces verbose output (on); the default is regular output (off).

## Description

This command erases configuration files on the current config node.

You can use the **svcconfig clear** command without the **-all** parameter to erase files of the form:

```
/tmp/svc.config*.sh
/tmp/svc.config*.log
```

You can use the **svcconfig clear** command with the **-all** parameter to erase files of the form:

```
/tmp/svc.config*.sh
/tmp/svc.config*.log
/tmp/svc.config*.xml
/tmp/svc.config*.bak
```

## An invocation example

```
svcconfig clear -all
```

## The resulting output

No feedback

---

## help

Use the **help** command to obtain summary information about the syntax of the **svcconfig** command. You can enter this command any time after a cluster has been created.

## Syntax

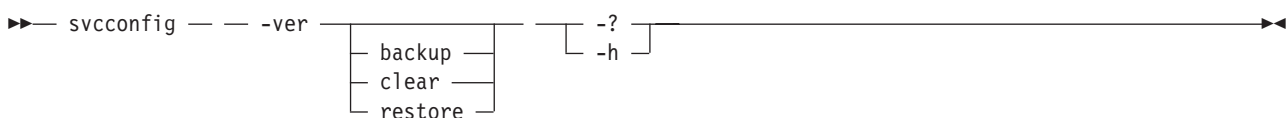

## Parameters

### -ver

Returns the version number for the **svcconfig** command.

### (action) -h | -?

Provides command help: the possible values for (action) are backup, clear, and restore.

**-h | -?**

Provides general help.

## Description

This command provides syntax help for `svcconfig`.

### An invocation example

```
svcconfig -ver
svcconfig -?
svcconfig backup -h
```

### The resulting output

The help text displays.

---

## restore

The **restore** command uses the configuration files in the `/tmp` directory to restore the cluster to its previous configuration.

## Syntax

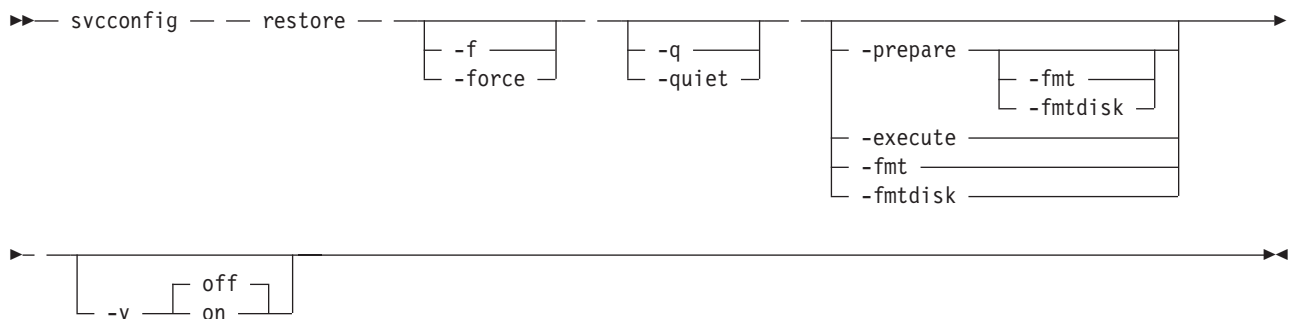

## Parameters

**-f | force**

Forces continued processing where possible.

**-q | quiet**

Suppresses console output (STDOUT).

**-prepare**

Checks the current configuration against the information in `svc.config.backup.xml` on the configuration to be restored. Prepares commands for processing in `svc.config.restore.sh`, and produces a log of events in `svc.config.restore.prepare`.

**-fmt | fmtdisk**

Includes the `-fmtdisk` option on all `mkvdisk` commands to be issued. Not allowed with the `-execute` parameter.

**-execute**

Runs the command script `svc.config.restore.sh`. Produces a log of events in `svc.config.restore.execute.log`.

**-v on | off**

Produces verbose output (on); the default is regular output (off).

## Description

The **restore** command restores the target cluster configuration from the **svc.config.backup.xml** file in the configuration files directory. If neither the **-prepare** nor **-execute** option is specified, the command performs both phases in sequence, and only a single event log, **svc.config.restore.log**, is produced.

The restore operation is also called T4 (Tier 4) Recovery, and should be used on a cluster that has just been started. It should not be used on a cluster that already has any nonautomatic objects configured, such as MDisk groups (storage pools) or VDIs (volumes).

The restore operation is performed in two phases:

1. Prepare
2. Execute

The command pauses for 8 minutes if any nodes are added during this process. You are informed of this at run-time.

The configuration files directory is **/tmp**.

### An invocation example

```
svcconfig restore -prepare -fmt
svcconfig restore -execute
svcconfig restore
```

### The resulting output

No feedback

---

## Chapter 8. Clustered system commands

Clustered system commands are used to monitor and modify clustered systems.

A clustered system consists of up to four pairs of nodes that provide a single configuration and service interface. There are a number of clustered system commands available for various tasks.

### **addnode**

Adds a new (candidate) node to an existing clustered system.

### **cfgportip**

Assigns an IP address to each node ethernet port for iSCSI I/O.

### **chcluster**

Modifies the attributes of an existing clustered system.

### **chclusterip**

Modifies the IP configuration parameters for the clustered system.

### **chiogrp**

Modifies the name of an I/O group or the amount of memory that is available for Copy Services or volume mirroring.

### **chnode**

Changes the name assigned to a node.

### **cleardumps**

Cleans the various dump directories on a specified node.

### **cpdumps**

Copies dump files from a nonconfiguration node onto the configuration node.

### **detectmdisk**

Rescans the Fibre Channel network for new managed disks.

### **ping**

Used to diagnose IP configuration problems by checking whether the specified IP address is accessible from the configuration node.

### **rmnode**

Deletes a node from the clustered system.

### **rmportip**

Removes an iSCSI IP address from a node ethernet port.

### **setclustertime**

Sets the time for the clustered system.

### **setpwdreset**

Changes the status of the password-reset feature for the display panel.

### **settimezone**

Sets the time zone for the clustered system.

### **startstats**

Starts the collection of per-node statistics for volumes, managed disks (MDisks), and nodes.

### **stopcluster**

Shuts down a single node or the entire clustered system.

---

## addnode

You can use the **addnode** command to add a new (candidate) node to an existing clustered system. You can enter this command any time after a clustered system has been created. If you are adding a new node to a clustered system, you must ensure that the model type of the new node is supported by the SAN Volume Controller software version of the clustered system. If the model type is not supported by the clustered system software, you must upgrade the clustered system to a software version that supports the model type of the new node.

### Syntax

```
▶▶ addnode — [-panelname — panel_name] [-wwnodename — wwnn_arg] [-name — new_name_arg]
▶ -iogrp — [iogroup_name | iogroup_id]
```

### Parameters

**-panelname** *panel\_name*

(Required if you do not specify the **-wwnodename** parameter) Specifies the node that you want to add to a clustered system by the name that is displayed on the display panel. You cannot use this parameter with the **-wwnodename** parameter.

**-wwnodename** *wwnn\_arg*

(Required if you do not specify the **-panelname** parameter) Specifies the node that you want to add to the clustered system by the worldwide node name (WWNN). You cannot use this parameter with the **-panelname** parameter.

**-name** *new\_name\_arg*

(Optional) Specifies a name for the node that you want to add to the clustered system. You can use this name in subsequent commands to refer to the node, instead of using the node ID.

**Note:** Node names supplied with the **-name** parameter on the **addnode** and **chnode** commands must not already be in use as node names or as node failover\_names.

If you assign a name, this name is displayed as the node name from then on. If you do not assign a name, a default name is used. The default name that is used depends on whether the node is replacing one that has previously been deleted. When a node is deleted, its name is retained in the I/O group as the failover name of its partner node. If no nodes remain in an I/O group, no failover names are retained. Only one failover name can be stored for each node. If you add a node into an I/O group that has a retained failover name and do not specify a node name, the retained failover name is assigned to this node. If you do not specify a name and there is no retained failover name, the name assigned has the format nodeX.

**Important:** The iSCSI Qualified Name (IQN) for each node is generated using the clustered system and node names. If you are using the iSCSI protocol and the target name for this node is already active on its partner node, and iSCSI hosts are attached to it. Adding the node with a different name changes the IQN of this node in the clustered system and might require reconfiguration of all iSCSI-attached hosts.

**-iogrp** *iogroup\_name* | *iogroup\_id*

(Required) Specifies the I/O group to which you want to add this node.

### Description

| **Note:** The **addnode** command is a SAN Volume Controller command. For Storwize V7000, use the **addcontrolenclosure** command.

This command adds a new node to the clustered system. You can obtain a list of candidate nodes (those that are not already assigned to a clustered system) by typing `lsnodecandidate`.

| **Note:** The `lsnodecandidate` command is a SAN Volume Controller command. For Storwize V7000, use  
| the `lscontrolenclosurecandidate` command.

| **Note:** This command is successful only if the node-enclosure clustered system ID matches the system, or  
| is blank.

Before you add a node to the clustered system, you must check to see if any of the following conditions are true. If the following conditions exist, failure to follow the procedures that are documented here might result in the corruption of all data that is managed by the clustered system.

- Is the new node being used to replace a failed node in the clustered system?
- Does the node being added to the clustered system use physical node hardware that has been used as a node in another clustered system, and are both clustered system recognized by the same hosts?

If any of the previous conditions are true, you must take the following actions:

1. Add the node to the same I/O group that it was previously in. You can use the command-line interface command `lsnode` or the management GUI to determine the WWNN of the clustered system nodes.
2. Shut down all of the hosts that use the clustered system, before you add the node back into the clustered system.
3. Add the node back to the clustered system before the hosts are restarted. If the I/O group information is unavailable or it is inconvenient to shut down and restart all of the hosts that use the clustered system, you can do the following:
  - a. On all of the hosts that are connected to the clustered system, unconfigure the Fibre Channel adapter device driver, the disk device driver, and the multipathing driver before you add the node to the clustered system.
  - b. Add the node to the clustered system, and then reconfigure the Fibre Channel adapter device driver, the disk device driver, and multipathing driver.

If you are adding a new node to a clustered system, take the following actions:

1. Ensure that the model type of the new node is supported by the SAN Volume Controller software version of the clustered system. If the model type is not supported by the clustered system software, you must upgrade the clustered system to a software version that supports the model type of the new node.
2. Record the node serial number, the WWNN, all WWPNNs, and the I/O group to which the node has been added. You might need to use this information later. Having it available can prevent possible data corruption if the node must be removed from and re-added to the clustered system.

#### **Other considerations when you add a node to a clustered system:**

When you add a node to the clustered system using the `addnode` command or the clustered system GUI, you must confirm whether the node has previously been a member of the clustered system. If it has, follow one of these two procedures:

- Add the node to the same I/O group that it was previously in. You can determine the WWNN of the nodes in the clustered system using the `lsnode` command.
- If you cannot determine the WWNN of the nodes in the cluster, call the support team to add the node back into the clustered system without corrupting the data.

When a node is added to a clustered system, it displays a state of adding. It can take as long as 30 minutes for the node to be added to the cluster, particularly if the software version of the node has changed.

**Attention:** If the node remains in the adding state for more than 30 minutes, contact your support representative to assist you in resolving this issue.

When a node is deleted, its name is retained in an I/O group as the failover name of its partner node. If no nodes remain in an I/O group, no failover names are retained. The **addnode** command fails if you specify a name that is either an existing node name or a retained failover name. Specify a different name for the node being added.

### An invocation example

```
addnode -wwnodename 5005076801e08b -iogrp io_grp0
```

### The resulting output

```
Node, id [6], successfully added
```

---

## cfgportip

The **cfgportip** command assigns an IP address to each node ethernet port for iSCSI I/O.

### Syntax

```
►►► cfgportip — -node [node_name | node_id] [-ip [ipv4addr | -ip_6 [ipv6addr]]] [-gw [ipv4gw | -gw_6 [ipv6gw]]]
| ► [-mask [subnet_mask | -prefix_6 [prefix]]] [-failover] [-mtu [mtu | defaultmtu]] [-iogrp [io_grp]]
► -port_id
```

### Parameters

**-node** *node\_name* | *node\_id*

(Required) Specifies which node has the ethernet port that the IP address is being assigned to.

**-ip** *ipv4addr*

(Required if you do not use **ip\_6**) Sets the IPv4 address for the ethernet port. You cannot use this parameter with the **ip\_6** parameter.

**-ip\_6** *ipv6addr*

(Required if you do not use **ip**) Sets the IPv6 address for the ethernet port. You cannot use this parameter with the **ip** parameter.

**-gw** *ipv4addr*

(Required if you do not use **gw\_6**) Sets the IPv4 gateway IP address. You cannot use this parameter with the **gw\_6** parameter.

**-gw\_6** *ipv6gw*

(Required if you do not use **gw**) Sets the IPv6 default gateway address for the port. You cannot use this parameter with the **gw** parameter.

**-mask** *subnet\_mask*

(Required if you do not use **prefix\_6**) Sets the IPv4 subnet mask. You cannot use this parameter with the **prefix\_6** parameter.

**-prefix\_6** *prefix*

(Required if you do not use **mask**) Sets the IPv6 prefix. You cannot use this parameter with the **mask** parameter.



**-failover**

| (Optional) Specifies that the IP address belongs to the partner node in the I/O group. If the partner  
 | node is not configured or offline, the address is configured and presented by this node. When  
 | another node comes online in the I/O group, the failover address is presented by that node.  
 |  
 | If the partner node is online, do not use this option.

| **-mtu** *mtu* | *defaultmtu*

| (Optional) Specifies the maximum transmission unit (MTU). The default is 1500, with a maximum of  
 | 9000. An MTU of 9000 enables you to save CPU utilization for packets of 4 K and over in size. The  
 | increased MTU provides you with improved iSCSI performance.

**-iogrp** *io\_grp*

(Optional) The name of the I/O group on the host.

*port\_id*

| (Required) Specifies which port (1, 2, 3, or 4) to apply changes to.

**Description**

This command assigns either an IPv4 or IPv6 address to a specified ethernet port of a node. The IP address is used for iSCSI I/O. Use the **chclusterip** command to assign cluster IP addresses.

For an IPv4 address, the **ip**, **mask**, and **gw** parameters are required. All of the IPv4 IP parameters must be specified to assign an IPv4 address to an ethernet port.

For an IPv6 address, the **ip\_6**, **prefix\_6**, and **gw\_6** parameters are required. All of the IPv6 IP parameters must be specified to assign an IPv6 address to an ethernet port.

Use the **lspointip** command with the optional **ethernet\_port\_id** parameter to list the port IP addresses for the specified port.

**An invocation example for IPv4**

```
cfgportip -node 1 -ip 9.8.7.1 -gw 9.0.0.1 -mask 255.255.255.0 1
```

**The resulting output**

No feedback

**An invocation example for IPv6**

```
cfgportip -node 1 -ip_6 3:3:0:4::0 -gw_6 ffe8::0 -prefix_6 64 2
```

**The resulting output**

No feedback

**An invocation example to set an MTU of 1600 on port #1 in I/O group 0**

```
cfgportip -mtu 1600 -iogrp 0 1
```

**An invocation example to set the MTU to its default value**

```
cfgportip -defaultmtu -iogrp 0 1
```

---

**chcluster**

The **chcluster** command modifies the attributes of an existing clustered system. You can enter this command any time after a clustered system has been created. All the parameters that are associated with this command are optional. However, you must specify one or more parameters with this command.

## Syntax

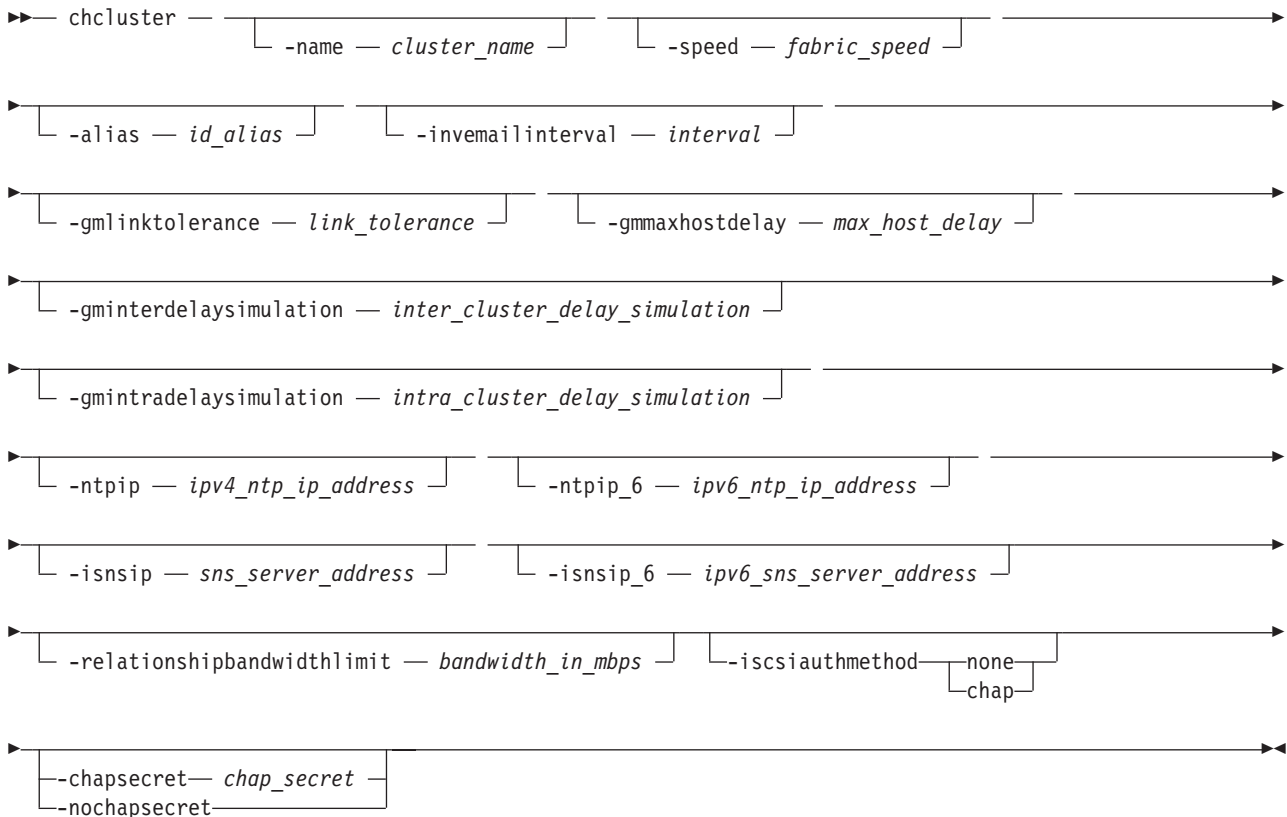

## Parameters

**-name** *cluster\_name*

(Optional) Specifies a new name for the clustered system.

**Important:** The iSCSI Qualified Name (IQN) for each node is generated using the clustered system and node names. If you are using the iSCSI protocol, changing either name also changes the IQN of all of the nodes in the clustered system and might require reconfiguration of all iSCSI-attached hosts.

**-speed** *fabric\_speed*

(Optional) Specifies the speed of the fabric to which this clustered system is attached. Valid values are 1 or 2 (GB).

**Attention:** Changing the speed on a running clustered system breaks I/O service to the attached hosts. Before changing the fabric speed, stop I/O from active hosts and force these hosts to flush any cached data by unmounting volumes (for UNIX host types) or by removing drive letters (for Windows host types). Some hosts might need to be rebooted to detect the new fabric speed.

**-alias** *id\_alias*

(Optional) Specifies an alternate name that does not change the basic ID for the clustered system, but does influence the VDisk\_UID of every **vdiskhostmap**, both existing and new. These objects appear to have been created for a clustered system whose ID matches the alias. Therefore, changing the clustered system alias causes loss of host volume access, until each host rescans for volumes presented by the clustered system.

**-invemailinterval** *interval*

(Optional) Specifies the interval at which inventory emails are sent to the designated email recipients. The interval range is 0 to 15. The interval is measured in days. Setting the value to 0 turns the inventory email notification function off.

**-gminktolerance** *link\_tolerance*

(Optional) Specifies the length of time, in seconds, for which an inadequate intercluster link is tolerated for a Global Mirror operation. The parameter accepts values from 10 to 400 seconds in steps of 10 seconds. The default is 300 seconds. You can disable the link tolerance by entering a value of zero (0) for this parameter.

**-gmmaxhostdelay** *max\_host\_delay*

(Optional) Specifies the maximum time delay, in milliseconds, above which the Global Mirror link tolerance timer starts counting down. This threshold value determines the additional impact that Global Mirror operations can add to the response times of the Global Mirror source volumes. You can use this parameter to increase the threshold from the default value of 5 milliseconds.

**-gminterdelaysimulation** *inter\_cluster\_delay\_simulation*

(Optional) Specifies the intercluster delay simulation, which simulates the Global Mirror round trip delay between two clusters, in milliseconds. The default is 0; the valid range is 0 to 100 milliseconds.

**-gmintradelaysimulation** *intra\_cluster\_delay\_simulation*

(Optional) Specifies the intracluster delay simulation, which simulates the Global Mirror round trip delay in milliseconds. The default is 0; the valid range is 0 to 100 milliseconds.

**-ntpip** *ipv4\_ntp\_ip\_address*

(Optional) Specifies the IPv4 address for the Network Time Protocol (NTP) server. Configuring an NTP server address causes the clustered system to immediately start using that NTP server as its time source. To stop using the NTP server as a time source, invoke the **-ntpip** parameter with a zero address, as follows:

```
chcluster -ntpip 0.0.0.0
```

**-ntpip\_6** *ipv6\_ntp\_ip\_address*

**Note:** An IPv6 prefix and gateway must be set for the clustered system before running this command.

(Optional) Specifies the IPv6 address for the NTP server. Configuring an NTP server address causes the clustered system to immediately start using that NTP server as its time source. To stop using the NTP server as a time source, invoke the **-ntpip\_6** parameter with a zero address, as follows:

```
chcluster -ntpip_6 0::0
```

**-isnsip** *sns\_server\_address*

(Optional) Specifies the IPv4 address for the iSCSI storage name service (SNS). To stop using the configured IPv4 iSCSI SNS server, invoke the **-isnsip** parameter with a zero address, as follows:

```
chcluster -isnsip 0.0.0.0
```

**-isnsip\_6** *ipv6\_sns\_server\_address*

(Optional) Specifies the IPv6 address for the iSCSI SNS. To stop using the configured IPv6 iSCSI SNS server, invoke the **-isnsip\_6** parameter with a zero address, as follows:

```
chcluster -isnsip_6 0::0
```

**-relationshipbandwidthlimit** *bandwidth\_in\_mbps*

(Optional) Specifies the new background copy bandwidth in megabytes per second (MBps), from 1 - 1000. The default is 25 MBps. This parameter operates clustered system-wide and defines the maximum background copy bandwidth that any relationship can adopt. The existing background copy bandwidth settings defined on a partnership continue to operate, with the lower of the partnership and volume rates attempted.

**Note:** Do not set this value higher than the default without establishing that the higher bandwidth can be sustained.

**-iscsiauthmethod none | chap**

(Optional) Sets the authentication method for the iSCSI communications of the clustered system. The **iscsiauthmethod** value can be none or chap.

**-chapsecret chap\_secret**

(Optional) Sets the Challenge Handshake Authentication Protocol (CHAP) secret to be used to authenticate the clustered system via iSCSI. This parameter is required if the **iscsiauthmethod chap** parameter is specified. The specified CHAP secret cannot begin or end with a space.

**-nochapsecret**

(Optional) Clears any previously set CHAP secret for iSCSI authentication. This parameter is not allowed if the **chapsecret** parameter is specified.

## Description

This command modifies specific features of a clustered system. Multiple features can be changed by issuing a single command.

Using the **-ntpip** or **-ntpip\_6** parameter allows the clustered system to use an NTP server as an outside time source. The clustered system adjusts the system clock of the configuration node according to time values from the NTP server. The clocks of the other nodes are updated from the configuration node's clock. In the NTP mode, the **setclustertime** command is disabled.

All command parameters are optional; however, you must specify at least one parameter.

Use the **chclusterip** command to modify the clustered system IP address and service IP address.

### An invocation example

```
chcluster -ntpip 9.20.165.16
```

### The resulting output

No feedback

---

## chclusterip

The **chclusterip** command modifies the IP configuration parameters for the clustered system.

### Syntax

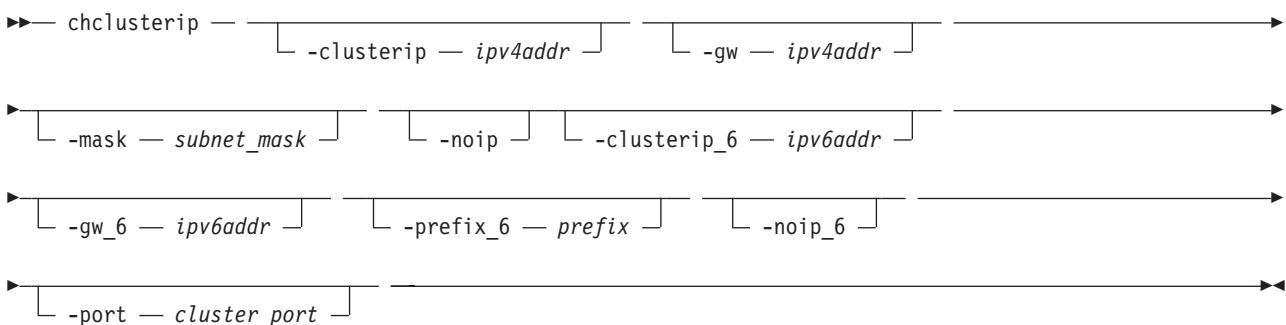

### Parameters

**-clusterip ipv4addr**

(Optional) Changes the IPv4 clustered system IP address. When you specify a new IP address for a clustered system, the existing communication with the clustered system is broken.

- gw** *ipv4addr*  
(Optional) Changes the IPv4 default gateway IP address of the clustered system.
- mask** *subnet\_mask*  
(Optional) Changes the IPv4 subnet mask of the clustered system.
- noip**  
(Optional) Unconfigures the IPv4 stack on the specified port, or both ports if none is specified.  
  
**Note:** This parameter does not affect node service address configurations.
- clusterip\_6** *ipv6addr*  
(Optional) Sets the IPv6 clustered system address for the port.
- gw\_6** *ipv6addr*  
(Optional) Sets the IPv6 default gateway address for the port.
- prefix\_6** *prefix*  
(Optional) Sets the IPv6 prefix.
- noip\_6**  
(Optional) Unconfigures the IPv6 stack on the specified port, or both ports if none is specified.  
  
**Note:** This parameter does not affect node service address configurations.
- port** *cluster\_port*  
(Optional) Specifies which port (1 or 2) to apply changes to. This parameter is required unless the **noip** or **noip\_6** parameter is used.

## Description

This command modifies IP configuration parameters for the clustered system. The first time you configure a second port, all IP information is required. Port 1 on the clustered system must always have one stack fully configured.

There are two active clustered system ports on the configuration node. There are also two active service ports on any node in which you are performing a service action.

If the clustered system IP address is changed, the open command-line shell closes during the processing of the command. You must reconnect to the new IP address if connected through that port.

The **noip** and **noip\_6** parameters can be specified together only if the **port** is also specified. The **noip** and **noip\_6** parameters cannot be specified with any parameters other than **port**.

**Note:** The **noip** and **noip\_6** parameters do not affect node service address configurations. Port 1 must have an IPv4 or IPv6 clustered system address. The configuration of port 2 is optional.

Service IP addresses for all ports and stacks are initialized to DHCP. A service IP address is always configured.

**Modifying an IP address:** List the IP address of the clustered system by issuing the **lscluster** command. Modify the IP address by issuing the **chclusterip** command. You can either specify a static IP address or have the system assign a dynamic IP address.

Table 18 provides IP address formats that are supported.

Table 18. *ip\_address\_list* formats

| IP type | <i>ip_address_list</i> format |
|---------|-------------------------------|
| IPv4    | 1.2.3.4                       |

Table 18. *ip\_address\_list* formats (continued)

| IP type              | <i>ip_address_list</i> format           |
|----------------------|-----------------------------------------|
| Full IPv6            | 1234:1234:abcd:0123:0000:0000:7689:6576 |
| Zero-compressed IPv6 | 1234:1234:abcd:123::7689:6576           |

### An invocation example

```
chclusterip -clusterip 9.20.136.5 -gw 9.20.136.1 -mask 255.255.255.0 -port 1
```

### The resulting output

No feedback

## chiogrp

The **chiogrp** command modifies the name of an I/O group, or the amount of memory that is available for Copy Services or VDisk mirroring operations.

### Syntax

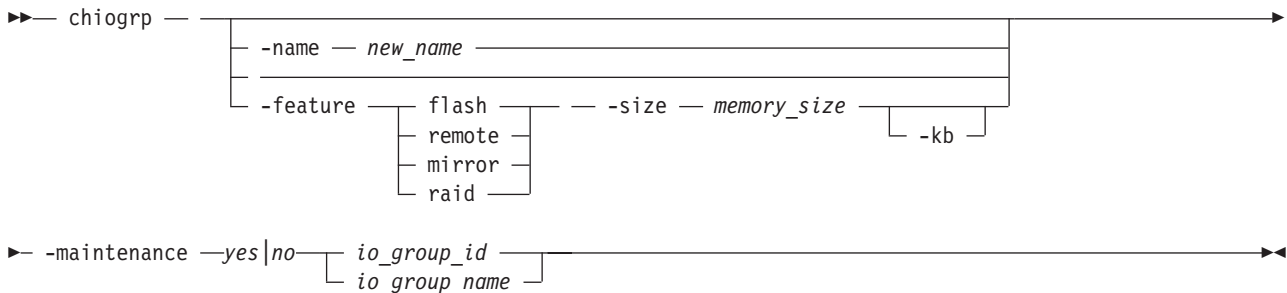

### Parameters

#### **-name** *new\_name*

(Optional) Specifies the name to assign to the I/O group. The **-name** parameter cannot be specified with the **-feature**, **-size**, or **-kb** parameters.

#### **-feature** **flash** | **remote** | **mirror** | **raid**

(Optional) Specifies the feature to modify the amount of memory for: Copy Services or VDisk mirroring. You must specify this parameter with the **-size** parameter. You cannot specify this parameter with the **-name** parameter.

**Note:** Specifying **remote** changes the amount of memory that is available for Metro Mirror or Global Mirror processing. Any VDisk that is in a Metro Mirror or Global Mirror relationship uses memory in its I/O group, including master and auxiliary VDIsks, and VDIsks that are in inter-cluster or intra-cluster relationships.

#### **-size** *memory\_size*

(Optional) Specifies the amount of memory that is available for the specified Copy Services or VDisk mirroring function. Valid input is **0** or any integer. The default unit of measurement for this parameter is megabytes (MB); you can use the kilobytes **-kb** parameter to override the default. You must specify this parameter with the **-feature** parameter. You cannot specify this parameter with the **-name** parameter.

#### **-kb**

(Optional) Changes the units for the **-size** parameter from megabytes (MB) to kilobytes (KB). If you

specify this parameter, the **-size** *memory\_size* value must be any number divisible by 4. You must specify this parameter with the **-feature** and **-size** parameters. You cannot specify this parameter with the **-name** parameter.

*io\_group\_id* | *io\_group\_name*

(Required) Specifies the I/O group to modify. You can modify an I/O group by using the **-name** or the **-feature** parameter.

**-maintenance** *yes|no*

(Optional) Specifies whether the I/O group should be in maintenance mode. The I/O group should be placed in maintenance mode while carrying out service procedures on storage enclosures. Once you enter maintenance mode, it continues until either:

- It is explicitly cleared, OR
- 30 minutes elapse

**Note:** Changing the maintenance mode on any I/O group changes the maintenance mode on all I/O groups.

## Description

The **chiogrp** command modifies the name of an I/O group or the amount of memory that is available for Copy Services or VDisk mirroring. You can assign a name to an I/O group or change the name of a specified I/O group. You can change the amount of memory that is available for Copy Services or VDisk mirroring operations by specifying the **-feature flash | remote | mirror** parameter, and a memory size. For VDisk mirroring and Copy Services (FlashCopy, Metro Mirror, and Global Mirror), memory is traded against memory that is available to the cache. The amount of memory can be decreased or increased. Consider the following memory sizes when you use this command:

- The default memory size for FlashCopy is 20 MB.
- The default memory size for Metro Mirror and Global Mirror is 20 MB.
- The default memory size for mirrored VDIs is 20 MB.
- The maximum memory size that can be specified for FlashCopy is 512 MB.
- The maximum memory size that can be specified for Metro Mirror and Global Mirror is 512 MB.
- The maximum memory size that can be specified for mirrored VDIs is 512 MB.
- The maximum combined memory size across all features is 552 MB.

Table 19 demonstrates the amount of memory required for VDisk mirroring and Copy Services. Each 1 MB of memory provides the following VDisk capacities and grain sizes:

*Table 19. Memory required for VDisk Mirroring and Copy Services*

| Feature                        | Grain size | 1 MB of memory provides the following VDisk capacity for the specified I/O group |
|--------------------------------|------------|----------------------------------------------------------------------------------|
| Metro Mirror and Global Mirror | 256 KB     | 2 TB of total Metro Mirror and Global Mirror VDisk capacity                      |
| FlashCopy                      | 256 KB     | 2 TB of total FlashCopy source VDisk capacity                                    |
| FlashCopy                      | 64 KB      | 512 GB of total FlashCopy source VDisk capacity                                  |
| Incremental FlashCopy          | 256 KB     | 1 TB of total Incremental FlashCopy source VDisk capacity                        |
| Incremental FlashCopy          | 64 KB      | 256 GB of total Incremental FlashCopy source VDisk capacity                      |
| VDisk mirroring                | 256 KB     | 2 TB of mirrored VDIs                                                            |

Table 20 provides an example of RAID level comparisons with their bitmap memory cost, where *MS* is the size of the member drives and *MC* is the number of member drives.

Table 20. RAID level comparisons

| Level   | Member count | Approximate capacity  | Redundancy | Approximate bitmap memory cost                                                     |
|---------|--------------|-----------------------|------------|------------------------------------------------------------------------------------|
| RAID-0  | 1-8          | MC * MS               | None       | (1 MB per 2 TB of MS) * MC                                                         |
| RAID-1  | 2            | MS                    | 1          | (1 MB per 2 TB of MS) * (MC/2)                                                     |
| RAID-5  | 3-16         | (MC-1) * MS           | 1          | 1 MB per 2 TB of MS with a strip size of 256 KB; double with strip size of 128 KB. |
| RAID-6  | 5-16         | less than (MC-2 * MS) | 2          |                                                                                    |
| RAID-10 | 2-16 (evens) | MC/2 * MS             | 1          | (1 MB per 2 TB of MS) * (MC/2)                                                     |

**Note:** There is a margin of error on the approximate bitmap memory cost of approximately 15%. For example, the cost for a 256 KB RAID-5 is ~1.15 MB for the first 2 TB of MS.

For multiple FlashCopy targets, you must consider the number of mappings. For example, for a mapping with a 256 KB grain size, 8 KB of memory allows one mapping between a 16 GB source VDisk and a 16 GB target VDisk. Alternatively, for a mapping with a 256 KB grain size, 8 KB of memory allows two mappings between one 8 GB source VDisk and two 8 GB target VDIs.

When you create a FlashCopy mapping, if you specify an I/O group other than the I/O group of the source VDisk, the memory accounting goes towards the specified I/O group, not towards the I/O group of the source VDisk.

### An invocation example

```
chiogrp -name testiogrpone io_grp0
```

### The resulting output

No feedback

### An invocation example for changing the amount of FlashCopy memory in io\_grp0 to 30 MB

```
chiogrp -feature flash -size 30 io_grp0
```

### The resulting output

No feedback

---

## chnode

You can use the **chnode** command to change the name that is assigned to a node and other options. The name can then be used when running subsequent commands. All the parameters that are associated with this command are optional. However, you must specify one or more parameters with this command.

### Syntax

```

>> chnode — [-iscsialias — alias] [-failover] [-name — new_node_name]
 [-noiscsialias]

```



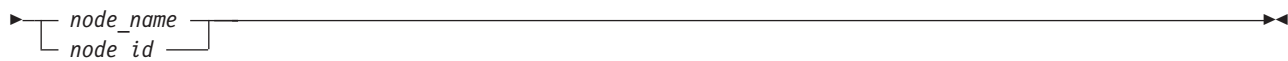

## Parameters

### **-iscsialias** *alias*

(Optional) Specifies the iSCSI name of the node. The maximum length is 79 characters.

### **-noiscsialias**

(Optional) Clears any previously set iSCSI name for this node. This parameter cannot be specified with the **iscsialias** parameter.

### **-failover**

(Optional) Specifies that the name or iSCSI alias being set is the name or alias of the partner node in the I/O group. When there is no partner node, the values set are applied to the partner node when it is added to the cluster. If this parameter is used when there is a partner node, the name or alias of that node changes.

### **-name** *new\_node\_name*

(Optional) Specifies the name to assign to the node.

**Note:** Node names supplied with **-name** on **addnode** and **chnode** must not already be in use as node names or as node failover\_names.

**Important:** The iSCSI Qualified Name (IQN) for each node is generated using the cluster and node names. If you are using the iSCSI protocol, changing either name also changes the IQN of all of the nodes in the cluster and might require reconfiguration of all iSCSI-attached hosts.

### *node\_name* | *node\_id*

(Required) Specifies the node to be modified. The variable that follows the parameter is either:

- The node name that you assigned when you added the node to the cluster.
- The node ID that is assigned to the node (not the worldwide node name).

## Description

If the **failover** parameter is not specified, this command changes the name or iSCSI alias of the node. The name can then be used to identify the node in subsequent commands.

The **failover** parameter is used to specify values that are normally applied to the partner node in the I/O group. When the partner node is offline, the iSCSI alias and IQN are assigned to the remaining node in the I/O Group. The iSCSI host data access is then preserved. If the partner node is offline when these parameters are set, the node they are set on handles iSCSI I/O requests to the iSCSI alias specified, or the IQN that is created using the node name. If the partner node in the I/O group is online when these parameters are set, the partner node handles iSCSI requests to the iSCSI alias specified, and its node name and IQN change.

### An invocation example

```
chnode -name testnodeone nodeone
```

### The resulting output

No feedback

---

## chnodehw

The **chnodehw** command updates the hardware configuration for a node.

## Syntax

```
▶▶ chnodehw [-force] -- node_id_or_name
```

## Parameters

### -force

(Optional) Skips the node dependent checks. This might cause I/O outages.

### node\_id\_or\_name

The node ID or node name.

## Description

This command automatically reboots the node if the node hardware is different than its configured hardware. After rebooting, the node begins to use its hardware, and does not use the previous configuration.

### An invocation example of how to update the node hardware configuration of node ID 7

```
chnodehw 7
```

### An invocation example of how to update the node hardware configuration for node7 (even if the reboot of the node causes an I/O outage):

```
chnodehw -force node7
```

---

## cleardumps

The **cleardumps** command cleans the various dump directories on a specified node.

## Syntax

```
▶▶ cleardumps -- -prefix -- directory_or_file_filter [node_id | node_name]
```

## Parameters

### -prefix directory\_or\_file\_filter

(Required) Specifies the directory, files, or both to be cleaned. If a directory is specified, with no file filter, all relevant dump or log files in that directory are cleaned. You can use the following directory arguments (filters):

- **/dumps** (cleans all files in all subdirectories)
- **/dumps/cimom**
- **/dumps/configs**
- **/dumps/elogs**
- **/dumps/feature**
- **/dumps/iostats**
- **/dumps/iotrace**
- **/dumps/mdisk**
- **/home/admin/upgrade**

In addition to the directory, you can specify a filter file. For example, if you specify `/dumps/elogs/*.txt`, all files in the `/dumps/elogs` directory that end in `.txt` are cleaned.

**Note:** The following rules apply to the use of wildcards with the SAN Volume Controller CLI:

- The wildcard character is an asterisk (\*).
- The command can contain a maximum of one wildcard.
- With a wildcard, you must use double quotation marks (" ") around the filter entry, such as in the following entry:

```
>cleardumps -prefix "/dumps/elogs/*.txt"
```

`node_id` | `node_name`

(Optional) Specifies the node to be cleaned. The variable that follows the parameter is either:

- The node name, that is, the label that you assigned when you added the node to the cluster
- The node ID that is assigned to the node (not the worldwide node name).

## Description

This command deletes all the files that match the `directory/file_filter` argument on the specified node. If no node is specified, the configuration node is cleaned.

You can clean all the dumps directories by specifying `/dumps` as the directory variable.

You can clean all the files in a single directory by specifying one of the directory variables.

You can list the contents of these directories on the given node by using the `lsxxxxdumps` commands.

You can use this command to clean specific files in a given directory by specifying a directory or file name. You can use the wildcard character as part of the file name.

**Note:** To preserve the configuration and trace files, any files that match the following wildcard patterns are not cleaned:

- `*svc.config*`
- `*.trc`
- `*.trc.old`

### An invocation example

```
cleardumps -prefix /dumps/configs
```

### The resulting output

No feedback

---

## cpdumps

The `cpdumps` command copies dump files from a nonconfiguration node onto the configuration node.

**Note:** In the rare event that the `/dumps` directory on the configuration node is full, the copy action ends when the directory is full and provides no indicator of a failure. Therefore, clear the `/dumps` directory after migrating data from the configuration node.

## Syntax

```
▶▶▶ cpdumps — — -prefix — [directory] — [node_name] —▶▶▶
 [file_filter] [node_id]
```

## Parameters

**-prefix** *directory* | *file\_filter*

(Required) Specifies the directory, or files, or both to be retrieved. If a directory is specified with no file filter, all relevant dump or log files in that directory are retrieved. You can use the following directory arguments (filters):

- **/dumps** (retrieves all files in all subdirectories)
- **/dumps/audit**
- **/dumps/cimom**
- **/dumps/configs**
- **/dumps/elogs**
- **/dumps/feature**
- **/dumps/iostats**
- **/dumps/iotrace**
- **/dumps/mdisk**
- **/home/admin/upgrade**
- **(Storwize V7000) /dumps/enclosure**

In addition to the directory, you can specify a file filter. For example, if you specified `/dumps/elogs/*.txt`, all files in the **/dumps/elogs** directory that end in `.txt` are copied.

**Note:** The following rules apply to the use of wildcards with the CLI:

- The wildcard character is an asterisk (\*).
- The command can contain a maximum of one wildcard.
- When you use a wildcard, you must surround the filter entry with double quotation marks (""), as follows:

```
>cleardumps -prefix "/dumps/elogs/*.txt"
```

**node\_id** | **node\_name**

(Required) Specifies the node from which to retrieve the dumps. The variable that follows the parameter can be one of the following:

- The node name, or label that you assigned when you added the node to the cluster
- The node ID that is assigned to the node (not the worldwide node name).

If the node specified is the current configuration node, no file is copied.

## Description

This command copies any dumps that match the directory or file criteria from the given node to the current configuration node.

You can retrieve dumps that were saved to an old configuration node. During failover processing from the old configuration node to another node, the dumps that were on the old configuration node are not automatically copied. Because access from the CLI is only provided to the configuration node, cluster files can only be copied from the configuration node. This command enables you to retrieve files and place them on the configuration node so that you can then copy them.

You can view the contents of the directories by using the **lsxxxxdumps** commands.

### An invocation example

```
cpdumps -prefix /dumps/configs nodeone
```

### The resulting output

---

## detectmdisk

Use the **detectmdisk** command to manually rescan the Fibre Channel network for any new managed disks (MDisks) that might have been added, and to rebalance MDisk access across all available controller device ports.

### Syntax

►► — detectmdisk ————— ◄◄

### Description

This command causes the clustered system (system) to rescan the Fibre Channel network. The rescan discovers any new MDisks that have been added to the system and rebalances MDisk access across the available controller device ports. This command also detects any loss of controller port availability, and updates the SAN Volume Controller configuration to reflect any changes.

**Note:** Although it might appear that the **detectmdisk** command has completed, some extra time might be required for it to run. The **detectmdisk** is asynchronous and returns a prompt while the command continues to run in the background. You can use the **lsdiscoverystatus** command to list the discovery status.

In general, the system automatically detects disks when they appear on the network. However, some Fibre Channel controllers do not send the required SCSI primitives that are necessary to automatically discover the new disks.

If you have attached new storage and the system has not detected it, you might need to run this command before the system detects the new disks.

When back-end controllers are added to the Fibre Channel SAN and are included in the same switch zone as a system, the system automatically discovers the back-end controller and determines what storage is presented to it. The SCSI LUs that are presented by the back-end controller are displayed as unmanaged MDisks. However, if the configuration of the back-end controller is modified after this has occurred, the system might be unaware of these configuration changes. Run this command to rescan the Fibre Channel network and update the list of unmanaged MDisks.

**Note:** The automatic discovery that is performed by the system does not write to an unmanaged MDisk. Only when you add an MDisk to a storage pool, or use an MDisk to create an image mode virtual disk, is the storage actually used.

To identify the available MDisks, issue the **detectmdisk** command to scan the Fibre Channel network for any MDisks. When the detection is complete, issue the **lsmdiskcandidate** command to show the unmanaged MDisks; these MDisks have not been assigned to a storage pool. Alternatively, you can issue the **lsmdisk** command to view all of the MDisks.

If disk controller ports have been removed as part of a reconfiguration, the SAN Volume Controller detects this change and reports the following error because it cannot distinguish an intentional reconfiguration from a port failure:

```
1630 Number of device logins reduced
```

If the error persists and redundancy has been compromised, the following more serious error is reported:

```
1627 Insufficient redundancy in disk controller connectivity
```

You must issue the **detectmdisk** command to force SAN Volume Controller to update its configuration and accept the changes to the controller ports.

**Note:** Only issue the **detectmdisk** command when all of the disk controller ports are working and correctly configured in the controller and the SAN zoning. Failure to do this could result in errors not being reported.

#### An invocation example

```
detectmdisk
```

#### The resulting output

```
No feedback
```

---

## ping

The **ping** command can be used to diagnose IP configuration problems by checking whether the specified IP address is accessible from the configuration node.

### Syntax

```
▶▶ ping [ipv4_address | ipv6_address] ▶▶
```

### Parameters

*ipv4\_address* | *ipv6\_address*  
(Required) Specifies the clustered system IP address.

### Description

This command checks whether the specified IP address is accessible from the configuration node.

- | **Note:** You can only use this command on ports 1 and 2 (for management traffic). The ping takes place only from the configuration node. It can be useful for diagnosing problems where the configuration node cannot be reached from a specific management server.

#### An invocation example

```
ping 9.20.136.11
```

#### The resulting output

```
PING 9.20.136.11 (9.20.136.11) 56(84) bytes of data.
64 bytes from 9.20.136.11: icmp_seq=1 ttl=249 time=0.690 ms
64 bytes from 9.20.136.11: icmp_seq=2 ttl=249 time=0.382 ms
64 bytes from 9.20.136.11: icmp_seq=3 ttl=249 time=0.311 ms
--- 9.20.136.11 ping statistics ---
3 packets transmitted, 3 received, 0% packet loss, time 2001ms
rtt min/avg/max/mdev = 0.311/0.461/0.690/0.164 ms
```

---

## rmnode

The **rmnode** command deletes a node from the cluster. You can enter this command any time after a cluster has been created.

## Syntax

```
rmnode [-force] [node_name | node_id]
```

## Parameters

### -force

(Optional) Overrides the checks that this command runs. The parameter overrides the following two checks:

- If the command results in VDIsks going offline, the command fails unless the **force** parameter is used.
- If the command results in a loss of data because there is unwritten data in the write cache that is contained only within the node to be removed, the command fails unless the **force** parameter is used.

If you use the **force** parameter as a result of an error about VDIsks going offline, you force the node removal and run the risk of losing data from the write cache. The **force** parameter should always be used with caution.

*node\_name* | *node\_id*

Specifies the node to be deleted. The value for this parameter can be one of the following:

- The node name that you assigned when you added the node to the cluster
- The node ID that is assigned to the node (not the worldwide node name).

## Description

This command removes a node from the cluster. This makes the node a candidate to be added back into this cluster or into another cluster. After the node is deleted, the other node in the I/O group enters write-through mode until another node is added back into the I/O group.

By default, the **rmnode** command flushes the cache on the specified node before the node is taken offline. In some circumstances, such as when the system is already degraded (for example, when both nodes in the I/O group are online and the virtual disks within the I/O group are degraded), the system ensures that data loss does not occur as a result of deleting the only node with the cache data.

The cache is flushed before the node is deleted to prevent data loss if a failure occurs on the other node in the I/O group.

To take the specified node offline immediately without flushing the cache or ensuring data loss does not occur, run the **rmnode** command with the **-force** parameter.

### Prerequisites:

Before you issue the **rmnode** command, perform the following tasks and read the following Attention notices to avoid losing access to data:

1. Determine which virtual disks (VDIsks) are still assigned to this I/O group by issuing the following command. The command requests a filtered view of the VDIsks, where the filter attribute is the I/O group.

```
lsvdisk -filtervalue IO_group_name=name
```

where *name* is the name of the I/O group.

**Note:** Any VDIsks that are assigned to the I/O group that this node belongs to are assigned to the other node in the I/O group; the preferred node is changed. You cannot change this setting back.

2. Determine the hosts that the VDisks are mapped to by issuing the **lsvdiskhostmap** command.
3. Determine if any of the VDisks that are assigned to this I/O group contain data that you need to access:
  - If you *do not* want to maintain access to these VDisks, go to step 5.
  - If you *do* want to maintain access to some or all of the VDisks, back up the data or migrate the data to a different (online) I/O group.
4. Determine if you need to turn the power off to the node:
  - If this is the last node in the cluster, you do not need to turn the power off to the node. Go to step 5.
  - If this is *not* the last node in the cluster, turn the power off to the node that you intend to remove. This step ensures that the Subsystem Device Driver (SDD) does not rediscover the paths that are manually removed before you issue the delete node request.
5. Update the SDD configuration for each virtual path (vpath) that is presented by the VDisks that you intend to remove. Updating the SDD configuration removes the vpaths from the VDisks. Failure to update the configuration can result in data corruption. See the *Multipath Subsystem Device Driver: User's Guide* for details about how to dynamically reconfigure SDD for the given host operating system.
6. Quiesce all I/O operations that are destined for the node that you are deleting. Failure to quiesce the operations can result in failed I/O operations being reported to your host operating systems.

#### Attention:

1. Removing the last node in the cluster destroys the cluster. Before you delete the last node in the cluster, ensure that you want to destroy the cluster.
2. If you are removing a single node and the remaining node in the I/O group is online, the data can be exposed to a single point of failure if the remaining node fails.
3. This command might take some time to complete since the cache in the I/O group for that node is flushed before the node is removed. If the **-force** parameter is used, the cache is not flushed and the command completes more quickly. However, if the deleted node is the last node in the I/O group, using the **-force** option results in the write cache for that node being discarded rather than flushed, and data loss can occur. The **-force** option should be used with caution.
4. If both nodes in the I/O group are online and the VDisks are already degraded before deleting the node, redundancy to the VDisks is already degraded and loss of access to data and loss of data might occur if the **-force** option is used.

#### Notes:

1. If you are removing the configuration node, the **rmnode** command causes the configuration node to move to a different node within the cluster. This process might take a short time: typically less than a minute. The cluster IP address remains unchanged, but any SSH client attached to the configuration node might need to reestablish a connection. The management GUI reattaches to the new configuration node transparently.
2. If this is the last node in the cluster or if it is currently assigned as the configuration node, all connections to the cluster are lost. The user interface and any open CLI sessions are lost if the last node in the cluster is deleted. A time-out might occur if a command cannot be completed before the node is deleted.

#### An invocation example

```
rmnode 1
```

#### The resulting output

```
No feedback
```



---

## rmportip

The **rmportip** command removes an iSCSI IP address from a node ethernet port.

### Syntax

```
rmportip [-failover] [-ip_6] -node node_name | node_id --port_id--
|
| [-mtu mtu | defaultmtu]
```

### Parameters

#### **-failover**

(Optional) Specifies that the failover IP address information be removed for the specified port.

#### **-ip\_6**

(Optional) Specifies that the IPv6 address be removed for the specified port. If this parameter is not used, the IPv4 address is removed by default.

#### **-node** *node\_name* | *node\_id*

(Required) Specifies the node with the ethernet port that the IP address is being removed from.

#### *port\_id*

(Required) Specifies which port (1, 2, 3, or 4) to apply changes to.

#### **-mtu** *mtu* | *defaultmtu*

(Optional) Specifies the maximum transmission unit (MTU). The default is 1500, with a maximum of 9000. An MTU of 9000 enables you to save CPU utilization for packets of 4 K and over in size. The increased MTU provides you with improved iSCSI performance.

### Description

This command removes an IPv4 or IPv6 address from an ethernet port of a node.

#### An invocation example for IPv4

```
rmportip -node 1 1
```

#### The resulting output

No feedback

#### An invocation example for IPv6

```
rmportip -node 1 -ip_6 2
```

#### The resulting output

No feedback

---

## setclustertime

The **setclustertime** command allows you to set the time for the clustered system (system).

### Syntax

```
setclustertime -- -time -- time_value ----->
```

## Parameters

**-time** *time\_value*

(Required) Specifies the time to which the system must be set. This must be in the following format:

MMDDHHmmYYYY

## Description

This command sets the time for the system.

### An invocation example

```
setclustertime -time 040509142003
```

### The resulting output

No feedback

---

## setpwdreset

Use the **setpwdreset** command to view and change the status of the password-reset feature for the display panel.

## Syntax

```
▶▶ setpwdreset — [-disable | -enable | -show] ▶▶
```

## Parameters

### -disable

Disables the password-reset feature that is available through the front panel menu system.

### -enable

Enables the password-reset feature that is available through the front panel menu system.

### -show

Displays the status of the password-reset feature, which is either enabled or disabled.

## Description

The front panel menu system provides an option to reset the clustered system (system) superuser password. This option resets the password to a random string that is displayed on the front panel. You can then use this password to access the system. You can change the password at the next login.

Issue the **setpwdreset** command to view and change the status of the password-reset feature for the display panel. Passwords can consist of the following characters: A - Z, a - z, 0 - 9, and underscore ( \_ ). Make a careful note of the system superuser password, because without it, you cannot access the system.

This command allows you access in case the system superuser password is forgotten. If you leave this feature enabled, you should ensure adequate physical security to the system hardware.

You can view or change the status of this feature.

### An invocation example

```
setpwdreset -show
```

## The resulting output

Password status: [1]

This output means that the password or reset feature that is available through the front panel menu system is enabled. If the password status is [0], this feature is disabled.

---

## settimezone

Use the **settimezone** command to set the time zone for the cluster.

### Syntax

```
▶▶— settimezone — — -timezone — timezone_arg —————▶▶
```

### Parameters

**-timezone** *timezone\_arg*

Specifies the time zone to set for the cluster.

### Description

This command sets the time zone for the cluster. Use the **-timezone** parameter to specify the numeric ID of the time zone that you want to set. Issue the **lstimezones** command to list the time-zones that are available on the cluster. A list of valid time-zones settings are displayed in a list.

The time zone that this command sets will be used when formatting the error log that is produced by issuing the following command:

```
dumperrlog
```

**Note:** If you have changed the timezone, you must clear the error log dump directory before you can view the error log through the web application.

Issue the **showtimezone** command to display the current time-zone settings for the cluster. The cluster ID and its associated time-zone are displayed. Issue the **setclustertime** command to set the time for the cluster.

### An invocation example

```
settimezone -timezone 5
```

### The resulting output

No feedback

---

## startstats

Use the **startstats** command to modify the interval at which per-node statistics for virtual disks (VDisks), managed disks (MDisks), and nodes are collected.

### Syntax

```
▶▶— startstats — — -interval — time_in_minutes —————▶▶
```

## Parameters

**-interval** *time\_in\_minutes*

Specifies the time in minutes. This is the time interval between the gathering of statistics, from 1 to 60 minutes in increments of 1 minute.

## Description

Running the **startstats** command will reset the statistics timer to zero (0), and give it a new interval at which to sample. Statistics are collected at the end of each sampling period as specified by the **-interval** parameter. These statistics are written to a file, with a new file created at the end of each sampling period. Separate files are created for MDisks, VDisks and node statistics.

The files generated are written to the `/dumps/iostats` directory.

A maximum of 16 files are stored in the directory at any one time for each statistics file type, for example:

```
Nm_stats_nodepanelname_date_time
Nv_stats_nodepanelname_date_time
Nn_stats_nodepanelname_date_time
```

Statistics files are created for all time intervals. Before the 17th file for each type is created, the oldest file of that type is deleted.

These files can be listed by using the **lsiostatsdumps** command.

The following naming convention is used for these files:

```
stats_type_stats_nodepanelname_date_time
```

Where *stats\_type* is Nm for MDisks, Nv for VDisks, and Nn for node statistics. *nodepanelname* is the current configuration node panel name, *date* is in the format of `yymmdd`, and *time* is in the format of `hhmmss`.

The following is an example of an MDisk statistics file name:

```
Nm_stats_000229_031123_072426
```

The following is an example of a VDisk statistics file name:

```
Nv_stats_000229_031123_072426
```

The following is an example of a node statistics file name:

```
Nn_stats_000229_031123_072426
```

Statistics are collected for each MDisk and recorded in the `Nm_stats_nodepanelname_date_time` file, including the following statistical information:

- The number of SCSI read and write commands that are processed during the sample period
- The number of blocks of data that are read and written during the sample period
- Per MDisk, cumulative read and write external response times in milliseconds
- Per MDisk, cumulative read and write queued response times

Statistics are collected for each VDisk and recorded in the `Nv_stats_nodepanelname_date_time` file, including the following statistical information:

- The total number of processed SCSI read and write commands
- The total amount of read and written data

- Cumulative read and write response time in milliseconds
- Statistical information about the read/write cache usage
- Global Mirror statistics including latency

Statistics are collected for the node from which the statistics file originated and recorded in the `Nn_stats_nodepanelname_date_time` file, including the following statistical information:

- Usage figure for the node from which the statistic file was obtained
- The amount of data transferred to and received from each port on the node to other devices on the SAN
- Statistical information about communication to other nodes on the fabric

### An invocation example

```
startstats -interval 25
```

### The resulting output

No feedback

## stopcluster

The **stopcluster** command allows you to shut down a single node or the entire clustered system in a controlled manner. When you issue this command, you are prompted with a confirmation of intent to process the command.

### Syntax

```

>> stopcluster - [-force] [-node node_name | node_id]

```

### Parameters

#### -force

(Optional) Specifies that the node that is being shut down is the last online node in a given I/O group. The **force** parameter also overrides the checks that this command runs. The parameter overrides the following two checks:

- If the command results in volumes going offline, the command fails unless the **force** parameter is used.
- If the node being shut down is the last online node in the I/O group, the command fails unless the **force** parameter is used.

If you use the **force** parameter as a result of an error about volumes going offline, you force the node to shut down, even if it is the last online node in the I/O group. The **force** parameter should always be used with caution.

#### -node node\_name | node\_id

(Optional) Specifies the node that you want to shut down. You can specify one of the following values:

- The node name, or label that you assigned when you added the node to the system.
- The node ID that is assigned to the node (not the worldwide node name).

If you specify **-node node\_name | node\_id**, only the specified node is shut down; otherwise, the entire system is shut down.

## Description

- | If you enter this command with no parameters, the entire system is shut down. All data is flushed to disk before the power is removed.
- | If you enter this command with either a node ID or node name, the specified node is shut down. After the command completes, the remaining node in the I/O group enters write-through mode until the power to the node is returned, and the node rejoins the system.
- | Entering `y` or `Y` to the confirmation message processes the command. No feedback is then displayed.
- | Entering anything other than `y` or `Y` results in the command not processing. No feedback is displayed.
- | If you need to shut down the entire system or a single node, use this command instead of using the power button on the nodes or powering off the main power supplies to the system.
- | **Attention:** Do not power off the uninterruptible power supply or remove the power cable from the node.
- | **Storwize V7000:** If you need to shut down the system or a single node, use this command instead of using the power button on power supplies, or powering off the mains to the system.
- | Before shutting down a node or system, complete the following requirements:
  - | 1. Quiesce all I/O operations that are destined for this node or system. If you do not quiesce these, failed I/O operations might be reported to your host operating systems.
  - | 2. Stop all FlashCopy, Metro Mirror, Global Mirror, and data migration operations.
  - | 3. Ensure that all asynchronous deletion operations have completed.
- | Using this command to shut down a single node fails if shutting down the node makes any volumes inaccessible, or if it is the last node in an I/O group. If you still need to shut down the node, you can use the **-force** option to override these checks.

### An invocation example

```
stopcluster
```

**The resulting output** You will be presented with the following warning:

```
Are you sure that you want to continue with the shut down?
```

---

## stopstats (Deprecated)

The **stopstats** command has been deprecated. You can no longer disable statistics collection.

---

## Chapter 9. Clustered system diagnostic and service-aid commands

Clustered system diagnostic and service-aid commands are designed to diagnose and find clustered system problems.

The SAN Volume Controller enables you to perform service activity, such as problem determination and repair activities, with a limited set of command-line tools. When you are logged in under the administrator role, all command-line activities are permitted. When you are logged in under the service role, only those commands that are required for service are enabled. All of these commands apply under the service role.

---

### applysoftware

The **applysoftware** command upgrades the clustered system (system) to a new level of software.

#### Syntax

```
▶▶ applysoftware — [-file filename_arg] [-abort] [-force] ▶▶
```

#### Parameters

**-file** *filename\_arg*

(Required for performing an upgrade) Specifies the file name of the new software package to be applied.

**-abort**

(Required for stopping an upgrade) Specifies that a stalled upgrade should be stopped, returning the system to the original software level.

**Note:** The **force** parameter can be used with the **abort** parameter. If one or more nodes are offline, you must use the **force** parameter with the **abort** parameter.

**-force**

(Optional) Specifies that the upgrade or abort should proceed even if there are non-redundant nodes in the system.

**Note:** Using this option might result in a loss of access.

#### Description

This command starts the upgrade process of the system to a new level of SAN Volume Controller software. The **applysoftware** command applies a level of software to the node as a service action (Paced Upgrade) to upgrade the specific node, or as an automatic upgrade process that upgrades all of the nodes in the entire system.

The software package as specified by the file name must first be copied onto the current configuration node in the /home/admin/upgrade directory. You can use the PuTTY secure copy (scp) application to copy the file.

The command completes as soon as the upgrade process has successfully begun. The command fails and the upgrade package is deleted if:

- The given package fails an integrity check due to corruption.
- Any node in the system has a hardware type not supported by the new software.
- The new software level does not support upgrades from the currently installed software.
- The software level of a remote system is incompatible with the new software.
- There are any volumes that are dependent on the status of a node.

**Note:** The **force** parameter can be used to override this if you are prepared to lose access to data during the upgrade. Before proceeding, use the **ldependentvdisks** command with the **node** parameter to list the node-dependent volumes at the time the command is run. If the command returns an error, you must move your quorum disks to MDisks that are accessible through all nodes. Rerun the command until no errors are returned.

The actual upgrade completes asynchronously.

The **lsdumps** command allows you to view the contents of the `/home/admin/upgrade` directory.

#### An invocation example

```
applysoftware -file softwareupdate
```

#### The resulting output

No feedback

### caterrlog (Deprecated)

The **caterrlog** command has been deprecated. Use the **lseventlog** command instead.

### caterrlogbyseqnum (Deprecated)

The **caterrlogbyseqnum** command has been deprecated. Use the **lseventlog** command instead.

### cherrstate

The **cherrstate** command marks an unfixed error as fixed. You can also use it to mark a fixed error as unfixed.

#### Syntax

```
▶▶ cherrstate — — -sequencenumber — sequence_number — — -unfix ▶▶
```

#### Parameters

**-sequencenumber** *sequence\_number*

(Required) Specifies the error log sequence numbers to mark as fixed or as unfixed.

**-unfix**

(Optional) Specifies that the sequence numbers be marked as unfixed. Use this parameter when you have marked the wrong sequence number as fixed.

#### Description

The error log entries that the sequence numbers that you entered are marked as fixed. Use this command as a manual confirmation step that you have performed a maintenance procedure on the cluster, the fabric, or the subsystems.



This step is performed as part of the fix procedures.

Optionally, if you have wrongly marked a sequence number as fixed, you can use the **-unfix** parameter to change the entry to unfixed.

#### An invocation example

```
cherrstate -sequencenumber 2019
```

#### The resulting output

No feedback

---

## clearerrlog

The **clearerrlog** command clears all entries from the error log including status events and any unfixed errors.

### Syntax

```
▶▶ clearerrlog — [-force] ▶▶
```

### Parameters

#### -force

(Optional) Specifies that the **clearerrlog** command be processed without confirmation requests. If the **-force** parameter is not supplied, you are prompted to confirm that you want to clear the log.

### Description

This command clears all entries from the error log. The entries are cleared even if there are unfixed errors in the log. It also clears any status events that are in the log.

**Attention:** This command is destructive. Use it only use when you have either rebuilt the clustered system or have fixed a major problem that has caused entries in the error log that you do not want to manually fix.

#### An invocation example

```
clearerrlog -force
```

#### The resulting output

No feedback

---

## dumperrlog

The **dumperrlog** command dumps the contents of the error log to a text file.

### Syntax

```
▶▶ dumperrlog — [-prefix — filename_prefix] ▶▶
```

## Parameters

**-prefix** *filename\_prefix*

(Optional) A file name is created from the prefix and a time stamp, and has the following format:

```
prefix_NNNNNN_YYMMDD_HHMMSS
```

where *NNNNNN* is the node front panel name.

**Note:** If the **-prefix** parameter is not supplied, the dump is directed to a file with a system-defined prefix of **errlog**.

## Description

When run with no parameters, this command dumps the cluster error log to a file using a system-supplied prefix of **errlog**, which includes the node ID and time stamp. When a file name prefix is provided, the same operation is performed but the details are stored in the dumps directory within a file with a name that starts with the specified prefix.

A maximum of ten error-log dump files are kept on the cluster. When the 11th dump is made, the oldest existing dump file is overwritten.

Error log dump files are written to **/dumps/elogs**. The contents of this directory can be viewed using the **!sdumps** command.

Files are not deleted from other nodes until you issue the **cleardumps** command.

### An invocation example

```
dumperrlog -prefix testerrorlog
```

### The resulting output

No feedback

---

## finderr

The **finderr** command analyzes the error log for the highest severity unfixed error.

## Syntax

```
►► finderr ◀◀
```

## Description

The command scans the error log for any unfixed errors. Given a priority ordering within the code, the highest priority unfixed error is returned to standard output.

You can use this command to determine the order in which to fix the logged errors.

### An invocation example

```
finderr
```

### The resulting output

```
Highest priority unfixed error code is [1010]
```

---

## lserrlogbyfcconsistgrp (Deprecated)

The `lserrlogbyfcconsistgrp` command has been deprecated. Use the `lseventlog` command instead.

---

## lserrlogbyfcmap (Deprecated)

The `lserrlogbyfcmap` command has been deprecated. Use the `lseventlog` command instead.

---

## lserrlogbyhost (Deprecated)

The `lserrlogbyhost` command has been deprecated. Use the `lseventlog` command instead.

---

## lserrlogbyiogrp (Deprecated)

The `lserrlogbyiogrp` command has been deprecated. Use the `lseventlog` command instead.

---

## lserrlogbymdisk (Deprecated)

The `lserrlogbymdisk` command has been deprecated. Use the `lseventlog` command instead.

---

## lserrlogbymdiskgrp (Deprecated)

The `lserrlogbymdiskgrp` command has been deprecated. Use the `lseventlog` command instead.

---

## lserrlogbynode (Deprecated)

The `lserrlogbynode` command has been deprecated. Use the `lseventlog` command instead.

---

## lserrlogbyrcconsistgrp (Deprecated)

The `lserrlogbyrcconsistgrp` command has been deprecated. Use the `lseventlog` command instead.

---

## lserrlogbyrcrelationship (Deprecated)

The `lserrlogbyrcrelationship` command has been deprecated. Use the `lseventlog` command instead.

---

## lserrlogbyvdisk (Deprecated)

The `lserrlogbyvdisk` command has been deprecated. Use the `lseventlog` command instead.

---

## lserrlogdumps (Deprecated)

**Attention:** The `svcinfo lserrlogdumps` command is deprecated. Use the `svcinfo lsdumps` command to display a list of files in a particular dumps directory.

---

## lseventlog

Use the `lseventlog` command to display a concise view of the system event log, or a detailed view of one entry from the log.

### Syntax

```
▶▶ lseventlog [-alert yes|no] [-message yes|no] [-monitoring yes|no]
```

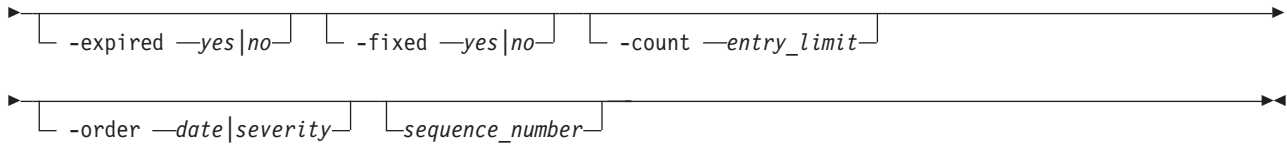

## Parameters

### -alert

Includes events with *alert* status.

### -message

Includes events with *message* status.

### -monitoring

Includes events with *monitoring* status.

### -expired

Includes events with *expired* status.

### -fixed

Includes fixed events.

### -count

Indicates the maximum number of events to display.

### -order *date|severity*

Indicates what order the events should be in. Ordering by *date* displays the oldest events first.

Ordering by *severity* displays the events with the highest severity first. If multiple events have the same severity, then they are ordered by date, with the oldest event being displayed first.

The following list shows the order of severity, starting with the most severe:

1. Unfixed alerts (sorted by error code; the lowest error code has the highest severity)
2. Unfixed messages
3. Monitoring events (sorted by error code; the lowest error code has the highest severity)
4. Expired events
5. Fixed alerts and messages

### *sequence\_number*

Indicates if the command should display a full view of the event.

## Description

This command displays a concise view of the system event log, or a detailed view of one entry from the log. You can sort the events and entries by severity or age.

Table 21 provides the attribute values that can be displayed as output view data.

Table 21. *lseventlog* output

| Attribute                    | Description                                                      | Value             |
|------------------------------|------------------------------------------------------------------|-------------------|
| <i>sequence_number</i>       | Sequence number of the event.                                    | Numeric 0-8000000 |
| <i>first_timestamp</i>       | When the event was added to the log.                             | YYMMDDHHMMSS      |
| <i>first_timestamp_epoch</i> | When the event was added to the log (in seconds) since the epoch | Numeric 32-bit    |
| <i>last_timestamp</i>        | When the event was most recently updated.                        | YYMMDDHHMMSS      |

Table 21. Iseventlog output (continued)

| Attribute            | Description                                                            | Value                                                                                                                                                                                                                                                                                                                                                                                                                                                                                                                                                                                                                                                                                                                                                                                              |
|----------------------|------------------------------------------------------------------------|----------------------------------------------------------------------------------------------------------------------------------------------------------------------------------------------------------------------------------------------------------------------------------------------------------------------------------------------------------------------------------------------------------------------------------------------------------------------------------------------------------------------------------------------------------------------------------------------------------------------------------------------------------------------------------------------------------------------------------------------------------------------------------------------------|
| last_timestamp_epoch | When the event was most recently updated (in seconds) since the epoch. | Numeric 32-bit                                                                                                                                                                                                                                                                                                                                                                                                                                                                                                                                                                                                                                                                                                                                                                                     |
| object_type          | The type of the object the event is logged against.                    | <ul style="list-style-type: none"> <li>• mdisk</li> <li>• mdiskgrp</li> <li>• vdisk (or vdisk copy)</li> <li>• node</li> <li>• host</li> <li>• io_grp (<i>iogroup</i> in <b>dumperrlog</b>)</li> <li>• fc_consist_grp (<i>fcgrp</i> in <b>dumperrlog</b>)</li> <li>• rc_consist_grp (<i>rcgrp</i> in <b>dumperrlog</b>)</li> <li>• fc_map (<i>fcmap</i> in <b>dumperrlog</b>; <i>flash</i> in <b>caterrlog</b>)</li> <li>• rc_relationship (<i>rcmap</i> in <b>dumperrlog</b>; <i>remote</i> in <b>caterrlog</b>)</li> <li>• cluster</li> <li>• controller (<i>device</i> in <b>caterrlog</b> and <b>dumperrlog</b>)</li> <li>• quorum</li> <li>• migrate</li> <li>• email_server (<i>email server</i> in <b>caterrlog</b> and <b>dumperrlog</b>)</li> <li>• enclosure</li> <li>• drive</li> </ul> |
| object_id            | The ID of the object the event is logged against.                      | Numeric 64-bit. Displayed in decimal for all object types except clusters. Clusters are in hexadecimal. Blank for events with object_type <i>cluster</i> .                                                                                                                                                                                                                                                                                                                                                                                                                                                                                                                                                                                                                                         |
| object_name          | The name of the object the event is logged against.                    | Object name format; blank if the object was deleted or does not have a name.                                                                                                                                                                                                                                                                                                                                                                                                                                                                                                                                                                                                                                                                                                                       |
| copy_id              | The VDisk copy ID the event is logged against.                         | 0-1; blank if not a vdiskcopy event.                                                                                                                                                                                                                                                                                                                                                                                                                                                                                                                                                                                                                                                                                                                                                               |
| reporting_node_id    | The ID of the node that reported the event.                            | Numeric 64-bit; blank if the event was reported by the cluster.                                                                                                                                                                                                                                                                                                                                                                                                                                                                                                                                                                                                                                                                                                                                    |
| reporting_node_name  | The name of the node that reported the event.                          | Object name format; blank if the node was deleted or if the event was reported by the cluster.                                                                                                                                                                                                                                                                                                                                                                                                                                                                                                                                                                                                                                                                                                     |
| root_sequence_number | Sequence number of the root, causal event.                             | Numeric, 1-8000000; blank if there is no root.                                                                                                                                                                                                                                                                                                                                                                                                                                                                                                                                                                                                                                                                                                                                                     |
| event_count          | The number of reported events that have been combined into this event. | Numeric 32-bit.                                                                                                                                                                                                                                                                                                                                                                                                                                                                                                                                                                                                                                                                                                                                                                                    |
| status               | The event category.                                                    | <ul style="list-style-type: none"> <li>• alert</li> <li>• message</li> <li>• monitoring</li> <li>• expired</li> </ul>                                                                                                                                                                                                                                                                                                                                                                                                                                                                                                                                                                                                                                                                              |

Table 21. lseventlog output (continued)

| Attribute         | Description                                                                                                                                                                           | Value                                                                                                                     |
|-------------------|---------------------------------------------------------------------------------------------------------------------------------------------------------------------------------------|---------------------------------------------------------------------------------------------------------------------------|
| fixed             | Indicates whether the event was marked fixed (for an alert) or read (for a message).                                                                                                  | <ul style="list-style-type: none"> <li>• yes</li> <li>• no (for events that cannot be fixed, or are not fixed)</li> </ul> |
| auto_fixed        | Indicates whether event was marked fixed by the code.                                                                                                                                 | <ul style="list-style-type: none"> <li>• yes</li> <li>• no (for events that cannot be fixed, or are not fixed)</li> </ul> |
| notification_type | The type of event notification.                                                                                                                                                       | <ul style="list-style-type: none"> <li>• error</li> <li>• warning</li> <li>• informational</li> <li>• none</li> </ul>     |
| event_id          | The event ID.                                                                                                                                                                         | 6-digit numeric                                                                                                           |
| event_id_text     | The description associated with the event ID.                                                                                                                                         | Text, max 200 bytes. Appears in the CLI requested language.                                                               |
| error_code        | The error code associated with this event.                                                                                                                                            | 4-digit numeric; blank if there is no error code.                                                                         |
| error_code_text   | The description associated with the error code.                                                                                                                                       | Text (maximum of 200 bytes); blank if there is no error code. Appears in CLI requested language.                          |
| description       | The description associated with the event. If the event has an error code, this value is the same as the error_code_text field; otherwise, it is the same as the event_id_text field. | Text (maximum of 200 bytes).                                                                                              |
| sense1            | Sixteen bytes of hex-encoded sense data. The least significant byte is on the left.                                                                                                   | Sixteen two-character hex numbers separated by spaces.                                                                    |
| sense2            |                                                                                                                                                                                       |                                                                                                                           |
| sense3            |                                                                                                                                                                                       |                                                                                                                           |
| sense4            |                                                                                                                                                                                       |                                                                                                                           |
| sense5            |                                                                                                                                                                                       |                                                                                                                           |
| sense6            |                                                                                                                                                                                       |                                                                                                                           |
| sense7            |                                                                                                                                                                                       |                                                                                                                           |
| sense8            |                                                                                                                                                                                       |                                                                                                                           |

### An invocation example

This example shows events in January 2010:

```
lseventlog -filtervalue last_timestamp>=100101000000:last_timestamp<100201000000
```

This example shows all unfixed 1065 errors, in order of occurrence:

```
lseventlog -filtervalue error_code=1065:fixed=no
```

This example lists the most critical event:

```
lseventlog -order severity -count 1
```

This example shows the concise view:

```
lseventlog
```

```
sequence_number:last_timestamp:object_type:object_id:object_name:copy_id:
status:fixed:event_id:error_code:description
400:100106132413:vdisk:2:my_vdisk:1:alert:no:060001:1865:
Space Efficient Virtual Disk Copy offline due to insufficient space
401:100106140000:cluster::ldcluster-2::message:no:981001:
:Cluster Fabric View updated by fabric discovery
```

This example shows the full view:

```
lseventlog 400
```

```
sequence_number 400
first_timestamp 100106132413
first_timestamp_epoch 1256025652
last_timestamp 100106132413
last_timestamp_epoch 1256025652
object_type vdisk
object_id 2
object_name my_vdisk
copy_id 1
reporting_node_id 2
reporting_node_name node2
root_sequence_number
event_count 1
status alert
fixed no
auto_fixed no
notification_type warning
event_id 060001
event_id_text Space Efficient Virtual Disk Copy offline due to insufficient space
error_code 1865
error_code_text Space Efficient Virtual Disk Copy offline due to insufficient space
sense1 00 00 00 00 00 00 00 00 00 00 00 00 00 01 23 42 AB
sense2 00 00 00 01 20 A3 14 22 01 00 00 00 00 00 02 00
sense3 00 00 00 00 00 00 00 00 00 00 00 00 00 00 00 00
sense4 00 00 00 00 00 00 00 00 00 00 00 00 00 00 00 00
sense5 00 00 00 00 00 00 00 00 00 00 00 00 00 00 00 00
sense6 00 00 00 00 00 00 00 00 00 00 00 00 00 00 00 00
sense7 00 00 00 00 00 00 00 00 00 00 00 00 00 00 00 00
sense8 00 00 00 00 00 00 00 00 00 00 00 00 00 00 00 00
```

---

## lssyslogserver

The `lssyslogserver` command returns a concise list or a detailed view of syslog servers that are configured on the cluster.

### Syntax

```
▶▶ lssyslogserver — [-nohdr] [-delim delimiter] [syslog_server_name] [syslog_server_id] ▶▶
```

### Parameters

#### `-nohdr`

(Optional) By default, headings are displayed for each column of data in a concise style view, and for each item of data in a detailed style view. The `-nohdr` parameter suppresses the display of these headings.

**Note:** If there is no data to be displayed, headings are not displayed.

### **-delim** *delimiter*

(Optional) By default in a concise view, all columns of data are space-separated. The width of each column is set to the maximum possible width of each item of data. In a detailed view, each item of data has its own row, and if the headers are displayed, the data is separated from the header by a space. The **-delim** parameter overrides this behavior. Valid input for the **-delim** parameter is a one-byte character. If you enter `-delim :` on the command line, the colon character (`:`) separates all items of data in a concise view; for example, the spacing of columns does not occur. In a detailed view, the data is separated from its header by the specified delimiter.

### *syslog\_server\_name* | *syslog\_server\_id*

(Optional) Specifies the name or ID of an existing syslog server. When you use this parameter, a detailed view of the specified syslog server is returned. If you do not specify a syslog server name or ID, then a concise view of all syslog servers is displayed.

## Description

Use this command to display a concise list or a detailed view of syslog servers that are configured on the cluster.

### A concise invocation example

```
lssyslogserver -delim :
```

### The concise resulting output

```
id:name:IP_address:facility:error:warning:info
0:syslog0:192.135.60.4:0:on:on:on
1:newserver:192.136.70.7:4:on:off:off
```

### A detailed invocation example

```
lssyslogserver 0
```

### The detailed resulting output

```
id 0
name syslog0
IP_address 192.135.60.4
facility 0
error on
warning on
info on
```

---

## setlocale

The **setlocale** command changes the locale setting for the clustered system (system). It also changes command output to the chosen language.

## Syntax

```
▶▶ setlocale — — -locale — locale_id —————▶▶
```

## Parameters

### **-locale** *locale\_id*

Specifies the locale ID.



## Description

This command changes the language in which error messages are displayed as output from the command-line interface. Subsequently, all error messages from the command-line tools are generated in the chosen language. This command is run when you request a change of language (locale) and is generally run from the web page. Issue the **setlocale** command to change the locale setting for the system; all interface output is changed to the chosen language. For example, to change the language to Japanese, type the following:

```
setlocale -locale 3
```

where **3** is the value for Japanese. The following values are supported:

- **0** US English (default)
- **1** Simplified Chinese
- **2** Traditional Chinese
- **3** Japanese
- **4** French
- **5** German
- **6** Italian
- **7** Spanish

**Note:** This command does not change the front panel display panel settings.

### An invocation example (where 3 is Japanese)

```
setlocale -locale 3
```

### The resulting output

No feedback

---

## svqueryclock

The **svqueryclock** command returns the date, time, and current time-zone of the clustered system (system).

## Syntax

▶▶—svqueryclock—◀◀

## Description

This command returns the date, time and current time-zone of the system.

### An invocation example

```
svqueryclock
```

### The resulting output

```
Mon Nov 25 14:59:28 GMT 2002
```

---

## writesernum

Use the **writesernum** command to write the node serial number into the planar NVRAM.

## Syntax

```
▶▶ writesernum — — -sernum — serial_number — — $\left. \begin{array}{l} \textit{node_id} \\ \textit{node_name} \end{array} \right\}$ —————▶▶
```

## Parameters

**-sernum** *serial\_number*

(Required) Specifies the serial number to write to the nonvolatile memory of the system planar.

*node\_id* | *node\_name*

(Required) Specifies the node where the system planar is located. The serial number is written to this system planar. This name is not the worldwide node name (WWNN).

## Description

This command writes the node serial number into the planar NVRAM and then reboots the system. You can find the serial number at the front of the node without having to remove it from the rack. The seven-digit alphanumeric serial number is located on a label on the front of the node. The serial number on the label might contain a hyphen. Omit this hyphen when typing the serial number with the **writesernum** command.

**Note:** Once you have written the serial number to the planar NVRAM, you can issue the **lsnodevdpd** command to verify that the number is correct. The `system_serial_number` field contains the serial number.

### An invocation example

```
writesernum -sernum 1300027 node1
```

### The resulting output

No feedback

---

## Chapter 10. Controller command

The controller command modifies the name of a storage controller.

---

### chcontroller

The **chcontroller** command modifies the attributes of a controller.

#### Syntax

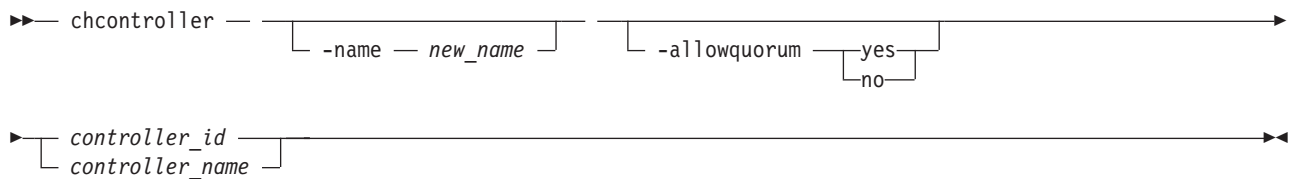

#### Parameters

**-name** *new\_name*

(Optional) Specifies the new name to be assigned to the controller.

**-allowquorum** **yes** | **no**

(Optional) Specifies that the controller is allowed or is not allowed to support quorum disks. A value of **yes** enables a suitable controller to support quorum disks. A value of **no** disables a controller from supporting quorum disks, provided that the specified controller is not currently hosting a quorum disk.

*controller\_id* | *controller\_name*

(Required) Specifies the controller to modify; use either the controller name or the controller ID.

#### Description

This command changes the name of the controller that is specified by the *controller\_id* | *controller\_name* variable to the value that you specify with the **-name** parameter.

If any controller that is associated with an MDisk shows the **allow\_quorum** attribute set to **no** with the **lscontroller** command, the set quorum action fails for that MDisk. Before using the **chcontroller** command to set the **-allowquorum** parameter to **yes** on any disk controller, check the following website to see whether the controller supports quorum.

Support for SAN Volume Controller (2145) website at [www.ibm.com/storage/support/2145](http://www.ibm.com/storage/support/2145)

You can add a new disk controller system to your SAN at any time. Follow the switch zoning guidelines in the section about switch zoning. Also, ensure that the controller is set up correctly for use with the clustered system (system).

To add a new disk controller system to a running configuration, ensure that the system has detected the new storage MDisks by issuing the **detectmdisk** command. The controller has automatically been assigned a default name. If you are unsure of which controller is presenting the MDisks, issue the **lscontroller** command to list the controllers. The new controller is listed with the highest numbered default name. Record the controller name and follow the instructions in the section about determining a disk controller system name.

Give this controller a descriptive name by issuing the following command:

```
chcontroller -name newname oldname
```

List the unmanaged MDisks by issuing the following command:

```
lsmdisk -filtervalue mode=unmanaged:controller_name=newname
```

These MDisks correspond to the RAID arrays or partitions that you have created. Record the field controller LUN number. The field controller LUN number corresponds with the LUN number that you assigned to each of the arrays or partitions.

Create a new managed disk group and add only the RAID arrays that belong to the new controller to this storage pool. Avoid mixing RAID types; for each set of RAID array types (for example, RAID-5 or RAID-1), create a new storage pool. Assign this storage pool an appropriate name; if your controller is called FAST650-abc and the storage pool contains RAID-5 arrays, assign the MDisk a name similar to **F600-abc-R5**. Issue the following command:

```
mkmdiskgrp -ext 16 -name mdisk_grp_name
-mdisk colon-separated list of RAID-x mdisks returned
```

**Note:** This creates a new storage pool with an extent size of 16 MB.

#### **An invocation example**

```
chcontroller -name newtwo 2
```

#### **The resulting output**

No feedback

---

## Chapter 11. Drive commands

Drive commands capture information that can assist you with managing drives.

---

### applydrivesoftware

Use the **applydrivesoftware** command to upgrade drives.

#### Syntax

```
▶▶ applydrivesoftware -- -file name -- -type firmware -drive drive_id -- --
▶ -force
```

#### Parameters

##### -file

Specifies the firmware upgrade file that exists in the `/home/admin/upgrade/` directory.

##### -type

Specifies the type of download.

##### -drive

Specifies a drive ID to apply software to, from the package provided.

##### -force

(Optional) This disables redundancy checking. In the unlikely event that a software installation causes the drive to fail, disabling redundancy checking might cause loss of data, or loss of access to data.

**Note:** This option is not recommended for redundant RAID configurations.

#### Description

This command upgrades drives. After you install a firmware package and run a single CLI, the system applies updates to the drive that has an update in that package. The system should stop if any problems occur.

#### An invocation example

```
applydrivesoftware -file
drivemicrocodepackagev1 -type fpga -drive 4
```

---

### chdrive

Use the **chdrive** command to change the drive properties.

#### Syntax

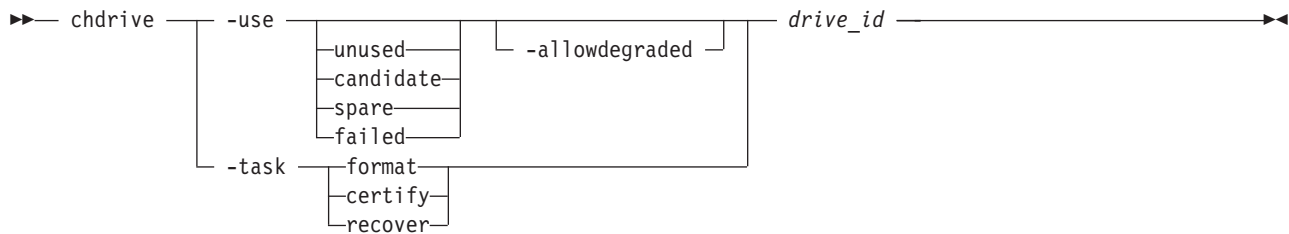

## Parameters

### -use

Describes the role of the drive:

- unused: the drive is not in use and will not be used as a spare
- candidate: the drive is available for use in an array
- spare: the drive can be used as a hot spare if required
- failed: the drive has failed.

**Note:** To create member drives, add the drives to arrays using the **charray** command.

### -allowdegraded

(Optional) Permits permission for a change of drive to continue, even if a hotspare is not available.

### -task

Causes the drive to perform a task:

- format: a drive is formatted for use in an array; only permitted when drive is a candidate or has failed validation
- certify: the disk is analyzed to verify the integrity of the data it contains; permitted for any drive that is a candidate, spare, or member
- recover: recover an offline SSD drive without losing data; permitted when the drive is offline because a build is required, or when the drive has failed validation

**Note:** You can track the drive progress using the **lsdriveprogress** command.

*drive\_id*

The identity of the drive.

## Description

Use this command to change the drive properties.

```
chdrive -use spare 1
```

---

## lsdrive

Use the **lsdrive** command to display configuration information and drive VPD.

## Syntax



## Parameters

*drive\_id*

The identity of the drive.

## Description

Use this command to display configuration information and drive VPD.

**Note:** Filtering should be permitted on all concise fields.

Table 22 describes possible outputs.

Table 22. *Isdrive* output

| Attribute             | Value                                                                                                                                                                                                                                                                                                                                                                                                                                                         |
|-----------------------|---------------------------------------------------------------------------------------------------------------------------------------------------------------------------------------------------------------------------------------------------------------------------------------------------------------------------------------------------------------------------------------------------------------------------------------------------------------|
| id                    | The ID of the drive.                                                                                                                                                                                                                                                                                                                                                                                                                                          |
| status                | The summary status of the drive.                                                                                                                                                                                                                                                                                                                                                                                                                              |
| error_sequence_number | The error sequence number describing the cause of the drive status: <ul style="list-style-type: none"><li>• online: blank</li><li>• degraded: populated if associated with an error</li><li>• offline: must be populated</li></ul> <b>Note:</b> Error sequence numbers indicate an entry in the event log. This includes entries that are both errors, and informational messages (for example, the drive is formatting).                                     |
| use                   | The current role of the drive: <ul style="list-style-type: none"><li>• unused: the drive which is not configured to be used by anything</li><li>• candidate: the drive is available to be configured</li><li>• spare: the drive is configured as a spare, to be used if the arrays fail members</li><li>• member: the drive is configured as a member of an array</li><li>• failed: the drive has been rejected, and is no longer available for use</li></ul> |
| UID                   | The unique ID reported by the drive.                                                                                                                                                                                                                                                                                                                                                                                                                          |
| tech_type             | The drive technology used.                                                                                                                                                                                                                                                                                                                                                                                                                                    |
| capacity              | The capacity of disk, excluding quorum area.                                                                                                                                                                                                                                                                                                                                                                                                                  |
| block_size            | The block size of the disk.                                                                                                                                                                                                                                                                                                                                                                                                                                   |
| vendor_id             | The manufacturer of the drive.                                                                                                                                                                                                                                                                                                                                                                                                                                |
| product_id            | The product ID of the drive.                                                                                                                                                                                                                                                                                                                                                                                                                                  |
| FRU_part_number       | The FRU part number of the drive.                                                                                                                                                                                                                                                                                                                                                                                                                             |
| FRU_identity          | The 11S number combining manufacturing part number and serial number.                                                                                                                                                                                                                                                                                                                                                                                         |
| RPM                   | The specified RPM of the disk.                                                                                                                                                                                                                                                                                                                                                                                                                                |
| firmware_level        | Firmware level of the disk; blank if unknown.                                                                                                                                                                                                                                                                                                                                                                                                                 |
| FPGA_level            | The FPGA level, if applicable. Blank if not applicable or unknown.                                                                                                                                                                                                                                                                                                                                                                                            |
| mdisk_id              | The ID of the array MDisk that the drive is a member of.                                                                                                                                                                                                                                                                                                                                                                                                      |
| mdisk_name            | The name of the MDisk that the drive is a member of.                                                                                                                                                                                                                                                                                                                                                                                                          |
| member_id             | The ID of the MDisk array member.                                                                                                                                                                                                                                                                                                                                                                                                                             |
| enclosure_id          | <ul style="list-style-type: none"><li>• If the drive is contained in an enclosure (not a node) and the slot position is known, this is the ID of the enclosure in which the drive is located.</li><li>• If the drive is contained in a node (not an enclosure), this is blank.</li><li>• If the enclosure ID has not been determined yet, this is blank.</li></ul>                                                                                            |
| slot_id               | The slot_id of the drive in the enclosure or node. It can be referred to as the drive bay or location. This can be blank.                                                                                                                                                                                                                                                                                                                                     |
| node_name             | For a drive contained within a node, the node name where the drive is located. For a drive contained within an enclosure, blank.                                                                                                                                                                                                                                                                                                                              |

Table 22. *lsdrive* output (continued)

| Attribute     | Value                                                                                                                          |
|---------------|--------------------------------------------------------------------------------------------------------------------------------|
| node_id       | For a drive contained within a node, the node ID where the drive is located. For a drive contained within an enclosure, blank. |
| quorum_id     | The ID of quorum disk; blank if not quorum disk.                                                                               |
| port_1_status | The connectivity status of the target for MDisk enumeration, with states.                                                      |
| port_2_status |                                                                                                                                |

**Concise invocation example:**

```
lsdrive -delim :
```

**The resulting output:**

```
id:status:error_sequence_number:use:tech_type:capacity:mdisk_id:mdisk_name:member_id:enclosure_id:slot_id
0:online::member:sas_ssd:20GB:0:mdisk0:0:1:2
1:offline:345:member:sas_ssd:20GB:0:mdisk0:0:1:3
2:online::member:sas_ssd:20GB:0:mdisk0:0:1:4
```

**A detailed invocation example:**

```
lsdrive 0
```

**The resulting output:**

```
id:0
status:online
error_sequence_number:
use:member
UID:20000004cf4cd2c0
tech_type:ssd
capacity:20GB
block_size:512
vendor_id:IBM
product_id:I8MR1337 W00Y4Y1
FRU_part_number:AAAAAAA
FRU_identity:11S1817115Y41337171001
RPM:15000
firmware_level:3.02
FPGA_level:1.99
mdisk_id:0
mdisk_name:mdisk0
member_id:0
enclosure_id:1
slot:2
node_id:
node_name:
quorum_id:
port_1_status:online
port_2_status:online
```

---

## lsdrivelba

Use the **lsdrivelba** command to map array MDisk logical block address (LBA) to a set of drives.

### Syntax

```
➤ — lsdrivelba — -mdisklba — lba — -mdisk — mdisk_id — | mdisk_name ————— ➤
```



## Parameters

### **-mdisk**

The ID of the MDisk.

### **-mdisklba**

The logical block address (LBA) on the MDisk. The LBA must be specified in hex, with a 0x prefix.

## Description

This command maps the array MDisk logical block address (LBA) to a set of drives.

Table 23 describes possible outputs.

Table 23. *lsdrive lba* output

| Attribute   | Value                                                                                                                                                                                                                                                            |
|-------------|------------------------------------------------------------------------------------------------------------------------------------------------------------------------------------------------------------------------------------------------------------------|
| drive_id    | The ID of drive; blank if no configured array member exists (for example, in a degraded array).                                                                                                                                                                  |
| type        | The type of information on the disk: <ul style="list-style-type: none"><li>• parity - LBA range contains parity (RAID levels 5 and 6 only)</li><li>• qparity - LBA range contains qparity (RAID level 6 only)</li><li>• data - LBA range contains data</li></ul> |
| drive_lba   | The LBA on the drive.                                                                                                                                                                                                                                            |
| drive_start | The start of range of LBAs (strip) on the drive.                                                                                                                                                                                                                 |
| drive_end   | The end of range of LBAs (strip) on the drive.                                                                                                                                                                                                                   |
| mdisk_start | The start of range of LBAs (strip) on the array MDisk.                                                                                                                                                                                                           |
| mdisk_end   | The end of range of LBAs (strip) on the array MDisk.                                                                                                                                                                                                             |

This is an example of a five-member RAID-5 array with strip size of 256 KB:

### An invocation example

```
lsdrive lba -mdisklba 0x000 -mdisk 2 -delim :
```

### The resulting output

```
drive_id:type:drive_lba:drive_start:drive_end:mdisk_start:mdisk_end
0:data:0x0000000000000000:0x0000000000000000:0x0000000000000200:0x0000000000000000:0x0000000000000200
4:parity:0x0000000000000000:0x0000000000000000:0x0000000000000200:0x0000000000000000:0x0000000000000200
```

---

## lsdriveprogress

Use the **lsdriveprogress** command to view the progress of various drive tasks.

## Syntax

```
▶▶—lsdriveprogress—┐
└drive_id┘◀◀
```

## Parameters

### **drive\_id**

(Optional) The drive for which you want to view progress.

## Description

The following outputs are possible:

### **drive\_id**

The ID for the drive with the active task.

**task** The type of task:

- format
- certify
- recover

### **progress**

The percentage complete of the job.

### **estimated\_completion\_time**

The estimated completion time (YYMMDDHHMMSS).

### **An invocation example**

```
lsdriveprogress -delim :
```

### **The resulting output**

```
drive_id:task:progress:estimated_completion_time
0:format:10:091118131056
9:certify:25:991231235959
```

### **An invocation example**

```
lsdriveprogress 9 -delim :
```

### **The resulting output**

```
9:certify:25:991231235959
```

---

## triggerdrivedump

Use the **triggerdrivedump** command to collect support data from a disk drive. This data can help to understand problems with the drive, and does not contain any data that applications may have written to the drive.

## Syntax

▶▶— **triggerdrivedump** —*drive\_id*—▶▶

## Parameters

### **drive\_id**

The ID of the drive to dump.

### **An invocation example**

```
triggerdrivedump 1
```

### **The resulting output**

```
Dump file created on node id [2]
```

---

## Chapter 12. Email and event notification commands

You can use the command-line interface (CLI) to enable your system to send notifications.

The following email and event notification commands are available:

### **chcluster**

Enables the inventory notification function by specifying how often notifications are sent to recipients. See the “chcluster” on page 105 command in the Chapter 8, “Clustered system commands,” on page 101 section.

### **chemail**

Sets or modifies contact information for email event notifications.

### **chemailserver**

Modifies the parameters of an existing email server object.

### **chemailuser**

Allows you to modify the email recipient's information.

### **chsnmpserver**

Modifies the parameters of an existing SNMP server.

### **chsyslogserver**

Modifies the parameters of an existing syslog server.

### **lscluster**

Provides information about the addition of email notification recipients to the cluster. See the “lscluster” on page 206 command in the Chapter 17, “Information commands,” on page 205 section.

### **lsemailserver**

Returns a concise list or a detailed view of email servers that are configured on the cluster. See the “lsemailserver” on page 219 command in the Chapter 17, “Information commands,” on page 205 section.

### **lsemailuser**

Generates a report that lists the users (by user ID or type of user [local or support]) who are receiving email event and inventory notifications. See the “lsemailuser” on page 220 command in the Chapter 17, “Information commands,” on page 205 section.

### **lssnmpserver**

Returns a concise list or a detailed view of SNMP servers that are configured on the cluster. See the “lssnmpserver” on page 285 command in the Chapter 17, “Information commands,” on page 205 section.

### **lssyslogserver**

Returns a concise list or a detailed view of syslog servers that are configured on the cluster. See the “lssyslogserver” on page 135 command in the Chapter 17, “Information commands,” on page 205 section.

### **mkemailserver**

Creates an email server object that describes a remote Simple Mail Transfer Protocol (SMTP) email server.

### **mkemailuser**

Allows you to specify the user, the receiving server address, the type of email event notification, and to enable inventory notification in the email event notification facility.

- mksnmpserver**  
Creates an SNMP server to receive notifications.
- mksyslogserver**  
Creates a syslog server to receive notifications.
- rmailserver**  
Deletes the specified email server object.
- rmailuser**  
Removes an existing email recipient from the email event notification function.
- rmsnmpserver**  
Deletes the specified SNMP server.
- rmsyslogserver**  
Deletes the specified syslog server.
- sendinventoryemail**  
Sends an inventory email notification to all inventory email recipients.
- startemail**  
Starts the email notification function.
- stopemail**  
Disables the email notification function.
- testemail**  
Sends a test email to a specified user or to all users using the email notification function.

## chemail

The **chemail** command can be used to set or modify contact information for email event notifications. To modify settings, at least one of the parameters must be specified.

### Syntax

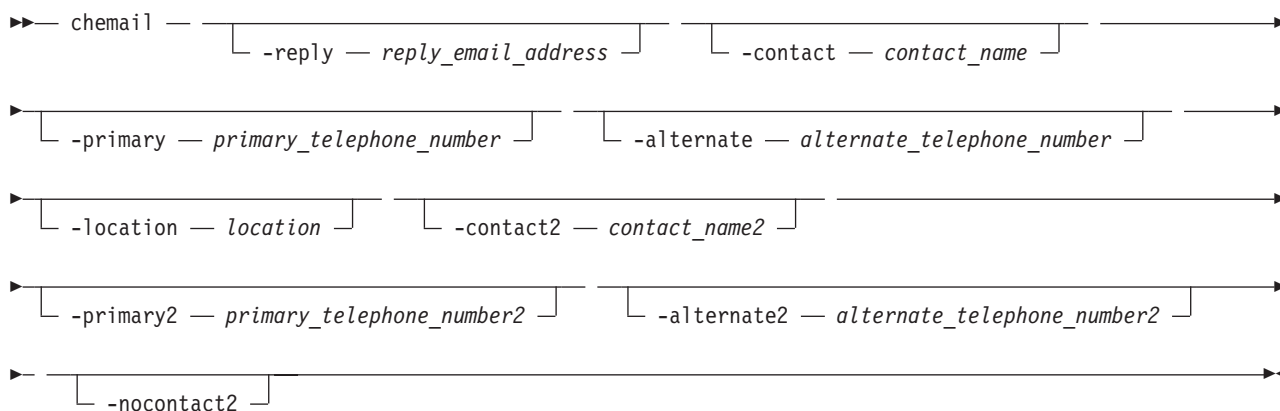

### Parameters

- reply** *reply\_email\_address*  
(Optional) Specifies the email address to which a reply is sent.
- contact** *contact\_name*  
(Optional) Specifies the name of the person to receive the email.
- primary** *primary\_telephone\_number*  
(Optional) Specifies the primary contact telephone number.

- alternate** *alternate\_telephone\_number*  
(Optional) Specifies the alternate contact telephone number that is used when you cannot reach the primary contact on the primary phone.
- location** *location*  
(Optional) Specifies the physical location of the system that is reporting the error. The *location* value must not contain punctuation or any other characters that are not alphanumeric or spaces.
- contact2** *contact\_name2*  
(Optional) Specifies the name of the second contact person to receive the email.
- primary2** *primary\_telephone\_number2*  
(Optional) Specifies the primary contact telephone number for the second contact person.
- alternate2** *alternate\_telephone\_number2*  
(Optional) Specifies the alternate contact telephone number for the second contact person.
- nocontact2**  
(Optional) Removes all the contact details for the second contact person.

## Description

This command sets or modifies contact information that is used by the email event notification facility.

**Note:** If you are starting the email event notification facility, the **reply**, **contact**, **primary**, and **location** parameters are required. If you are modifying contact information used by the email event notification facility, at least one of the parameters must be specified.

### An invocation example

```
chemail -primary 0441234567 -location 'room 256 floor 1 IBM'
```

### The resulting output

[No feedback]

---

## chemailserver

The **chemailserver** command modifies the parameters of an existing email server object.

### Syntax

```

▶▶ chemailserver — [-name — server_name] [-ip — ip_address]
▶ [-port — port] [email_server_name] [email_server_id]

```

### Parameters

- name** *server\_name*  
(Optional) Specifies a unique name to assign to the email server object. The name must be a 1-through 63-character string, and cannot start with a hyphen or number. When specifying a server name, *emailserver* is a reserved word.
- ip** *ip\_address*  
(Optional) Specifies the IP address of the email server object. This must be a valid IPv4 or IPv6 address. IPv6 addresses can be zero compressed.

**-port** *port*

(Optional) Specifies the port number for the email server. This must be a value of 0 - 65535. The default value is 25.

*email\_server\_name* | *email\_server\_id*

(Required) Specifies the name or ID of the server object to be modified.

## Description

Use this command to change the settings of an existing email server object. The email server object describes a remote Simple Mail Transfer Protocol (SMTP) email server.

You must specify either the current name or the ID of the object returned at creation time. Use the **lserver** command to obtain this ID.

### An invocation example

```
chemailserver -name newserver 0
```

### The resulting output

```
none
```

---

## chemailuser

The **chemailuser** command modifies the settings that are defined for an email recipient.

### Syntax

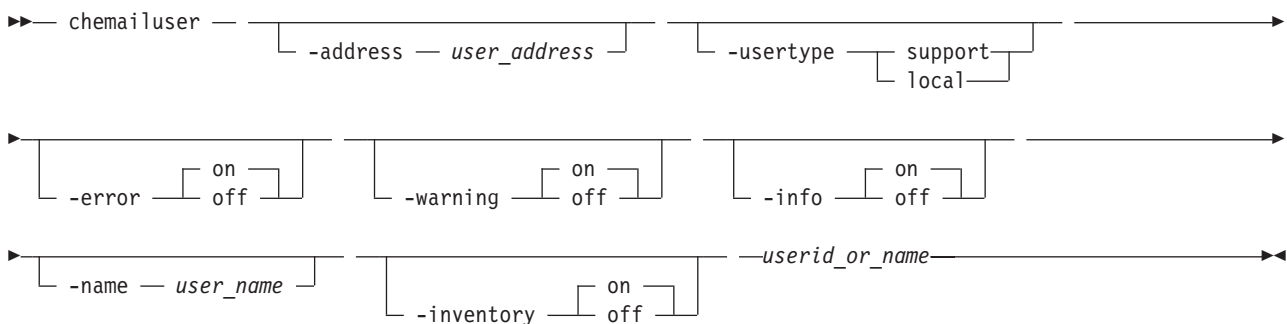

### Parameters

**-address** *user\_address*

(Optional) Specifies the email address of the person receiving the email or inventory notifications, or both. The *user\_address* value must be unique.

**-usertype** **support** | **local**

(Optional) Specifies the type of user, either local or support, based on the following definitions:

**support**

Address of the support organization that provides vendor support.

**local** All other addresses.

**-error** **on** | **off**

(Optional) Specifies whether the recipient receives error-type event notifications. Set to **on**, error-type event notifications are sent to the email recipient. Set to **off**, error-type event notifications are not sent to the recipient.

**-warning on | off**

(Optional) Specifies whether the recipient receives warning-type event notifications. Set to on, warning-type event notifications are sent to the email recipient. Set to off, warning-type event notifications are not sent to the recipient.

**-info on | off**

(Optional) Specifies whether the recipient receives informational event notifications. Set to on, informational event notifications are sent to the email recipient. Set to off, informational event notifications are not sent to the recipient.

**-name *user\_name***

(Optional) Specifies the user name of the new email event notification recipient. The *user\_name* value must be unique, must not contain spaces, and must not contain all numbers. The name **emailuser*n***, where *n* is a number, is reserved and cannot be specified as one of your user names.

**-inventory on | off**

(Optional) Specifies whether this recipient receives inventory email notifications.

***userid\_or\_name***

(Required) Specifies the email recipient for whom you are modifying settings.

## Description

This command modifies the settings that are established for an email recipient. Standard rules regarding names apply; therefore, it is not possible to change a name to **emailuser*n***, where *n* is a number.

**Note:** Before the **usertype** parameter can be set to support, the **-warning** and **-info** flags must be set to off.

### An invocation example

The following example modifies email settings for email recipient **manager2008**:

```
chemailuser -usertype local manager2008
```

### The resulting output

[no feedback]

---

## chsnmpserver

The **chsnmpserver** command modifies the parameters of an existing SNMP server.

### Syntax

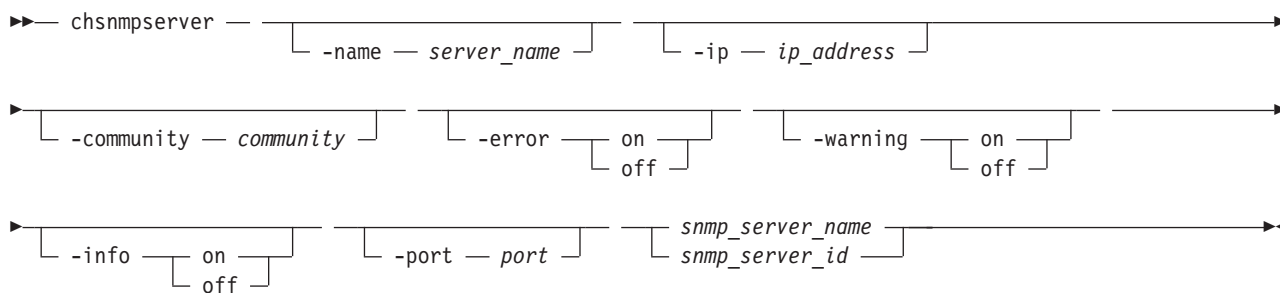

## Parameters

**-name** *server\_name*

(Optional) Specifies a name to assign to the SNMP server. The name must be unique. When specifying a server name, *snmp* is a reserved word.

**-ip** *ip\_address*

(Optional) Specifies an IP address to assign to the SNMP server. This must be a valid IPv4 or IPv6 address.

**-community** *community*

(Optional) Specifies the community name for the SNMP server.

**-error on | off**

(Optional) Specifies whether the server receives error notifications. Set to *on*, error notifications are sent to the SNMP server. Set to *off*, error notifications are not sent to the SNMP server.

**-warning on | off**

(Optional) Specifies whether the server receives warning notifications. Set to *on*, warning notifications are sent to the SNMP server. Set to *off*, warning notifications are not sent to the SNMP server.

**-info on | off**

(Optional) Specifies whether the server receives information notifications. Set to *on*, information notifications are sent to the SNMP server. Set to *off*, information notifications are not sent to the SNMP server.

**-port** *port*

(Optional) Specifies the remote port number for the SNMP server. This must be a value of 1 - 65535.

*snmp\_server\_name | snmp\_server\_id*

(Required) Specifies the name or ID of the server to be modified.

## Description

Use this command to change the settings of an existing SNMP server. You must specify either the current name of the server or the ID returned at creation time. Use the **lssnmpserver** command to obtain this ID.

### An invocation example

```
chsnmpserver -name newserver 0
```

### The resulting output

No feedback

---

## chsyslogserver

The **chsyslogserver** command modifies the parameters of an existing syslog server.

### Syntax

```
▶▶ chsyslogserver — [-name — server_name] [-ip — ip_address]
▶ [-facility — facility] [-error [on | off]] [-warning [on | off]]
```



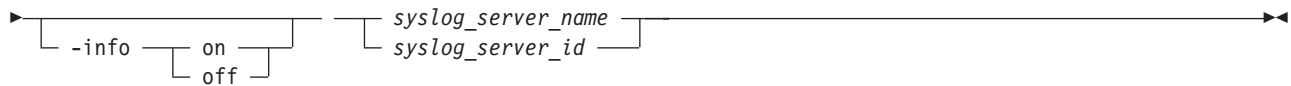

## Parameters

### **-name** *server\_name*

(Optional) Specifies a name to assign to the syslog server. The name must be unique. When specifying a server name, `syslog` is a reserved word.

### **-ip** *ip\_address*

(Optional) Specifies an IP address to assign to the syslog server. This must be a valid IPv4 or IPv6 address.

### **-facility** *facility*

(Optional) Specifies a facility number to identify the origin of the message to the receiving server. Servers configured with facility values of 0 - 3 receive syslog messages in concise format. Servers configured with facility values of 4 - 7 receive syslog messages in fully-expanded format.

### **-error on | off**

(Optional) Specifies whether the server receives error notifications. Set to `on`, error notifications are sent to the syslog server. Set to `off`, error notifications are not sent to the syslog server.

### **-warning on | off**

(Optional) Specifies whether the server receives warning notifications. Set to `on`, warning notifications are sent to the syslog server. Set to `off`, warning notifications are not sent to the syslog server.

### **-info on | off**

(Optional) Specifies whether the server receives information notifications. Set to `on`, information notifications are sent to the syslog server. Set to `off`, information notifications are not sent to the syslog server.

### *syslog\_server\_name* | *syslog\_server\_id*

(Required) Specifies the name or ID of the server to be modified.

## Description

Use this command to change the settings of an existing syslog server. You must specify either the current name of the server or the ID returned at creation time. Use the **lssyslogserver** command to obtain this ID.

### An invocation example

```
chsyslogserver -facility 5 2
```

### The resulting output

```
none
```

## mkemailserver

The **mkemailserver** command creates an email server object that describes a remote Simple Mail Transfer Protocol (SMTP) email server.

## Syntax

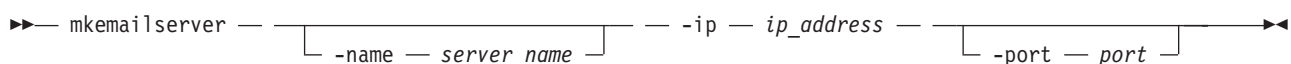

## Parameters

### **-name** *server\_name*

(Optional) Specifies a unique name to assign to the email server object. The name must be a 1-through 63-character string, and cannot start with a hyphen or number. If a name is not specified, then a system default of `emailservern` is applied, where *n* is the object ID. When specifying a server name, `emailserver` is a reserved word.

### **-ip** *ip\_address*

(Required) Specifies the IP address of a remote email server. This must be a valid IPv4 or IPv6 address. IPv6 addresses can be zero compressed.

### **-port** *port*

(Optional) Specifies the port number for the email server. This must be a value of 1 - 65535. The default value is 25.

## Description

This command creates an email server object that represents the SMTP server. The SAN Volume Controller uses the email server to send event notification and inventory emails to email users. It can transmit any combination of error, warning, and informational notification types.

The SAN Volume Controller supports up to six email servers to provide redundant access to the external email network. The email servers are used in turn until the email is successfully sent from the SAN Volume Controller. The attempt is successful when the SAN Volume Controller gets a positive acknowledgement from an email server that the email has been received by the server.

### An invocation example

```
mkemailserver -ip 2.2.2.2 -port 78
```

### The resulting output

```
Emailserver id [2] successfully created
```

---

## mkemailuser

The **mkemailuser** command adds a recipient of email event and inventory notifications to the email event notification facility. You can add up to twelve recipients, one recipient at a time.

## Syntax

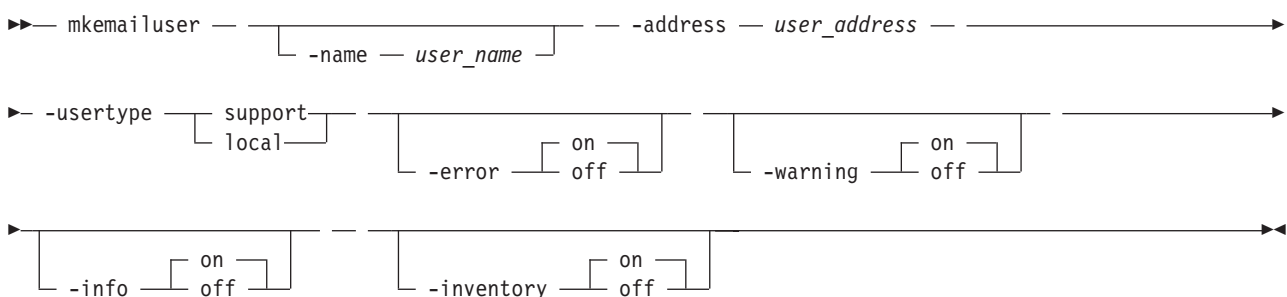

## Parameters

### **-name** *user\_name*

(Optional) Specifies the name of the person who is the recipient of email event notifications. The *user\_name* value must be unique, must not contain spaces, and must not contain only numbers. If you

do not specify a user name, the system automatically assigns a user name in the format of `emailuser $n$` , where  $n$  is a number beginning with 0 (`emailuser0`, `emailuser1`, and so on).

The name **emailuser $n$** , where  $n$  is a number, is reserved and cannot be used as one of your user names.

**-address** *user\_address*

(Required) Specifies the email address of the person receiving the email event or inventory notifications, or both. The *user\_address* value must be unique.

**-usertype** **support** | **local**

(Required) Specifies the type of user, either customer or support, based on the following definitions:

**support**

Address of the support organization that provides vendor support.

**local** All other addresses.

**-error on** | **off**

(Optional) Specifies whether the recipient receives error-type event notifications. Set to **on**, error-type event notifications are sent to the email recipient. Set to **off**, error-type event notifications are not sent to the recipient. The default value is **on**.

**-warning on** | **off**

(Optional) Specifies whether the recipient receives warning-type event notifications. Set to **on**, warning-type event notifications are sent to the email recipient. Set to **off**, warning-type event notifications are not sent to the recipient. The default value is **on**.

**-info on** | **off**

(Optional) Specifies whether the recipient receives informational event notifications. Set to **on**, informational event notifications are sent to the email recipient. Set to **off**, informational event notifications are not sent to the recipient. The default value is **on**.

**-inventory on** | **off**

(Optional) Specifies whether this recipient receives inventory email notifications. The default value is **off**.

## Description

This command adds email recipients to the email event and inventory notification facility. You can add up to twelve recipients, one recipient at a time. When an email user is added, if a user name is not specified, a default name is allocated by the system. This default name has the form of `emailuser1`, `emailuser2`, and so on. Email notification starts when you process the **startemail** command.

**Note:** Before the **usertype** parameter can be set to **support**, the **-warning** and **-info** flags must be set to **off**.

### An invocation example

```
mkemailuser -address manager2008@ibm.com -error on -usertype local
```

### The resulting output

```
email user, id [2], successfully created
```

---

## mkxsnmpserver

The **mkxsnmpserver** command creates an SNMP server to receive notifications.

## Syntax

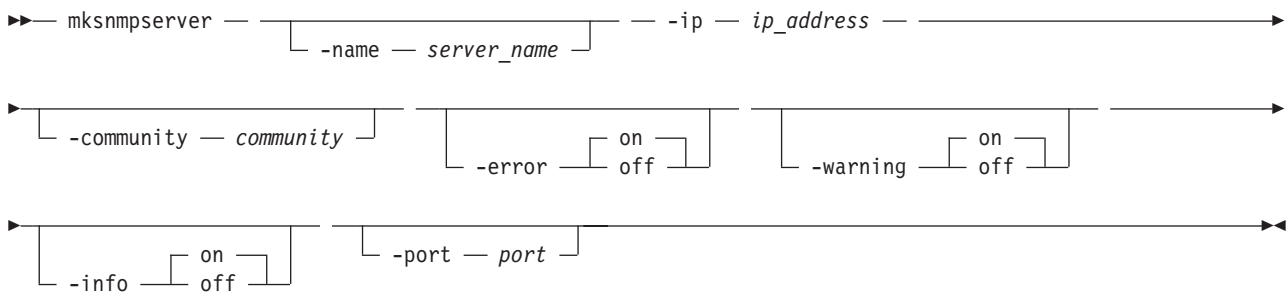

## Parameters

### **-name** *server\_name*

(Optional) Specifies a unique name to assign to the SNMP server. If a name is not specified, then a system default of `snmpn` is applied, where *n* is the ID of the server. When specifying a server name, `snmp` is a reserved word.

### **-ip** *ip\_address*

(Required) Specifies the IP address of the SNMP server. This must be a valid IPv4 or IPv6 address.

### **-community** *community*

(Optional) Specifies the community name for the SNMP server. If you do not specify a community name, then the default name of `public` is used.

### **-error on | off**

(Optional) Specifies whether the server receives error notifications. Set to `on`, error notifications are sent to the SNMP server. Set to `off`, error notifications are not sent to the SNMP server. The default value is `on`.

### **-warning on | off**

(Optional) Specifies whether the server receives warning notifications. Set to `on`, warning notifications are sent to the SNMP server. Set to `off`, warning notifications are not sent to the SNMP server. The default value is `on`.

### **-info on | off**

(Optional) Specifies whether the server receives information notifications. Set to `on`, information notifications are sent to the SNMP server. Set to `off`, information notifications are not sent to the SNMP server. The default value is `on`.

### **-port** *port*

(Optional) Specifies the remote port number for the SNMP server. This must be a value of 1 - 65535. The default value is 162.

## Description

This command creates an SNMP server to receive notifications.

SAN Volume Controller supports a maximum of 6 SNMP servers.

### An invocation example

```
mksnmpserver -ip 2.2.2.2 -port 78
```

### The resulting output

```
SNMP Server id [2] successfully created
```

---

## mksyslogserver

The `mksyslogserver` command creates a syslog server to receive notifications.

### Syntax

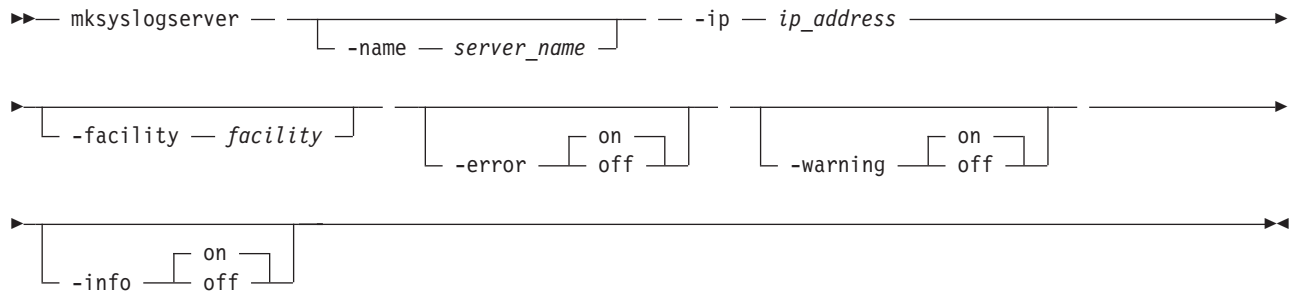

### Parameters

**-name** *server\_name*

(Optional) Specifies a unique name to assign to the syslog server. If a name is not specified, then a system default of `syslogn` is applied, where *n* is the ID of the server. When specifying a server name, `syslog` is a reserved word.

**-ip** *ip\_address*

(Required) Specifies the IP address of the syslog server. This must be a valid IPv4 or IPv6 address.

**-facility** *facility*

(Optional) Specifies the facility number used in syslog messages. This number identifies the origin of the message to the receiving server. Servers configured with facility values of 0 - 3 receive syslog messages in concise format. Servers configured with facility values of 4 - 7 receive syslog messages in fully-expanded format. The default value is 0.

**-error on | off**

(Optional) Specifies whether the server receives error notifications. Set to `on`, error notifications are sent to the syslog server. Set to `off`, error notifications are not sent to the syslog server. The default value is `on`.

**-warning on | off**

(Optional) Specifies whether the server receives warning notifications. Set to `on`, warning notifications are sent to the syslog server. Set to `off`, warning notifications are not sent to the syslog server. The default value is `on`.

**-info on | off**

(Optional) Specifies whether the server receives information notifications. Set to `on`, information notifications are sent to the syslog server. Set to `off`, information notifications are not sent to the syslog server. The default value is `on`.

### Description

This command creates a syslog server to receive notifications. The syslog protocol is a client-server standard for forwarding log messages from a sender to a receiver on an IP network. Syslog can be used to integrate log messages from different types of systems into a central repository.

SAN Volume Controller supports a maximum of 6 syslog servers.

### An invocation example

```
mksyslogserver -ip 1.2.3.4
```

## The resulting output

Syslog Server id [2] successfully created

---

## rmemailserver

The **rmemailserver** command deletes the specified email server object.

### Syntax

```
►►— rmemailserver — email_server_name —————►►
 └─ email_server_id ─┘
```

### Parameters

*email\_server\_name* | *email\_server\_id*

(Required) Specifies the name or ID of the email server object to be deleted.

### Description

Use this command to delete an existing email server object that describes a remote Simple Mail Transfer Protocol (SMTP) email server. You must specify either the current name or the ID of the object returned at creation time. Use the **lserver** command to obtain this ID.

**Note:** Email service stops when the last email server is removed. Use the **startemail** command to reactivate the email and inventory notification function after at least one email server has been configured.

### An invocation example

```
rmemailserver email4
```

### The resulting output

none

---

## rmemailuser

The **rmemailuser** command allows you to remove a previously defined email recipient from your system.

### Syntax

```
►►— rmemailuser — —userid_or_name—————►►
```

### Parameters

*userid\_or\_name*

(Required) Specifies the user ID or user name of the email recipient to remove.

### Description

This command removes an existing email recipient from the system.

### An invocation example

The following example removes email recipient **manager2008**:

```
rmemailuser manager2008
```

### The resulting output

[No feedback]

### An invocation example

The following example removes email recipient 2:

```
rmailtouser 2
```

### The resulting output

[No feedback]

---

## rmsnmpserver

The **rmsnmpserver** command deletes the specified SNMP server.

### Syntax

```
▶▶ rmsnmpserver — [snmp_server_name | snmp_server_id] ▶▶
```

### Parameters

*snmp\_server\_name* | *snmp\_server\_id*

(Required) Specifies the name or ID of the SNMP server to be deleted.

### Description

Use this command to delete an existing SNMP server. You must specify either the current name of the server or the ID returned at creation time. Use the **lssnmpserver** command to obtain this ID.

### An invocation example

```
rmsnmpserver snmp4
```

### The resulting output

none

---

## rmsyslogserver

The **rmsyslogserver** command deletes the specified syslog server.

### Syntax

```
▶▶ rmsyslogserver — [syslog_server_name | syslog_server_id] ▶▶
```

### Parameters

*syslog\_server\_name* | *syslog\_server\_id*

(Required) Specifies the name or ID of the syslog server to be deleted.

### Description

Use this command to delete an existing syslog server. You must specify either the current name of the server or the ID returned at creation time. Use the **lssyslogserver** command to obtain this ID.

### An invocation example

```
rmsyslogserver 2
```

### The resulting output

```
none
```

---

## sendinventoryemail

The **sendinventoryemail** command sends an inventory email notification to all email recipients who are enabled to receive inventory email notifications. There are no parameters for this command.

### Syntax

```
►— sendinventoryemail —◄
```

### Parameters

There are no parameters for this command.

### Description

This command sends an inventory email notification to all email recipients who are enabled to receive inventory email notifications. This command fails if the **startemail** command has not been processed and at least one email recipient using the email event and inventory notification facility has not been set up to receive inventory email notifications. This command also fails if the email infrastructure has not been set up.

### An invocation example

In the following example, you send an inventory email notification to all email recipients who are enabled to receive them:

```
sendinventoryemail
```

### The resulting output

```
[No feedback]
```

---

## startemail

The **startemail** command activates the email and inventory notification function. There are no parameters for this command.

### Syntax

```
►— startemail —◄
```

### Parameters

There are no parameters for this command.

### Description

This command enables the email event notification service. No emails are sent to users until the **startemail** command has been run and at least one user has been defined to the system.



## An invocation example

In the following example, you are starting the email error notification service.

```
startemail
```

## The resulting output

```
[No feedback]
```

---

## stopemail

The **stopemail** command stops the email and inventory notification function. There are no parameters for this command.

## Syntax

```
▶▶— stopemail —————▶▶
```

## Parameters

There are no parameters for this command.

## Description

This command stops the email error notification function. No emails are sent to users until the **startemail** command is reissued.

## An invocation example

In the following example, you have stopped the email and inventory notification function:

```
stopemail
```

## The resulting output

```
[No feedback]
```

---

## testemail

The **testemail** command allows you to send an email notification to one user of the email notification function or to all users of the email notification function to ensure that the function is operating correctly.

## Syntax

```
▶▶— testemail —————▶▶
 ┌──userid_or_name──┐
 └--all--┘
```

## Parameters

*userid\_or\_name*

(Required if you do not specify **-all**) Specifies the user ID or user name of the email recipient that you want to send a test email to. You cannot use this parameter with the **-all** parameter. The *userid\_or\_name* value must not contain spaces.

**-all**

(Required if you do not specify *userid\_or\_name*) Sends a test email to all email users configured to

receive notification of events of any notification type. No attempt is made to send the test email to an email user who does not have any notification setting set to *on*.

## Description

This command sends test emails to the specified email users. The email recipient expects to receive the test email within a specified service time. If the email is not received within the expected time period, the recipient must contact the administrator to ensure that the email settings for the user are correct. If there is still a problem, you must contact the IBM Support Center.

The email recipient uses the test email to check that the SMTP name, the IP address, the SMTP port, and the user address are valid.

## An invocation example

The following example sends a test email to the user ID **manager2008**:

```
testemail manager2008
```

## The resulting output

[No feedback]

---

## Chapter 13. Enclosure commands

**Storwize V7000 only:** Enclosure commands capture information that can assist you with managing enclosures.

---

### addcontrolenclosure

The **addcontrolenclosure** command is used to add control enclosures to the clustered system.

#### Syntax

```
addcontrolenclosure -i iogrp -iogrp io_grp_id_or_name -s sernum enclosure_serial_number
```

#### Parameters

**-iogrp** *io\_grp\_id\_or\_name*

The I/O group in which you want to put the control enclosure.

**-sernum** *enclosure\_serial\_number*

The serial number of the control enclosure you want to add.

#### Description

Use this command to add a control enclosure to the system.

#### An invocation example

```
addcontrolenclosure
```

#### The resulting output

```
Enclosure containing Node, id [x], successfully added
```

---

### chenclosure

Use the **chenclosure** command to modify enclosure properties.

#### Syntax

```
chenclosure [-identify yes|no] [-managed yes|no] [-id enclosure_id]
-enclosure_id
```

#### Parameters

**Note:** Optional parameters are mutually exclusive. Exactly one of the optional parameters must be set.

**-identify** *yes|no*

(Optional) Makes the identify LED start or stop flashing.

**-managed** *yes|no*

(Optional) Makes the enclosure into a managed or unmanaged enclosure.

**-id** *enclosure\_id*  
(Optional) Changes the enclosure ID after you replace the enclosure, and enables you to control what is on the front panel.

*enclosure\_id*  
The enclosure you want to modify.

## Description

Use this command to modify enclosure properties.

**To change the identity of enclosure 7 from 7 to 4:**

```
chenclosure -id 4 7
```

**To change enclosure 1 to *unmanaged*:**

```
chenclosure -managed no 1
```

**To make the identify LED on enclosure 1 stop flashing:**

```
chenclosure -identify no 1
```

---

## chenclosurecanister

Use the **chenclosurecanister** command to modify the properties of an enclosure canister.

## Syntax

```
▶▶ chenclosurecanister [-excludesaport yes|no -port 1|2 -force |
 -identify yes|no]
▶ -canister canister_id enclosure_id ▶▶
```

### Note:

1. The **-port** and **-excludesaport** parameters must be specified together.
2. Exactly one of the optional parameters must be set.

## Parameters

**Note:** Optional parameters are mutually exclusive.

**-identify** *yes|no*  
(Optional) Change the state of fault LED to or from *slow\_flashing*.

**-excludesaport** *yes|no*  
(Optional) Excludes or includes the specified SAS port. You can use the **-force** flag if there are dependent VDIs.

**Note:** Using the **-force** flag might result in loss of access to your data.

**-port** *1 | 2*  
(Optional) The SAS port to include or exclude.

*canister\_id*  
The canister you want to apply the change to.

*enclosure\_id*  
The enclosure that the canister is a member of.

## Description

This command enables you to modify the properties of an enclosure canister.

**To make the fault LED flash on canister 1 of enclosure 3:**

```
chenclosurecanister -identify yes -canister 1 3
```

**To exclude SAS port 1 on canister 2 of enclosure 1:**

```
chenclosurecanister -excludesasport yes -port 1 -canister 2 1
```

---

## chenclosureslot

Use the **chenclosureslot** command to modify the properties of an enclosure slot.

### Syntax

```
►► chenclosureslot -identify—yes|no -exclude—yes|no -port—port_id -force -slot—slot_id
►—enclosure_id
```

### Note:

1. Optional parameters are mutually exclusive.
2. **-port** and **-force** may only be specified if **-exclude** is.
3. Exactly one of the optional parameters must be set.
4. The **-force** flag will only have an effect on the operation of **-exclude yes**.

### Parameters

**-identify** yes|no

Change the state of fault LED to or from *slow\_flashing*.

**-exclude** yes|no

(Optional) Ensures that an enclosure slot port is excluded. The following list gives details of the options you can use with this parameter:

- **-exclude yes -port port\_id -slot slot\_id enclosure\_id**: The port you specify with *port\_id* will be excluded. If the current state of the port is *excluded\_by\_enclosure*, *excluded\_by\_drive*, or *excluded\_by\_cluster*, this command will appear to have no effect. However, if the current state of the port is *online*, then that state will change to *excluded\_by\_cluster*. The port will remain excluded until you rerun this command with *no* selected.

**Attention:** This command will check for dependent volumes. If issuing this command would result in losing access to data, then the command will fail and an error message will display. You can use the **-force** flag to ignore these errors, but this could result in loss of access to data.

- **-exclude no -port port\_id -slot slot\_id enclosure\_id**: The port will be put into *online* state, provided there are no other reasons to exclude the port. If you issue this command when the port is *online*, then it will have no effect. However, if you issue this command when the port is *excluded*, then the port state will do one of the following:
  - Change to *online* status immediately.
  - Change to *online* status after all other reasons for the port to be excluded have been removed.
- **-exclude yes|no -slot slot\_id enclosure\_id**: If you issue this command without defining a port, then the command will simultaneously act on both ports.

- port 1|2**  
(Optional) The port on the canister to be excluded. If it is not specified, *-exclude* will act on both ports.
- slot slot\_id**  
The slot ID.
- enclosure\_id**  
The enclosure that the slot is a member of.

## Description

This command enables you to modify the properties of an enclosure slot.

Turn on the identify LED on slot 7 of enclosure 1:

```
chenclosureslot -identify yes -slot 7 1
```

Force the exclusion of port 1 of slot 7 of enclosure 1:

```
chenclosureslot -exclude yes -port 1 -force -slot 7 1
```

---

## lsenclosure

Use the **lsenclosure** command to view a summary of the enclosures.

### Syntax

```

>> svcinfo — lsenclosure — [enclosure_id] — [-delim — delimiter] —————>>

```

### Parameters

**enclosure\_id**  
Detailed information for the enclosure that you specify.

**-delim delimiter**  
(Optional) By default in a concise view, all columns of data are space-separated. The width of each column is set to the maximum possible width of each item of data. In a detailed view, each item of data has its own row, and if the headers are displayed, the data is separated from the header by a space. The **-delim** parameter overrides this behavior. Valid input for the **-delim** parameter is a one-byte character. If you enter `-delim :` on the command line, the colon character (:) separates all items of data in a concise view; for example, the spacing of columns does not occur. In a detailed view, the data is separated from its header by the specified delimiter.

### Description

This command enables you to view a summary of the enclosures (including current status information for canisters and power and cooling units, and other enclosure attributes). Table 24 shows the possible outputs:

Table 24. *lsenclosure* output

| Attribute | Description              |
|-----------|--------------------------|
| id        | The ID of the enclosure. |

Table 24. `lsenclosure` output (continued)

| Attribute             | Description                                                                                                                                                                                                                                                                                                                                                                                               |
|-----------------------|-----------------------------------------------------------------------------------------------------------------------------------------------------------------------------------------------------------------------------------------------------------------------------------------------------------------------------------------------------------------------------------------------------------|
| status                | Indicates if an enclosure is visible to the SAS network: <ul style="list-style-type: none"> <li>• online: a managed or unmanaged enclosure is visible</li> <li>• offline: a managed enclosure is not visible, and other fields hold their last known values.</li> <li>• degraded: if an enclosure is visible, but not down both strands</li> </ul>                                                        |
| type                  | The type of enclosure: <ul style="list-style-type: none"> <li>• control</li> <li>• expansion</li> </ul>                                                                                                                                                                                                                                                                                                   |
| managed               | Whether the enclosure is managed: <ul style="list-style-type: none"> <li>• yes</li> <li>• no</li> </ul>                                                                                                                                                                                                                                                                                                   |
| IO_group_id           | The I/O group the enclosure belongs to; blank if canisters are connected to two different I/O groups.                                                                                                                                                                                                                                                                                                     |
| IO_group_name         | The I/O group the enclosure belongs to; blank if canisters are connected to two different I/O groups.                                                                                                                                                                                                                                                                                                     |
| fault_LED             | The status of the fault LED on the enclosure: <ul style="list-style-type: none"> <li>• on: a service action is required immediately on the enclosure or a component within the enclosure (including a canister, power unit, or non-spared drive).</li> <li>• slow_flashing: there is insufficient battery power to run I/O</li> <li>• off: there are faults on the enclosure or its components</li> </ul> |
| identify_LED          | The state of the identify LED <ul style="list-style-type: none"> <li>• off: the enclosure is not identified</li> <li>• slow_flashing: the enclosure is being identified</li> </ul>                                                                                                                                                                                                                        |
| error_sequence_number | Indicates the error log number of the highest priority error for this object. This is typically blank; however, if there is a problem (for example, the status has degraded), then it contains the sequence number of that error.                                                                                                                                                                         |
| product_MTM           | The product machine type and model.                                                                                                                                                                                                                                                                                                                                                                       |
| serial_number         | The serial number of the enclosure. This is the product serial number, which indicates the enclosure and its contents. The enclosure has its own serial number, which is embedded in the FRU_identity 11S data.                                                                                                                                                                                           |
| FRU_part_number       | The FRU part number of the enclosure.                                                                                                                                                                                                                                                                                                                                                                     |
| FRU_identity          | The 11S serial number that combines the manufacturing part number and the serial number.                                                                                                                                                                                                                                                                                                                  |
| total_canisters       | The maximum number of canisters for this enclosure type.                                                                                                                                                                                                                                                                                                                                                  |
| online_canisters      | The number of canisters contained in this enclosure that are online.                                                                                                                                                                                                                                                                                                                                      |
| total_PSUs            | The number of power and cooling units in this enclosure.                                                                                                                                                                                                                                                                                                                                                  |
| online_PSUs           | The number of PSUs contained in this enclosure that are online.                                                                                                                                                                                                                                                                                                                                           |
| drive_slots           | The number of drive slots in the enclosure.                                                                                                                                                                                                                                                                                                                                                               |

### An invocation example

```
svcinfo lsenclosure -delim :
```

### The resulting output

id:status:type:managed:IO\_group\_id:IO\_group\_name:product\_MTM:serial\_number:total\_canisters:online\_canisters:  
total\_PSUs:online\_PSUs:drive\_slots1:degraded:expansion:no:0:io\_grp0:2076-224:66G0083:2:2:2:24

## lsenclosurebattery

Use the **lsenclosurebattery** command to display information about the batteries in the enclosure PSUs.

### Syntax

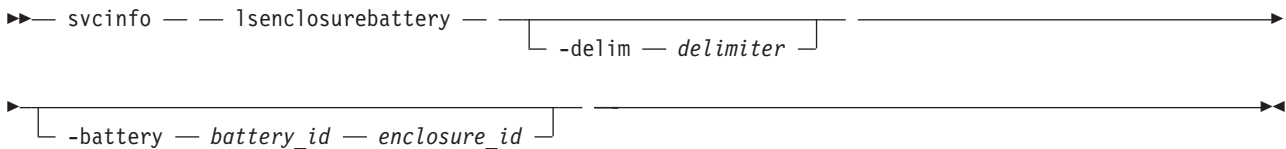

### Parameters

*enclosure\_id*

(Optional) Lists the batteries for the specified enclosure.

**-battery** *battery\_id*

(Optional) Provides a detailed view of the specified enclosure battery. Valid only when an enclosure is specified.

**-delim** *delimiter*

(Optional) By default in a concise view, all columns of data are space-separated. The width of each column is set to the maximum possible width of each item of data. In a detailed view, each item of data has its own row, and if the headers are displayed, the data is separated from the header by a space. The **-delim** parameter overrides this behavior. Valid input for the **-delim** parameter is a one-byte character. If you enter **-delim :** on the command line, the colon character (:) separates all items of data in a concise view; for example, the spacing of columns does not occur. In a detailed view, the data is separated from its header by the specified delimiter.

### Description

This command displays information about the batteries in the enclosure PSUs. The concise view will show a line for each battery slot in every control enclosure, regardless of whether they exist. Batteries will not be shown for expansion enclosures. Table 25 shows possible outputs.

Table 25. *lsenclosurebattery* outputs

| Attribute       | Description                                                                                                                                                                                                                                                                                   |
|-----------------|-----------------------------------------------------------------------------------------------------------------------------------------------------------------------------------------------------------------------------------------------------------------------------------------------|
| enclosure_id    | The identity of the enclosure that contains the battery.                                                                                                                                                                                                                                      |
| battery_id      | Identifies the battery in the enclosure.                                                                                                                                                                                                                                                      |
| status          | The status of the battery: <ul style="list-style-type: none"> <li>• online: the battery is present and working as usual</li> <li>• degraded: the battery is present but not working as usual</li> <li>• offline: the battery could not be detected</li> </ul>                                 |
| charging_status | The charging state of the battery: <ul style="list-style-type: none"> <li>• idle: the battery is not charging nor discharging</li> <li>• charging: the battery is charging</li> <li>• reconditioning: the battery is reconditioning itself, by being discharged and then recharged</li> </ul> |



Table 25. *lsenclosurebattery* outputs (continued)

| Attribute             | Description                                                                                                                                                                                                                                           |
|-----------------------|-------------------------------------------------------------------------------------------------------------------------------------------------------------------------------------------------------------------------------------------------------|
| recondition_needed    | The battery needs to be reconditioned; however, this cannot be done because of one or more errors.                                                                                                                                                    |
| percent_charged       | Indicates the charge of battery, in a percentage.                                                                                                                                                                                                     |
| end_of_life_warning   | The battery is reaching its end of life warning, and will need to be replaced: <ul style="list-style-type: none"> <li>• yes</li> <li>• no</li> </ul>                                                                                                  |
| FRU_part_number       | The FRU part number of the battery.                                                                                                                                                                                                                   |
| FRU_identity          | The 11S number, combining the manufacturing part number and the serial number.                                                                                                                                                                        |
| firmware_level        | The battery firmware version.                                                                                                                                                                                                                         |
| error_sequence_number | Indicates the error log (or event log) number of the highest priority error for this object. This is typically blank; however, if there is a problem (for example, the status is degraded), then it contains the sequence number of that error event. |

### An invocation example

```
svcinfo lsenclosurebattery -delim :
```

### The resulting output

```
enclosure_id:battery_id:status:charging_status:recondition_needed:percent_charged:end_of_life_warning
1:1:offline:idle:no:0:no
1:2:offline:idle:no:0:no
```

## | **lscontrolenclosurecandidate**

| The **lscontrolenclosurecandidate** command displays a list of all control enclosures that you can add to the current system.

### | **Syntax**

```
| ►► lscontrolenclosurecandidate ◀◀
```

### | **Parameters**

| None.

### | **Description**

| Table 26 provides the possible values that are applicable to the attributes that are displayed as data in the output views.

| *Table 26. lscontrolenclosurecandidate attribute values*

| Attribute     | Value                                |
|---------------|--------------------------------------|
| serial_number | The serial number for the enclosure. |
| product_MTM   | The MTM for the enclosure.           |

### | **A concise invocation example**

```
| lscontrolenclosurecandidate
```

## | The concise resulting output

```
| serial_number product_MTM
| G00F7GY 2076-124
```

---

## lsenclosurecanister

Use the **lsenclosurecanister** command to view a detailed status for each canister in an enclosure.

### Syntax

```
▶▶ svcinfo — lsenclosurecanister —————▶
 | enclosure_id |
 | -canister — canister_id |

▶ | -delim — delimiter | ◀◀
```

### Parameters

*enclosure\_id*

Lists the canisters for the specified enclosure.

**-canister** *canister\_id*

Valid only when the *enclosure\_id* is specified. Provides a detailed view of the canister for the specified enclosure.

**-delim** *delimiter*

(Optional) By default in a concise view, all columns of data are space-separated. The width of each column is set to the maximum possible width of each item of data. In a detailed view, each item of data has its own row, and if the headers are displayed, the data is separated from the header by a space. The **-delim** parameter overrides this behavior. Valid input for the **-delim** parameter is a one-byte character. If you enter **-delim :** on the command line, the colon character (:) separates all items of data in a concise view; for example, the spacing of columns does not occur. In a detailed view, the data is separated from its header by the specified delimiter.

### Description

This command enables you to view a detailed status for each canister in an enclosure. Table 27 shows the possible outputs:

Table 27. *lsenclosurecanister* output

| Attribute    | Description                                                                                                                                                                                                                                                     |
|--------------|-----------------------------------------------------------------------------------------------------------------------------------------------------------------------------------------------------------------------------------------------------------------|
| enclosure_id | The identity of the enclosure that contains the canister.                                                                                                                                                                                                       |
| canister_id  | Identifies which of the canisters in the enclosure this is.                                                                                                                                                                                                     |
| status       | The status of the canister: <ul style="list-style-type: none"><li>• online: the canister is present and working normally.</li><li>• degraded: the canister is present but not working normally</li><li>• offline: the canister could not be detected.</li></ul> |
| type         | The type of canister: <ul style="list-style-type: none"><li>• node</li><li>• expansion</li></ul>                                                                                                                                                                |
| node_id      | The node that corresponds to this canister; blank if the canister is not a node, or if the node is not part of the cluster.                                                                                                                                     |

Table 27. `lsenclosurecanister` output (continued)

| Attribute             | Description                                                                                                                                                                                                                                                                                                                                                                                                                     |
|-----------------------|---------------------------------------------------------------------------------------------------------------------------------------------------------------------------------------------------------------------------------------------------------------------------------------------------------------------------------------------------------------------------------------------------------------------------------|
| node_name             | The node that corresponds to this canister; blank if the canister is not a node, or if the node is not part of the cluster.                                                                                                                                                                                                                                                                                                     |
| FRU_part_number       | The FRU part number of the canister.                                                                                                                                                                                                                                                                                                                                                                                            |
| FRU_identity          | The 11S number that combines the manufacturing part number and the serial number.                                                                                                                                                                                                                                                                                                                                               |
| WWNN                  | The Fibre Channel WWNN of the canister (node canisters only).                                                                                                                                                                                                                                                                                                                                                                   |
| firmware_level        | The firmware level of the SCSI Enclosure Services (SES) code running on the canister.                                                                                                                                                                                                                                                                                                                                           |
| temperature           | (0 to 245) The temperature of the canister (in degrees Celsius). If the temperature goes below 0, 0 will be displayed.                                                                                                                                                                                                                                                                                                          |
| fault_LED             | The state of the combined fault and identify LEDs: <ul style="list-style-type: none"> <li>• off: no fault</li> <li>• slow_flashing: identify mode</li> </ul> <p><b>Note:</b> When the LED is in identify mode, it conceals whether there is a fault present, because it always flashes. When you remove it from identity mode, the LED will become on or off.</p> <ul style="list-style-type: none"> <li>• on: fault</li> </ul> |
| SES_status            | The SCSI status of the connection between the device and the canister: <ul style="list-style-type: none"> <li>• online</li> <li>• offline</li> </ul>                                                                                                                                                                                                                                                                            |
| error_sequence_number | Indicates the error log number of the highest priority error for this object. This is typically blank; however, if there is a problem (for example, the status is degraded), then it contains the sequence number of that error.                                                                                                                                                                                                |
| SAS_port_1_status     | Indicates if there is damage to the cable between SAS ports: <ul style="list-style-type: none"> <li>• online</li> <li>• offline</li> <li>• excluded: are logged in, but cannot communicate with the canister</li> <li>• degraded: the SAS cable not fully functional</li> </ul>                                                                                                                                                 |
| SAS_port_2_status     | Indicates if there is damage to the cable between SAS ports: <ul style="list-style-type: none"> <li>• online</li> <li>• offline</li> <li>• excluded: are logged in, but cannot communicate with the canister</li> <li>• degraded: the SAS cable not fully functional</li> </ul>                                                                                                                                                 |

### An invocation example

```
svcinfolenclosurecanister -delim :
```

### The resulting output

```
enclosure_id:canister_id:status:type:node_id:node_name
1:1:degraded:expansion:1:node1
```

### A detailed example

```
svcinfolenclosurecanister -canister 1 1
```

### The resulting output

```
enclosure_id 1
canister_id 1
status online
type node
node_id 1
```

```

node_name node1
FRU_part_number AAAAAAA
FRU_identity 11S1234567Y12345678901
WWNN 5005076801005F94
firmware_level XXXXXXXXXX
temperature 23
fault_LED flashing
SES_status online
error_sequence_number
SAS_port_1_status online
SAS_port_2_status online

```

## lsenclosurepsu

Use the **lsenclosurepsu** command to view information about each power-supply unit (PSU) in the enclosure.

### Syntax

```

>> svcinfo — lsenclosurepsu — [-psu — psu_id — enclosure_id]
[-delim — delimiter]

```

### Parameters

*enclosure\_id*

(Optional) Lists the PSUs for the specified enclosure.

**-psu** *psu\_id*

(Optional) Valid only when the **enclosure\_id** is specified. Provides a detailed view of the PSU for the specified enclosure.

**-delim** *delimiter*

(Optional) By default in a concise view, all columns of data are space-separated. The width of each column is set to the maximum possible width of each item of data. In a detailed view, each item of data has its own row, and if the headers are displayed, the data is separated from the header by a space. The **-delim** parameter overrides this behavior. Valid input for the **-delim** parameter is a one-byte character. If you enter **-delim :** on the command line, the colon character (:) separates all items of data in a concise view; for example, the spacing of columns does not occur. In a detailed view, the data is separated from its header by the specified delimiter.

### Description

This command enables you to view information about each power-supply unit (PSU) in the enclosure. Table 28 shows the possible outputs:

Table 28. *lsenclosurepsu* output

| Attribute    | Description                                                                                                                                                                                                                                                              |
|--------------|--------------------------------------------------------------------------------------------------------------------------------------------------------------------------------------------------------------------------------------------------------------------------|
| enclosure_id | The ID of the enclosure containing the PSU.                                                                                                                                                                                                                              |
| psu_id       | The ID of the PSU in the enclosure.                                                                                                                                                                                                                                      |
| status       | The status of the power and cooling unit in the enclosure: <ul style="list-style-type: none"> <li>• online: a PSU is present and working normally</li> <li>• offline: a PSU cannot be detected</li> <li>• degraded: a PSU is present but not working normally</li> </ul> |

Table 28. `lsenclosurepsu` output (continued)

| Attribute             | Description                                                                                                                                                                                                                                                                                                                                                                                     |
|-----------------------|-------------------------------------------------------------------------------------------------------------------------------------------------------------------------------------------------------------------------------------------------------------------------------------------------------------------------------------------------------------------------------------------------|
| AC_failed             | <ul style="list-style-type: none"> <li>on: If the AC, DC, and fan LEDs are all on, then there is a PSU fault. If only the AC LED is on, then there is no AC power.</li> <li>off: The AC power is OK.</li> </ul>                                                                                                                                                                                 |
| DC_failed             | <ul style="list-style-type: none"> <li>on: If the AC, DC, and fan LEDs are all on, then there is a PSU fault. If only the DC LED is on, then there is no DC power.</li> <li>off: The DC power is OK.</li> </ul>                                                                                                                                                                                 |
| fan_failed            | <ul style="list-style-type: none"> <li>on: If the AC, DC, and fan LEDs are all on, then there is a PSU fault. If only the fan LED is on, then there is a fan failure.</li> <li>off: The fans in this PSU are OK.</li> </ul>                                                                                                                                                                     |
| redundant             | Indicates if you can remove this power supply: <ul style="list-style-type: none"> <li>If the PSU is on an expansion enclosure, then the other PSU must be online.</li> <li>If the PSU is on a control enclosure, then the other PSU must be online, and the battery on that PSU must contain enough charge to allow the canisters to dump state and cache data before shutting down.</li> </ul> |
| error_sequence_number | Indicates the error log (or event log) number of the highest priority error for this object. This is typically blank; however, if there is a problem (for example, the status is degraded), then it contains the sequence number of that error event.                                                                                                                                           |
| FRU_part_number       | The FRU part number of the PSU.                                                                                                                                                                                                                                                                                                                                                                 |
| FRU_identity          | The 11S number, combining the manufacturing part number and the serial number.                                                                                                                                                                                                                                                                                                                  |

### An invocation example

```
svcinfolenclosurepsu -delim :
```

### The resulting output

```
enclosure_id:PSU_id:status
1:1:degraded
```

## lsenclosureslot

Use the `lsenclosureslot` command to view information about each drive slot in the enclosure.

### Syntax

```
svcinfolenclosureslot enclosure_id [-slot slot_id] [-delim delimiter]
```

### Parameters

*enclosure\_id*

(Optional) Lists slots for that enclosure.

**-slot** *slot\_id*

Valid only when an enclosure is specified. Gives detailed view for that enclosure slot.

**-delim** *delimiter*

(Optional) By default in a concise view, all columns of data are space-separated. The width of each

column is set to the maximum possible width of each item of data. In a detailed view, each item of data has its own row, and if the headers are displayed, the data is separated from the header by a space. The **-delim** parameter overrides this behavior. Valid input for the **-delim** parameter is a one-byte character. If you enter `-delim :` on the command line, the colon character (:) separates all items of data in a concise view; for example, the spacing of columns does not occur. In a detailed view, the data is separated from its header by the specified delimiter.

## Description

This command enables you to view information about each drive slot in the enclosure, such as whether a drive is present, and the port status for that drive. Table 29 shows the possible outputs:

Table 29. `lsenclosureslot` output

| Attribute             | Description                                                                                                                                                                                                                                                                                                                                                                                                                     |
|-----------------------|---------------------------------------------------------------------------------------------------------------------------------------------------------------------------------------------------------------------------------------------------------------------------------------------------------------------------------------------------------------------------------------------------------------------------------|
| enclosure_id          | The identity of the enclosure which contains the drive slot.                                                                                                                                                                                                                                                                                                                                                                    |
| slot_id               | Identifies which of the drive slots in the enclosure this is.                                                                                                                                                                                                                                                                                                                                                                   |
| port_1_status         | The status of enclosure slot port 1. If the port is bypassed for multiple reasons, only one is shown. In order of priority, they are: <ul style="list-style-type: none"> <li>• online: enclosure slot port 1 is online</li> <li>• excluded_by_drive: the drive excluded the port</li> <li>• excluded_by_enclosure: the enclosure excluded the port</li> <li>• excluded_by_cluster: the cluster has excluded the port</li> </ul> |
| port_2_status         | The status of enclosure slot port 2. If the port is bypassed for multiple reasons, only one is shown. In order of priority, they are: <ul style="list-style-type: none"> <li>• online: enclosure slot port 2 is online</li> <li>• excluded_by_drive: the drive excluded the port</li> <li>• excluded_by_enclosure: the enclosure excluded the port</li> <li>• excluded_by_cluster: the cluster has excluded the port</li> </ul> |
| fault_LED             | The state of the combined fault and identify LEDs: <ul style="list-style-type: none"> <li>• off: no fault</li> <li>• slow_flashing: identify mode</li> </ul> <p><b>Note:</b> When the LED is in identify mode, it conceals whether there is a fault present, because it always flashes. When you remove it from identity mode, the LED will become on or off.</p> <ul style="list-style-type: none"> <li>• on: fault</li> </ul> |
| powered               | Indicates whether the slot is powered on. <ul style="list-style-type: none"> <li>• yes</li> <li>• no</li> </ul>                                                                                                                                                                                                                                                                                                                 |
| drive_present         | Indicates if a drive is in the slot. The drive can be working, dead, or powered off. <ul style="list-style-type: none"> <li>• yes (present)</li> <li>• no (empty)</li> </ul>                                                                                                                                                                                                                                                    |
| drive_id              | The ID of the drive in the slot; blank if there is no drive present, or if there is a drive present but it is offline and unmanaged.                                                                                                                                                                                                                                                                                            |
| error_sequence_number | Indicates the error log number of the highest priority error for this object. This is typically blank; however, if there is a problem (for example, the status is degraded), then it contains the sequence number of that error.                                                                                                                                                                                                |

### An invocation example

```
svcinfolenclosureslot -delim :
```

## The resulting output

```
enclosure_id:slot_id:port_1_status:port_2_status:drive_present:drive_id
1:1:online:online:yes:22
1:2:online:online:yes:23
1:3:online:online:yes:19
1:4:online:online:yes:7
1:5:online:online:yes:10
1:6:online:online:yes:18
1:7:online:online:yes:20
1:8:online:online:yes:16
1:9:online:online:yes:12
1:10:online:online:yes:11
1:11:online:online:yes:21
1:12:online:online:yes:9
1:13:online:online:yes:14
1:14:online:online:yes:5
1:15:online:online:yes:15
1:16:online:online:yes:13
1:17:online:online:yes:6
1:18:online:online:yes:17
1:19:online:online:yes:4
1:20:online:online:yes:1
1:21:online:online:yes:8
1:22:online:online:yes:0
1:23:online:online:yes:3
1:24:online:online:yes:2
```

---

## triggerenclosedump

Use the **triggerenclosedump** command to force the specified enclosure or enclosures to dump data.

### Syntax

```
▶▶— triggerenclosedump —————▶▶
 -port port_id -iogrp iogrp_id_or_name
 -enclosure enclosure_id
```

### Note:

1. You can only use one of the optional parameters (**-port** or **-enclosure**).
2. If **-port** is specified, **-iogrp** must also be specified.
3. If **-iogrp** is specified, **-port** must also be specified.

### Parameters

**-port** *port\_id*

If the system is wired correctly, this value is identical to the ID of the chain with the enclosures you want to dump. If the system is wired incorrectly, all the enclosures connected to port *port\_id* of either node canister will be dumped.

**-iogrp** *iogrp\_id\_or\_name*

The ID or name of the I/O group the control enclosure belongs to.

**-enclosure** *enclosure\_id*

The ID of the enclosure you want to dump.

### Description

This command requests the canisters in the enclosure or enclosures specified to dump data. The dumped data is subsequently collected and moved to `/dumps/enclosure` on the nodes that are connected to the enclosure. There will be one file for each canister successfully dumped and they may be located on

different nodes. Dumps are for use by IBM support, which has the tools to interpret the dump data. Use the `cpdumps` command to copy the files from the system. This command does not disrupt access to the enclosures.

**To trigger enclosure dumps from all enclosures connected to port 1 of the control enclosure in *iogrp* 2:**

```
triggerenclosuredump -port 1 -iogrp 2
```

**To trigger enclosure dumps from enclosure 5:**

```
triggerenclosuredump -enclosure 5
```



---

## Chapter 14. Licensing commands

The following commands enable you to work with SAN Volume Controller licensed functions.

- **chlicense**
- **dumpinternallog**

---

### chlicense

The **chlicense** command changes license settings for cluster features.

#### Syntax

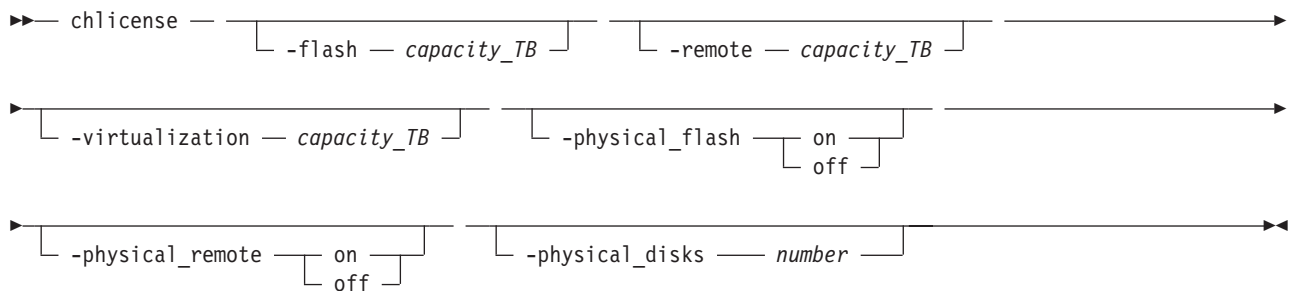

#### Parameters

**-flash** *capacity\_TB*

(Optional) Changes cluster licensing for the FlashCopy feature. To change the licensed capacity for the FlashCopy feature, specify a capacity in terabytes (TB).

**Note:** Only use the optional **flash** parameter with the SAN Volume Controller.

**-remote** *capacity\_TB*

(Optional) Changes cluster licensing for the Metro Mirror and Global Mirror feature. To change the licensed capacity for the Metro Mirror and Global Mirror feature, specify a capacity in terabytes (TB).

**Note:** For Storwize V7000, specify the total number of internal and external enclosures that you have licensed on your system. You must have a Remote Mirroring license for all enclosures.

**-virtualization** *capacity\_TB*

(Optional) Changes cluster licensing for the Virtualization feature. To change the licensed capacity for the Virtualization feature, specify a capacity in terabytes (TB).

**Note:** For Storwize V7000, specify the number of enclosures of external storage that you have been authorized by IBM to use.

**-physical\_flash** **on** | **off**

(Optional) For physical disk licensing, enables or disables the FlashCopy feature. The default value is **off**.

**-physical\_remote** **on** | **off**

(Optional) For physical disk licensing, enables or disables the Metro Mirror and Global Mirror feature. The default value is **off**.

### **-physical\_disks** *number*

(Optional) Changes the licensed settings of the cluster for physical disk licensing. Enter the number of physical disks that your cluster is licensed to manage. The correct number is identified in your license.

#### **Note:**

- If the **-physical\_disks** value is set to zero, the **-physical\_flash** and **-physical\_remote** values are turned off.
- If the **-physical\_disks** value is nonzero, the **-flash**, **-remote**, and **-virtualization** values cannot be set.
- If the **-flash**, **-remote**, or **-virtualization** values are nonzero, the **-physical\_flash**, **-physical\_remote**, and **-physical\_disks** values cannot be set.
- If the **-physical\_disks** value is nonzero, only the FlashCopy and RemoteCopy usage is monitored and appropriate error messages are logged.

## **Description**

The **chlicense** command changes license settings for the cluster. Any change that is made is logged as an event in the license setting log.

For Storwize V7000, the enclosure license already includes virtualization of internal drives on your system. You can use this command to set any additional options. The total amounts for your cluster or clusters must not exceed the total capacity authorization that you have obtained from IBM.

For SAN Volume Controller the default is to have no copy services functions licensed, but this does not stop you from creating and using Copy Services. However, errors are placed in the license settings log that state that you are using an unlicensed feature. The command-line tool return code also notifies you that you are using an unlicensed feature.

For Storwize® V7000, the default is to have no Metro Mirror or Global Mirror function licensed, but this does not stop you from creating and using Copy Services. However, errors are placed in the license settings log that state that you are using an unlicensed feature. The command-line tool return code also notifies you that you are using an unlicensed feature.

The total virtualized capacity can also be modified with this command. This is the number of terabytes (TB) of virtual disk capacity that can be configured by the cluster.

When you reach 90% capacity, any attempt to create or extend Virtual Disks, Relationships, or Mappings results in a message from the command-line tool. This does not stop you from creating and expanding Virtual Disks, Relationships, or Mappings. When usage reaches or exceeds 100% capacity, errors are placed in the license settings log.

Any error that is placed in the license settings log results in a generic error being placed in the cluster error log. This occurs when you issue a command that violates the license agreement. The return code also notifies you that you are violating the license settings.

### **An invocation example**

```
chlicense -remote 5
```

### **The resulting output**

No feedback

---

## dumpinternallog

The **dumpinternallog** command dumps the contents of the license settings error and event log to a file on the current configuration node.

### Syntax

▶▶— dumpinternallog —▶▶

### Description

This command dumps the contents of the internal license settings error and event log to a file on the current configuration node.

This file is always called **feature.txt** and is created, or overwritten, in the **/dumps/feature** directory on the configuration node.

This file can be requested by IBM service personnel.

Before making any entries, the license settings log contains only zeros. A dump of this log from the **dumpinternallog** command results in an empty file.

### An invocation example

```
dumpinternallog
```

### The resulting output

No feedback



---

## Chapter 15. IBM FlashCopy commands

The following commands enable you to work with FlashCopy methods and functions with the SAN Volume Controller.

---

### chfconsistgrp

The **chfconsistgrp** command changes the name of a consistency group or marks the group for auto-deletion.

#### Syntax

```
▶▶ chfconsistgrp [-name new_name_arg] [-autodelete on | off]
▶ [fc_consist_group_id | fc_consist_group_name]
```

#### Parameters

**-name *new\_name\_arg***

(Optional) Specifies the new name to assign to the consistency group.

**-autodelete *on | off***

(Optional) Deletes the consistency group when the last mapping that it contains is deleted or removed from the consistency group.

*fc\_consist\_group\_id* | *fc\_consist\_group\_name*

(Required) Specifies the ID or existing name of the consistency group that you want to modify.

#### Description

The **chfconsistgrp** command changes the name of a consistency group, marks the group for auto-deletion, or both.

#### An invocation example

```
chfconsistgrp -name testgrp1 fcconsistgrp1
```

#### The resulting output

No feedback

---

### chfcmap

The **chfcmap** command modifies attributes of an existing mapping.

#### Syntax

```
▶▶ chfcmap [-name new_name_arg] [-force]
```

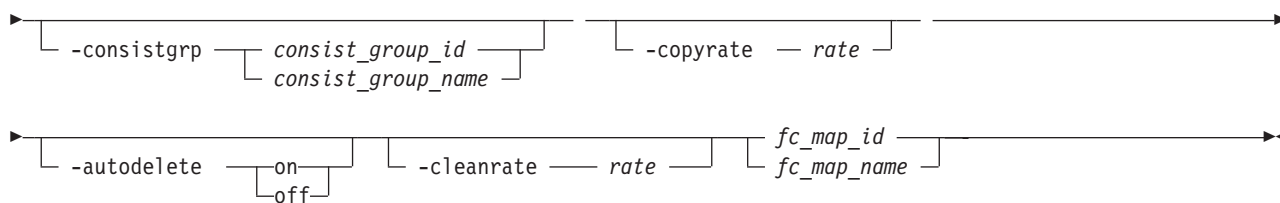

## Parameters

### **-name** *new\_name\_arg*

(Optional) Specifies the new name to assign to the mapping. The **-name** parameter cannot be used with any other optional parameters.

### **-force**

(Optional) Specifies that the mapping be modified to a stand-alone mapping (equivalent to creating the mapping without a consistency group ID). You cannot specify the **-force** parameter with the **-consistgrp** parameter.

### **-consistgrp** *consist\_group\_id* | *consist\_group\_name*

(Optional) Specifies the consistency group for which you want to modify the mapping. You cannot specify the **-consistgrp** parameter with the **-force** parameter.

**Note:** The consistency group cannot be modified if the specified consistency group is in the **preparing**, **prepared**, **copying**, **suspended**, or **stopping** state.

### **-copyrate** *rate*

(Optional) Specifies the copy rate. The *rate* value can be 0 - 100. The default value is 50. A value of 0 indicates no background copy process. For the supported **-copyrate** values and their corresponding rates, see Table 30 on page 183.

### **-autodelete** **on** | **off**

(Optional) Specifies that the autodelete function be turned on or off for the specified mapping. When you specify the **-autodelete on** parameter, you are deleting a mapping after the background copy completes. If the background copy is already complete, the mapping is deleted immediately.

### **-cleanrate** *rate*

(Optional) Sets the cleaning rate for the mapping. The *rate* value can be 0 - 100. The default value is 50.

### *fc\_map\_id* | *fc\_map\_name*

(Required) Specifies the ID or name of the mapping to modify. Enter the ID or name last on the command line.

## Description

The **chfcmap** command modifies attributes of an existing mapping.

**Attention:** You must enter the *fc\_map\_id* | *fc\_map\_name* last on the command line.

If you have created several FlashCopy mappings for a group of VDisks that contain elements of data for the same application, you can assign these mappings to a single FlashCopy consistency group. You can then issue a single prepare command and a single start command for the whole group, for example, so that all of the files for a particular database are copied at the same time.

The **copyrate** parameter specifies the copy rate. If 0 is specified, background copy is disabled. The **cleanrate** parameter specifies the rate for cleaning the target VDisk. The cleaning process is only active if the mapping is in the **copying** state and the background copy has completed, the mapping is in the **copying** state and the background copy is disabled, or the mapping is in the **stopping** state. You can

disable cleaning when the mapping is in the **copying** state by setting the **cleanrate** parameter to 0. If the **cleanrate** is set to 0, the cleaning process runs at the default rate of 50 when the mapping is in the **stopping** state to ensure that the stop operation completes.

Table 30 provides the relationship of the copy *rate* and cleaning *rate* values to the attempted number of grains to be split per second. A grain is the unit of data represented by a single bit.

Table 30. Relationship between the rate, data rate and grains per second values

| User-specified <i>rate</i> attribute value | Data copied/sec | 256 KB grains/sec | 64 KB grains/sec |
|--------------------------------------------|-----------------|-------------------|------------------|
| 1 - 10                                     | 128 KB          | 0.5               | 2                |
| 11 - 20                                    | 256 KB          | 1                 | 4                |
| 21 - 30                                    | 512 KB          | 2                 | 8                |
| 31 - 40                                    | 1 MB            | 4                 | 16               |
| 41 - 50                                    | 2 MB            | 8                 | 32               |
| 51 - 60                                    | 4 MB            | 16                | 64               |
| 61 - 70                                    | 8 MB            | 32                | 128              |
| 71 - 80                                    | 16 MB           | 64                | 256              |
| 81 - 90                                    | 32 MB           | 128               | 512              |
| 91 - 100                                   | 64 MB           | 256               | 1024             |

### An invocation example

```
chfcmap -name testmap 1
```

### The resulting output

No feedback

---

## mkfcconsistgrp

The **mkfcconsistgrp** command creates a new FlashCopy consistency group and identification name.

### Syntax

```

>>> mkfcconsistgrp -- [-name — consist_group_name] [-autodelete]

```

### Parameters

**-name** *consist\_group\_name*

(Optional) Specifies a name for the consistency group. If you do not specify a consistency group name, a name is automatically assigned to the consistency group. For example, if the next available consistency group ID is id=2, the consistency group name is fccstgrp2.

**-autodelete**

(Optional) Deletes the consistency group when the last mapping that it contains is deleted or removed from the consistency group.

### Description

This command creates a new consistency group and identification name. The ID of the new group is displayed when the command process completes.

If you have created several FlashCopy mappings for a group of VDisks that contain elements of data for the same application, you might find it convenient to assign these mappings to a single FlashCopy consistency group. You can then issue a single prepare command and a single start command for the whole group, for example, so that all of the files for a particular database are copied at the same time.

### An invocation example

```
mkfcconsistgrp
```

### The resulting output

```
FlashCopy Consistency Group, id [1], successfully created
```

## mkfcmap

The **mkfcmap** command creates a new FlashCopy mapping, which maps a source VDisk (volume) to a target VDisk (volume) for subsequent copying.

### Syntax

```

mkfcmap -- -source [src_vdisk_id | src_vdisk_name] -- -target [target_vdisk_id | target_vdisk_name]
[-name new_name_arg] [-consistgrp [consist_group_id | consist_group_name]]
[-copyrate rate] [-autodelete] [-grainsize [64 | 256]] [-incremental]
[-cleanrate rate] [-iogrp [iogroup_name | iogroup_id]]

```

### Parameters

- source** *src\_vdisk\_id* | *src\_vdisk\_name*  
(Required) Specifies the ID or name of the source VDisk (volume).
- target** *target\_vdisk\_id* | *target\_vdisk\_name*  
(Required) Specifies the ID or name of the target VDisk (volume).
- name** *new\_name\_arg*  
(Optional) Specifies the name to assign to the new mapping.
- consistgrp** *consist\_group\_id* | *consist\_group\_name*  
(Optional) Specifies the consistency group to add the new mapping to. If you do not specify a consistency group, the mapping is treated as a stand-alone mapping.
- copyrate** *rate*  
(Optional) Specifies the copy rate. The *rate* value can be 0 - 100. The default value is 50. A value of 0 indicates no background copy process. For the supported **-copyrate** values and their corresponding rates, see Table 31 on page 186.
- autodelete**  
(Optional) Specifies that a mapping be deleted when the background copy completes. The default, which applies if this parameter is not entered, is that **autodelete** is set to off.



**-grainsize 64 | 256**

(Optional) Specifies the grain size for the mapping. The default value is 256. Once set, this value cannot be changed.

**-incremental**

(Optional) Marks the FlashCopy mapping as an incremental copy. The default is nonincremental. Once set, this value cannot be changed.

**-cleanrate rate**

(Optional) Sets the cleaning rate for the mapping. The *rate* value can be 0 - 100. The default value is 50.

**-iogrp iogroup\_name | iogroup\_id**

(Optional) Specifies the I/O group for the FlashCopy bitmap. Once set, this value cannot be changed. The default I/O group is either the source VDisk (volume), if a single target map, or the I/O group of the other FlashCopy mapping to which either the source or target VDIsks (volumes) belong.

**Note:** If not enough bitmap space is available to complete this command, more space will automatically be allocated in the bitmap memory (unless you have already reached the maximum bitmap memory).

## Description

This command creates a new FlashCopy mapping. This mapping persists until it is manually deleted, or until it is automatically deleted when the background copy completes and the **autodelete** parameter set to **on**. The source and target VDIsks (volumes) must be specified on the **mkfcmap** command. The **mkfcmap** command fails if the source and target VDIsks (volumes) are not identical in size. Issue the **lsvdisk -bytes** command to find the exact size of the source VDisk (volume) for which you want to create a target disk of the same size. The target VDisk (volume) that you specify cannot be a target VDisk (volume) in an existing FlashCopy mapping. A mapping cannot be created if the resulting set of connected mappings exceeds 256 connected mappings.

The mapping can optionally be given a name and assigned to a consistency group, which is a group of mappings that can be started with a single command. These are groups of mappings that can be processed at the same time. This enables multiple VDIsks (volumes) to be copied at the same time, which creates a consistent copy of multiple disks. This consistent copy of multiple disks is required by some database products in which the database and log files reside on different disks.

If the specified source and target VDIsks (volumes) are the target and source VDIsks (volumes), respectively, of an existing mapping, then the mapping being created and the existing mapping become partners. If one mapping is created as incremental, then its partner is automatically incremental. A mapping can have only one partner.

- | You can create a FlashCopy mapping in which the target VDisk (volume) is a member of a Metro Mirror
- | or Global Mirror relationship, unless one of the following conditions applies:
- | • The relationship is with a clustered system that is running an earlier code level.
- | • The I/O group for the mapping is different than the I/O group for the proposed mapping target VDisk
- | (volume).

The **copyrate** parameter specifies the copy rate. If 0 is specified, background copy is disabled. The **cleanrate** parameter specifies the rate for cleaning the target VDisk (volume). The cleaning process is only active if the mapping is in the copying state and the background copy has completed, the mapping is in the copying state and the background copy is disabled, or the mapping is in the stopping state. You can disable cleaning when the mapping is in the copying state by setting the **cleanrate** parameter to 0. If the **cleanrate** is set to 0, the cleaning process runs at the default rate of 50 when the mapping is in the stopping state to ensure that the stop operation completes.

Table 31 provides the relationship of the copy rate and cleaning rate values to the attempted number of grains to be split per second. A grain is the unit of data represented by a single bit.

Table 31. Relationship between the rate, data rate and grains per second values

| User-specified <i>rate</i> attribute value | Data copied/sec | 256 KB grains/sec | 64 KB grains/sec |
|--------------------------------------------|-----------------|-------------------|------------------|
| 1 - 10                                     | 128 KB          | 0.5               | 2                |
| 11 - 20                                    | 256 KB          | 1                 | 4                |
| 21 - 30                                    | 512 KB          | 2                 | 8                |
| 31 - 40                                    | 1 MB            | 4                 | 16               |
| 41 - 50                                    | 2 MB            | 8                 | 32               |
| 51 - 60                                    | 4 MB            | 16                | 64               |
| 61 - 70                                    | 8 MB            | 32                | 128              |
| 71 - 80                                    | 16 MB           | 64                | 256              |
| 81 - 90                                    | 32 MB           | 128               | 512              |
| 91 - 100                                   | 64 MB           | 256               | 1024             |

### An invocation example

```
mkfcmap -source 0 -target 2 -name mapone
```

### The resulting output

```
FlashCopy Mapping, id [1], successfully created
```

---

## prestartfcconsistgrp

The **prestartfcconsistgrp** command prepares a consistency group (a group of FlashCopy mappings) so that the consistency group can be started. This command flushes the cache of any data that is destined for the source volume and forces the cache into the write-through mode until the consistency group is started.

### Syntax

```
▶▶ prestartfcconsistgrp — [-restore] [fc_consist_group_id | fc_consist_group_name] ▶▶
```

### Parameters

#### -restore

(Optional) Specifies the restore flag. This forces the consistency group to be prepared even if the target volume of one of the mappings in the consistency group is being used as a source volume of another active mapping. An active mapping is in the copying, suspended, or stopping state.

*fc\_consist\_group\_id* | *fc\_consist\_group\_name*

(Required) Specifies the name or ID of the consistency group that you want to prepare.

### Description

This command prepares a consistency group (a group of FlashCopy mappings) to subsequently start. The preparation step ensures that any data that resides in the cache for the source volume is first flushed to disk. This step ensures that the FlashCopy target volume is identical to what has been acknowledged to the host operating system as having been written successfully to the source volume.

You can use the **restore** parameter to force the consistency group to be prepared even if the target volume of one or more mappings in the consistency group is being used as a source volume of another active mapping. In this case the mapping restores as shown in the **lsfcmap** view. If the **restore** parameter is specified when preparing a consistency group where none of the target volumes are the source volume of another active mapping, then the parameter is ignored.

You must issue the **prestartfcconsistgrp** command to prepare the FlashCopy consistency group before the copy process can be started. When you have assigned several mappings to a FlashCopy consistency group, you must issue a single prepare command for the whole group to prepare all of the mappings at once.

The consistency group must be in the `idle_or_copied` or `stopped` state before it can be prepared. When you enter the **prestartfcconsistgrp** command, the group enters the preparing state. After the preparation is complete, the consistency group status changes to `prepared`. At this point, you can start the group.

If FlashCopy mappings are assigned to a consistency group, the preparing and the subsequent starting of the mappings in the group must be performed on the consistency group rather than on an individual FlashCopy mapping that is assigned to the group. Only stand-alone mappings, which are mappings that are not assigned to a consistency group, can be prepared and started on their own. A FlashCopy consistency group must be prepared before it can be started.

| This command is rejected if the target of a FlashCopy mapping in the consistency group is in a Metro Mirror or Global Mirror relationship, except where the relationship is one of the following types and is the secondary target of the remote copy:

- | • `idling`
- | • `disconnected`
- | • `consistent_stopped`
- | • `inconsistent_stopped`

| The FlashCopy(r) mapping also fails in the following cases:

- | • You use the **prep** parameter.
- | • The target volume is an active remote copy primary or secondary volume.
- | • The FlashCopy target (and remote copy primary target) volume is offline. If this occurs, the FlashCopy mapping stops and the target volume remains offline.

### An invocation example

```
prestartfcconsistgrp 1
```

### The resulting output

```
No feedback
```

---

## prestartfcmap

The **prestartfcmap** command prepares a FlashCopy mapping so that it can be started. This command flushes the cache of any data that is destined for the source volume and forces the cache into the write-through mode until the mapping is started.

### Syntax

```
➤➤ prestartfcmap — [-restore] [fc_map_id] [fc_map_name] ➤➤
```

## Parameters

### **-restore**

(Optional) Specifies the restore flag. This forces the mapping to be prepared even if the target volume is being used as a source volume in another active mapping. An active mapping is in the copying, suspended, or stopping state.

*fc\_map\_id* | *fc\_map\_name*

(Required) Specifies the name or ID of the mapping to prepare.

## Description

This command prepares a single mapping for subsequent starting. The preparation step ensures that any data that resides in the cache for the source volume is first transferred to disk. This step ensures that the copy that is made is consistent with what the operating system expects on the disk.

The **restore** parameter can be used to force the mapping to be prepared even if the target volume is being used as a source volume of another active mapping. In this case, the mapping is restoring as shown in the **lsfcmap** view. If the **restore** parameter is specified when preparing a mapping where the target volume is not the source volume of another active mapping, then the parameter is ignored.

**Note:** To prepare a FlashCopy mapping that is part of a consistency group, you must use the **prestartfcconsistgrp** command.

The mapping must be in the `idle_or_copied` or `stopped` state before it can be prepared. When the **prestartfcmap** command is processed, the mapping enters the preparing state. After the preparation is complete, it changes to the prepared state. At this point, the mapping is ready to start.

**Attention:** This command can take a considerable amount of time to complete.

| This command is rejected if the target of the FlashCopy mappings is the secondary volume in a Metro  
| Mirror or Global Mirror relationship (so that the FlashCopy target is the remote copy secondary).

| **Note:** If the remote copy is idling or disconnected, even if the FlashCopy and remote copy are pointing  
| to the same volume, the auxiliary volume is not necessarily the secondary volume. In this case, you can  
| start a FlashCopy mapping.

| The FlashCopy mapping also fails in the following cases:

- | • The remote copy is active.
- | • The FlashCopy target (and remote copy primary target) volume is offline. If this occurs, the FlashCopy  
| mapping stops and the target volume remains offline.

### An invocation example

```
prestartfcmap 1
```

### The resulting output

No feedback

---

## rmfconsistgrp

The **rmfconsistgrp** command deletes a FlashCopy consistency group.

## Syntax

```
➤ rmfconsistgrp - [-force] [fc_consist_group_id | fc_consist_group_name] ➤
```

## Parameters

### **-force**

(Optional) Specifies that all of the mappings that are associated with a consistency group that you want to delete are removed from the group and changed to stand-alone mappings. This parameter is only required if the consistency group that you want to delete contains mappings.

*fc\_consist\_group\_id* | *fc\_consist\_group\_name*

(Required) Specifies the ID or name of the consistency group that you want to delete.

## Description

This command deletes the specified FlashCopy consistency group. If there are mappings that are members of the consistency group, the command fails unless you specify the **-force** parameter. When you specify the **-force** parameter, all of the mappings that are associated with the consistency group are removed from the group and changed to stand-alone mappings.

To delete a single mapping in the consistency group, you must use the **rmfcmap** command.

### An invocation example

```
rmfcconsistgrp fcconsistgrp1
```

### The resulting output

No feedback

---

## rmfcmap

The **rmfcmap** command deletes an existing mapping.

## Syntax

```
▶▶ rmfcmap — [-force] [fc_map_id | fc_map_name] ▶▶
```

## Parameters

### **-force**

(Optional) Specifies that the target volume is brought online. This parameter is required if the FlashCopy mapping is in the stopped state.

*fc\_map\_id* | *fc\_map\_name*

(Required) Specifies the ID or name of the FlashCopy mapping to delete. Enter the ID or name last on the command line.

## Description

The **rmfcmap** command deletes the specified mapping if the mapping is in the `idle_or_copied` or `stopped` state. If it is in the `stopped` state, the **-force** parameter is required. If the mapping is in any other state, you must stop the mapping before you can delete it.

Deleting a mapping only deletes the logical relationship between the two virtual disks; it does not affect the virtual disks themselves. However, if you force the deletion, the target virtual disk (which might contain inconsistent data) is brought back online.

| If the target of the FlashCopy mapping is a member of the remote copy, the remote copy can be affected in the following ways:

- If a stopped FlashCopy mapping is deleted and the I/O group associated with the FlashCopy mapping is suspended while this delete is being processed, then all remote copy relationships associated with the target volume of a the FlashCopy mapping that were active while the FlashCopy mapping was copying can be corrupted. You must resynchronize them next time you start the system.
- If a stopped FlashCopy mapping that has previously failed to prepare is deleted, then all remote copy relationships in the set of remote copy relationships associated with the target volume can be corrupted. You must resynchronize them next time you start the system.

### An invocation example

```
rmfcmap testmap
```

### The resulting output

No feedback

## startfcconsistgrp

The **startfcconsistgrp** command starts a FlashCopy consistency group of mappings. This command makes a point-in-time copy of the source volumes at the moment that the command is started.

### Syntax

```

▶▶ startfcconsistgrp -- [-prep] [-restore] [fc_consist_group_id | fc_consist_group_name]

```

### Parameters

#### -prep

(Optional) Specifies that the designated FlashCopy consistency group be prepared prior to starting the FlashCopy consistency group. A FlashCopy consistency group must be prepared before it can be started. When you use this parameter, the system automatically issues the **prestartfcconsistgrp** command for the group that you specify.

#### -restore

(Optional) Specifies the restore flag. When combined with the **prep** option, this forces the consistency group to be prepared even if the target volume of one of the mappings in the consistency group is being used as a source volume in another active mapping. An active mapping is in the copying, suspended, or stopping state.

*fc\_consist\_group\_id* | *fc\_consist\_group\_name*

(Required) Specifies the ID or name of the consistency group mapping to start.

### Description

This command starts a consistency group, which results in a point-in-time copy of the source volumes of all mappings in the consistency group. You can combine the **restore** parameter with the **prep** parameter to force the consistency group to be prepared prior to starting, even if the target volume of one or more mappings in the consistency group is being used as a source volume of another active mapping. In this case, the mapping is restoring as shown in the **lsfcmap** view. If the **restore** parameter is specified when starting a consistency group where none of the target volumes are the source volume of another active mapping, the parameter is ignored.

If a consistency group is started and the target volume of the mapping being started has up to four other incremental FlashCopy mappings using the target, the incremental recording is left on. If there are more than four other incremental FlashCopy mappings using the target volume, the incremental recording for all of these mappings is turned off until they are restarted.

**Note:** The **startfcconsistgrp** command can take some time to process particularly if you have specified the **prep** parameter. If you use the **prep** parameter, you give additional processing control to the system because the system must prepare the mapping before the mapping is started. If the prepare process takes too long, the system completes the prepare but does not start the consistency group. In this case, error message CMMVC6209E displays. To control the processing times of the **prestartfcconsistgrp** and **startfcconsistgrp** commands independently of each other, do not use the **prep** parameter. Instead, first issue the **prestartfcconsistgrp** command, and then issue the **startfcconsistgrp** command to start the copy.

| This command is rejected if the target of the FlashCopy mapping in the specified consistency group is the  
| secondary volume in a Metro Mirror or Global Mirror relationship (so that the FlashCopy target is the  
| remote copy secondary).

| **Note:** If the remote copy is idling or disconnected, even if the FlashCopy and remote copy are pointing  
| to the same volume, the auxiliary volume is not necessarily the secondary volume. In this case, you can  
| start a FlashCopy mapping.

| The FlashCopy mapping also fails in the following cases, if the target of the FlashCopy mapping in the  
| specified consistency group is the primary volume in a Metro Mirror or Global Mirror relationship (so  
| that the FlashCopy target is the remote copy primary):

- The remote copy is active.
- The FlashCopy target (and remote copy primary target) volume is offline. If this occurs, the FlashCopy mapping stops and the target volume remains offline.

### An invocation example

```
startfcconsistgrp -prep 2
```

### The resulting output

No feedback

---

## startfcmap

The **startfcmap** command starts a FlashCopy mapping. This command makes a point-in-time copy of the source volume at the moment that the command is started.

### Syntax

```
▶▶ startfcmap [-prep] [-restore] [fc_map_id] [fc_map_name] ▶▶
```

### Parameters

#### -prep

(Optional) Specifies that the designated mapping be prepared prior to starting the mapping. A mapping must be prepared before it can be started. When you use this parameter, the system automatically issues the **prestartfcmap** command for the group that you specify.

| **Note:** If you have already used the **prestartfcmap** command, you cannot use the **-prep** parameter on  
| the **startfcmap** command; the command fails. However, if the FlashCopy has successfully prepared  
| before, the **startfcmap** command succeeds.

#### -restore

(Optional) Specifies the restore flag. When combined with the **prep** option, this forces the mapping to be prepared even if the target volume is being used as a source volume in another active mapping. An active mapping is in the copying, suspended, or stopping state.

*fc\_map\_id* | *fc\_map\_name*

Specifies the ID or name of the mapping to start.

## Description

This command starts a single mapping, which results in a point-in-time copy of the source volume. You can combine the **restore** parameter with the **prep** parameter to force the mapping to be prepared prior to starting, even if the target volume is being used as a source volume of another active mapping. In this case, the mapping is restoring as shown in the **lsfcmap** view. If the **restore** parameter is specified when starting a mapping where the target volume is not the source volume of another active mapping, the parameter is ignored and the mapping is not restoring as shown in the **lsfcmap** view.

If a mapping is started and the target volume of the mapping being started has up to four other incremental FlashCopy mappings using the target, the incremental recording is left on. If there are more than four other incremental FlashCopy mappings using the target volume, the incremental recording for all of these mappings is turned off until they are restarted.

**Note:** The **startfcmap** command can take some time to start, particularly if you use the **prep** parameter. If you use the **prep** parameter, you give additional starting control to the system. The system must prepare the mapping before the mapping is started. To keep control when the mapping starts, you must issue the **prestartfcmap** command before you issue the **startfcmap** command.

| This command is rejected if the target of the FlashCopy mapping is the secondary volume in a Metro Mirror or Global Mirror relationship (so that the FlashCopy target is the remote copy secondary).

| **Note:** If the remote copy is idling or disconnected, even if the FlashCopy and remote copy are pointing to the same volume, the auxiliary volume is not necessarily the secondary volume. In this case, you can start a FlashCopy mapping.

| The FlashCopy mapping also fails in the following cases, if the target of the FlashCopy mapping is the primary volume in a Metro Mirror or Global Mirror relationship (so that the FlashCopy target is the remote copy primary):

- The remote copy is active.
- The FlashCopy target (and remote copy primary target) volume is offline. If this occurs, the FlashCopy mapping stops and the target volume remains offline.

## An invocation example

```
startfcmap -prep 2
```

## The resulting output

No feedback

---

## stopfcconsistgrp

The **stopfcconsistgrp** command stops all processing that is associated with a FlashCopy consistency group that is in one of the following processing states: prepared, copying, stopping, or suspended.

## Syntax

```
➤ stopfcconsistgrp [-force] [-split] fc_consist_group_id | fc_consist_group_name ➤
```



## Parameters

### **-force**

(Optional) Specifies that all processing that is associated with the mappings of the designated consistency group be stopped immediately.

**Note:** When you use this parameter, all FlashCopy mappings that depend on the mappings in this group (as listed by the **lsfcmapdependentmaps** command) are also stopped.

- If the **-force** parameter is not specified, the command is rejected if the target volume of the FlashCopy consistency group is the primary in a relationship that is mirroring I/O:
- | • consistent\_synchronized
  - | • consistent\_copying
  - | • inconsistent\_copying

If the **-force** parameter is specified, any Metro Mirror or Global Mirror relationships associated with the target volumes of the FlashCopy mappings in the specified consistency group stops. If a remote copy relationship associated with the target was mirroring I/O when the map was copying, it might lose its difference recording capability and require a full resynchronization upon a subsequent restart.

### **-split**

(Optional) Breaks the dependency on the source volumes of any mappings that are also dependent on the target volume. This parameter can only be specified when stopping a consistency group where all maps in the group have progress of 100 as shown by the **lsfcmap** command.

*fc\_consist\_group\_id* | *fc\_consist\_group\_name*

(Required) Specifies the name or ID of the consistency group that you want to stop.

## Description

This command stops a group of mappings in a consistency group. If the copy process is stopped, the target disks become unusable unless they already contain complete images of the source. Disks that contain complete images of the source have a progress of 100, as indicated in the **lsfcmap** command output. The target volume is reported as offline if it does not contain a complete image. Before you can access this volume, the group of mappings must be prepared and restarted.

If the consistency group is in the *idle\_or\_copied* state, the **stopfcconsistgrp** command has no effect and the consistency group stays in the *idle\_or\_copied* state.

**Note:** Prior to SVC 4.2.0, the **stopfcconsistgrp** command always caused the consistency group to go to the stopped state, taking the target volumes offline.

The **split** option can be used when all of the maps in the group have progress of 100. It removes the dependency of any other maps on the source volumes. It might be used prior to starting another FlashCopy consistency group whose target disks are the source disks of the mappings being stopped. Once the consistency group has been stopped with the **split** option, the other consistency group could then be started without the **restore** option.

### An invocation example

```
stopfcconsistgrp testmapone
```

### The resulting output

No feedback

---

## stopfcmap

The **stopfcmap** command stops all processing that is associated with a FlashCopy mapping that is in one of the following processing states: prepared, copying, stopping, or suspended.

### Syntax

```
▶▶ stopfcmap [-force | -split] [fc_map_id | fc_map_name] ▶▶▶
```

### Parameters

#### -force

(Optional) Specifies that all processing that is associated with the designated mapping be stopped immediately.

**Note:** When you use this parameter, all FlashCopy mappings that depend on this mapping (as listed by the **lsfcmapdependentmaps** command) are also stopped.

If the **-force** parameter is not specified, the command is rejected if the target volume of the FlashCopy mapping is the primary in a relationship which is mirroring I/O:

- consistent\_synchronized
- consistent\_copying
- inconsistent\_copying

If the **-force** parameter is specified to a FlashCopy mapping whose target volume is also in a Metro Mirror or Global Mirror relationship, the relationship stops. If a remote copy relationship associated with the target was mirroring I/O when the map was copying, it might lose its difference recording capability and require a full resynchronization on a subsequent restart.

#### -split

(Optional) Breaks the dependency on the source volume of any mappings that are also dependent on the target disk. This parameter can only be specified when stopping a map that has progress of 100 as shown by the **lsfcmap** command.

*fc\_map\_id* | *fc\_map\_name*

(Required) Specifies the name or ID of the mapping to stop.

### Description

This command stops a single mapping. If the copy process is stopped, the target disk becomes unusable unless it already contained a complete image of the source (that is, unless the map had a progress of 100 as shown by the **lsfcmap** command). Before you can use the target disk, the mapping must once again be prepared and then reprocessed (unless the target disk already contained a complete image).

Only stand-alone mappings can be stopped using the **stopfcmap** command. Mappings that belong to a consistency group must be stopped using the **stopfcconsistgrp** command.

If the mapping is in the `idle_or_copied` state, the **stopfcmap** command has no effect and the mapping stays in the `idle_or_copied` state.

**Note:** Before SAN Volume Controller 4.2.0, the **stopfcmap** command always changed the mapping state to stopped and took the target volume offline. This change can break scripts that depend on the previous behavior.

The **split** option can be used when the mapping has progress of 100. It removes the dependency of any other mappings on the source volume. It might be used prior to starting another FlashCopy mapping whose target disk is the source disk of the mapping being stopped. Once the mapping has been stopped with the **split** option, the other mapping could then be started without the **restore** option.

#### **An invocation example**

```
stopfcmap testmapone
```

#### **The resulting output**

No feedback



---

## Chapter 16. Host commands

The following commands enable you to work with host objects with the SAN Volume Controller.

---

### addhostiogrp

The **addhostiogrp** command enables you to map I/O groups to an existing host object.

#### Syntax

```
➤➤ addhostiogrp — [-iogrp — iogrp_list] [host_name]
 [-iogrpall] [host_id]
```

#### Parameters

**-iogrp** *iogrp\_list*

(Required if you do not use **-iogrpall**) Specifies a colon-separated list of one or more I/O groups that must be mapped to the host. You cannot use this parameter with the **-iogrpall** parameter.

**-iogrpall**

(Required if you do not use **-iogrp**) Specifies that all the I/O groups must be mapped to the specified host. You cannot use this parameter with the **-iogrp** parameter.

*host\_id* | *host\_name*

(Required) Specifies the host to which the I/O groups must be mapped, either by ID or by name.

#### Description

This command allows you to map the list of I/O groups to the specified host object.

#### An invocation example

```
addhostiogrp -iogrpall testhost
```

#### The resulting output

No feedback

---

### addhostport

The **addhostport** command adds worldwide port names (WWPNs) or iSCSI names to an existing host object.

#### Syntax

```
➤➤ addhostport — [-hbawwpn — wwpn_list] [host_name]
 [-iscsiname—iscsi_name_list] [-force] [host_id]
```

#### Parameters

**-hbawwpn** *wwpn\_list*

(Required if you do not use **iscsiname**) Specifies the list of Fibre Channel host ports to add to the host. At least one WWPN or iSCSI name must be specified. You cannot use this parameter with the **iscsiname** parameter.

**-iscsiname** *iscsi\_name\_list*

(Required if you do not use **hbawwpn**) Specifies the comma-separated list of iSCSI names to add to the host. At least one WWPN or iSCSI name must be specified. You cannot use this parameter with the **hbawwpn** parameter.

**-force**

(Optional) Specifies that the list of ports be added to the host without the validation of any WWPNS or iSCSI names.

*host\_id* | *host\_name*

(Required) Specifies the host object to add ports to, either by ID or by name.

## Description

This command adds a list of HBA WWPNS or iSCSI names to the specified host object. Any virtual disks that are mapped to this host object automatically map to the new ports.

Only WWPNS that are logged-in unconfigured can be added. For a list of candidate WWPNS, use the **lshbaportcandidate** command.

Some HBA device drivers do not log in to the fabric until they can recognize target LUNs. Because they do not log in, their WWPNS are not recognized as candidate ports. You can specify the **force** parameter with the **addhostport** command to stop the validation of the WWPN list.

**Note:** When all I/O groups are removed from an iSCSI host, you cannot add a port to the iSCSI host until you have mapped the iSCSI host to at least one I/O group. After mapping the iSCSI host to at least one I/O group, resubmit the **addhostport** command. After adding the port to the host, you must create a host authentication entry using the **chhost** command.

### An invocation example

```
addhostport -hbawwpn 210100E08B251DD4 host_one
```

### The resulting output

No feedback

### An invocation example

```
addhostport -iscsiname iqn.localhost.hostid.7f000001 mhost13
```

### The resulting output

No feedback

---

## chhost

The **chhost** command changes the name or type of a host object. This does not affect any existing virtual disk-to-host mappings.

## Syntax

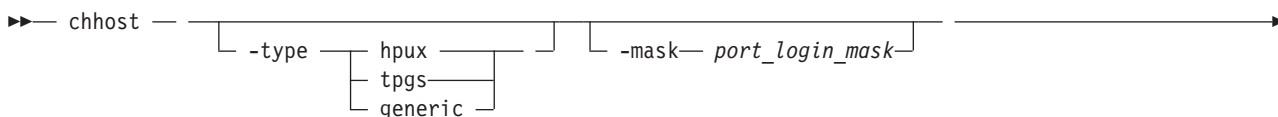

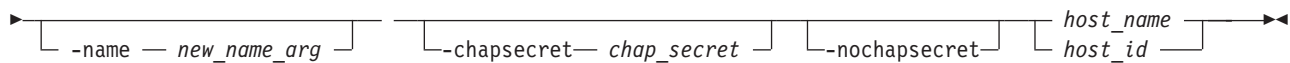

## Parameters

### **-type** *hpux* | *tpgs* | *generic*

(Optional) Specifies the type of host: **hpux**, **tpgs**, or **generic**. The default is **generic**. The **tpgs** parameter enables extra target port unit attentions. Refer to SAN Volume Controller host attachment documentation for more information on the hosts that require the **type** parameter.

### **-name** *new\_name\_arg*

(Optional) Specifies the new name that you want to assign to the host object.

### **-mask** *port\_login\_mask*

(Optional) Specifies which node target ports that a host can access. The port mask is four binary bits and is made of a combination of 0's and 1's, where 0 indicates that the corresponding target port cannot be used and 1 indicates that it can be used. The right-most bit in the mask corresponds to the lowest numbered target port (1 not 4) on a node. Valid mask values range from **0000** (no ports enabled) to **1111** (all ports enabled). For example, a mask of **0011** enables port 1 and port 2. The default value is **1111** (all ports enabled).

### **-chapsecret** *chap\_secret*

(Optional) Sets the Challenge Handshake Authentication Protocol (CHAP) secret used to authenticate the host for iSCSI I/O. This secret is shared between the host and the cluster. The CHAP secret for each host can be listed using the **lsiscsiauth** command.

### **-nochapsecret**

(Optional) Clears any previously set CHAP secret for this host.

### *host\_name* | *host\_id*

(Required) Specifies the host object to modify, either by ID or by current name.

## Description

This command can change the name of the specified host to a new name, or it can change the type of host. This command does not affect any of the current virtual disk-to-host mappings.

The port mask applies to logins from the host initiator port that are associated with the host object. For each login between a host HBA port and node port, the node examines the port mask that is associated with the host object for which the host HBA is a member and determines if access is allowed or denied. If access is denied, the node responds to SCSI commands as if the HBA port is unknown.

**Note:** When all I/O groups are removed from an iSCSI host, the **lsiscsiauth** command does not display the authentication entry for that host. Use the **addhostiogrp** command to map the iSCSI host to at least one I/O group, and then use the **addhostport** command to add the iSCSI port into it. You must also add authentication for that host using the **chhost** command with either the **chapsecret** or **nochapsecret** parameter.

### An invocation example

```
chhost -name testhostlode -mask 0011 hostone
```

### The resulting output

No feedback

---

## mkhost

The **mkhost** command creates a logical host object.

## Syntax

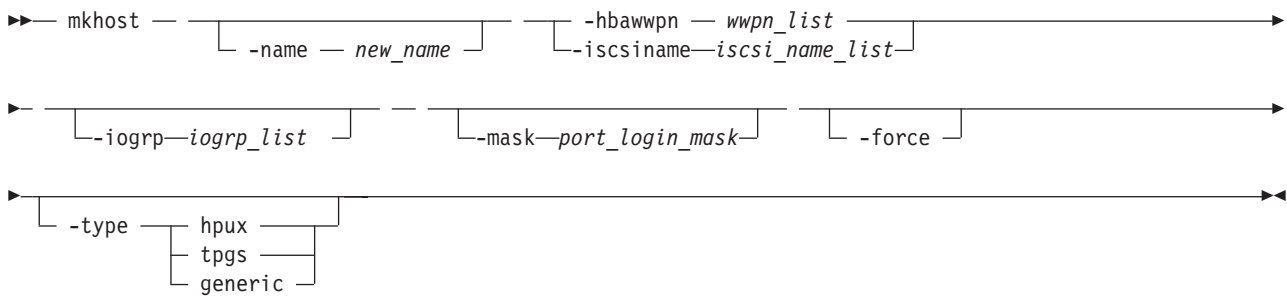

## Parameters

### **-name** *new\_name*

(Optional) Specifies a name or label for the new host object.

### **-hbawwn** *wwpn\_list*

(Required if you do not use **iscsiname**) Specifies one or more host bus adapter (HBA) worldwide port names (WWPNs) to add to the specified host object. At least one WWPN or iSCSI name must be specified. You cannot use this parameter with the **iscsiname** parameter.

### **-iscsiname** *iscsi\_name\_list*

(Required if you do not use **hbawwn**) Specifies the comma-separated list of iSCSI names to add to the host. At least one WWPN or iSCSI name must be specified. You cannot use this parameter with the **hbawwn** parameter.

### **-iogrp** *iogrp\_list*

(Optional) Specifies a set of one or more I/O groups that the host can access the VDisks from. I/O groups are specified using their names or IDs, separated by a colon. Names and IDs can be mixed in the list. If this parameter is not specified, the host is associated with all I/O groups.

### **-mask** *port\_login\_mask*

(Optional) Specifies which node target ports that a host can access. The port mask is four binary bits and is made up of a combination of 0's and 1's, where 0 indicates that the corresponding target port cannot be used and 1 indicates that it can be used.. The right-most bit in the mask corresponds to the lowest numbered target port (1 not 4) on a node. Valid mask values range from **0000** (no ports enabled) to **1111** (all ports enabled). For example, a mask of **0011** enables port 1 and port 2. The default value is **1111** (all ports enabled).

### **-force**

(Optional) Specifies that a logical host object be created without validation of the WWPNs.

### **-type** **hpux** | **tpgs** | **generic**

(Optional) Specifies the type of host: **hpux**, **tpgs**, or **generic**. The default is **generic**. The **tpgs** parameter enables extra target port unit attentions. Refer to SAN Volume Controller host attachment documentation for more information on the hosts that require the **type** parameter.

## Description

The **mkhost** command associates one or more HBA WWPNs or iSCSI names with a logical host object. This command creates a new host. The ID is displayed when the command completes. You can subsequently use this object when you map virtual disks to hosts by using the **mkvdiskhostmap** command.

Issue the **mkhost** command only once. The cluster scans the fabric for WWPNs in the host zone. The cluster itself cannot filter into the hosts to determine which WWPNs are in which hosts. Therefore, you must use the **mkhost** command to identify the hosts.



After you identify the hosts, mappings are created between hosts and virtual disks. These mappings effectively present the virtual disks to the hosts to which they are mapped. All WWPNs in the host object are mapped to the virtual disks.

Some HBA device drivers do not log in to the fabric until they can see target logical unit numbers (LUNs). Because they do not log in, their WWPNs are not recognized as candidate ports. You can specify the **force** parameter with this command to stop the validation of the WWPN list.

This command fails if you add the host to an I/O group that is associated with more host ports or host objects than is allowed by the limits within the cluster.

For additional information, see the **mkvdiskhostmap** and **lshbaportcandidate** commands.

### An invocation example

```
mkhost -name hostone -hbawwpn 210100E08B251DD4 -force -mask 1001
```

### The resulting output

```
Host id [1] successfully created
```

### An invocation example

```
mkhost -iscsiname iqn.localhost.hostid.7f000001 -name newhost
```

### The resulting output

```
Host, id [10], successfully created
```

---

## rmhost

The **rmhost** command deletes a host object.

### Syntax

```
➔ rmhost -- [-force] [host_name | host_id] ➔
```

### Parameters

#### -force

(Optional) Specifies that you want the system to delete the host object even if mappings still exist between this host and virtual disks (VDisks). When the **-force** parameter is specified, the mappings are deleted before the host object is deleted.

*host\_name* | *host\_id*

(Required) Specifies the host object to delete, either by ID or by name.

### Description

The **rmhost** command deletes the logical host object. The WWPNs that were contained by this host object (if it is still connected and logged in to the fabric) are returned to the unconfigured state. When you issue the **lshbaportcandidate** command, the host objects are listed as candidate ports.

If any mappings still exist between this host and virtual disks, the command fails unless you specify the **-force** parameter. When the **-force** parameter is specified, the **rmhost** command deletes the mappings before the host object is deleted.

### An invocation example

rmhost host\_one

### The resulting output

No feedback

---

## rmhostiogr

The **rmhostiogr** command enables you to delete mappings between one or more I/O groups and a specified host object.

### Syntax

```
rmhostiogr -iogr iogr_list [-iograll] [-force] [host_name | host_id]
```

### Parameters

#### **-iogr** *iogr\_list*

(Required) Specifies a set of one or more I/O group mappings that will be deleted from the host. You cannot use this parameter with the **-iograll** parameter.

#### **-iograll**

(Optional) Specifies that all the I/O group mappings that are associated with the specified host must be deleted from the host. You cannot use this parameter with the **-iogr** parameter.

#### **-force**

(Optional) Specifies that you want the system to remove the specified I/O group mappings on the host even if the removal of a host to I/O group mapping results in the loss of VDisk-to-host mappings.

*host\_id* | *host\_name*

(Required) Specifies the identity of the host either by ID or name from which the I/O group mappings must be deleted.

### Description

The **rmhostiogr** command deletes the mappings between the list of I/O groups and the specified host object.

This command fails if any of the I/O groups that are deleted from the host contain VDIsks that have host mappings to the host. To resolve this problem, do one of the following:

- Delete the VDIsks-to-host mappings that are causing the error.
- Delete the VDIsks or the host.
- Issue the **rmhostiogr** command with the **-force** parameter.

**Note:** When all I/O groups are removed from an iSCSI host, and you want to add an iSCSI port to the host, refer to the **addhostport** and **chhost** commands.

### An invocation example

```
rmhostiogr -iogr 1:2 host0
```

### The resulting output

No feedback

---

## rmhostport

The **rmhostport** command deletes worldwide port names (WWPNs) or iSCSI names from an existing host object.

### Syntax

```
►►— rmhostport — [-hbawwpn wwpn_list] [-iscsiname iscsi_name_list] [-force] [host_name | host_id] ►►
```

### Parameters

#### **-hbawwpn** *wwpn\_list*

(Required if you do not use **iscsiname**) Specifies the list of Fibre Channel host ports to delete from the host. At least one WWPN or iSCSI name must be specified. You cannot use this parameter with the **iscsiname** parameter.

#### **-iscsiname** *iscsi\_name\_list*

(Required if you do not use **hbawwpn**) Specifies the comma-separated list of iSCSI names to delete from the host. At least one WWPN or iSCSI name must be specified. You cannot use this parameter with the **hbawwpn** parameter.

#### **-force**

(Optional) Forces the deletion of the specified ports. This overrides the check that all of the WWPNs or iSCSI names in the list are mapped to the host specified.

*host\_name* | *host\_id*

(Required) Specifies the host name or the host ID.

### Description

This command deletes the list of HBA WWPNs or iSCSI names from the specified host object. If the WWPN ports are still logged in to the fabric, they become unconfigured and are listed as candidate WWPNs. See also the **lshbaportcandidate** command.

Any virtual disks that are mapped to this host object are automatically unmapped from the ports.

**Replacing an HBA in a host:** List the candidate HBA ports by issuing the **lshbaportcandidate** command. A list of the HBA ports that are available to be added to host objects is displayed. One or more of these ports corresponds with one or more WWPNs that belong to the new HBA. Locate the host object that corresponds to the host in which you have replaced the HBA. The following command lists all the defined host objects:

```
lshost
```

To list the WWPNs that are currently assigned to the host, issue the following:

```
lshost hostobjectname
```

where *hostobjectname* is the name of the host object.

Add the new ports to the existing host object by issuing the following command:

```
addhostport -hbawwpn one or more existing WWPNs
separated by : hostobjectname/ID
```

where *one or more existing WWPNS separated by :* and *hostobjectname/id* correspond to those values listed in the previous steps.

Remove the old ports from the host object by issuing the following command:

```
rmhostport -hbawpn one or more existing WWPNS
separated by : hostobjectname/ID
```

where *one or more existing WWPNS separated by :* corresponds with those WWPNS that are listed in the previous step that belong to the old HBA that has been replaced. Any mappings that exist between the host object and VDisks are automatically applied to the new WWPNS. Therefore, the host recognizes that the VDisks are the same SCSI LUNs as before. See the *Multipath Subsystem Device Driver: User's Guide* for additional information about dynamic reconfiguration.

#### **An invocation example**

```
rmhostport -hbawpn 210100E08B251DD4 host_one
```

#### **The resulting output**

No feedback

#### **An invocation example**

```
rmhostport -iscsiname iqn.localhost.hostid.7f000001 mchost13
```

#### **The resulting output**

No feedback

---

## Chapter 17. Information commands

The following commands enable you display specific types of SAN Volume Controller information.

**Note:** IDs are assigned at run-time by the system and cannot be relied upon to be the same after configuration restoration. Therefore, use object names instead of IDs whenever possible.

---

### ls2145dumps (Deprecated)

**Attention:** The `svcinfo ls2145dumps` command is deprecated. Use the `svcinfo lsdumps` command to display a list of files in a particular dumps directory.

---

### lscimomdumps (Deprecated)

**Attention:** The `svcinfo lscimomdumps` command is deprecated. Use the `svcinfo lsdumps` command to display a list of files in a particular dumps directory.

---

### lscopystatus

Use the `lscopystatus` command to determine whether any file copies are currently in progress.

#### Syntax

```
▶▶ lscopystatus [-nohdr] [-delim delimiter] ▶▶
```

#### Parameters

##### **-nohdr**

(Optional) By default, headings are displayed for each column of data in a concise style view, and for each item of data in a detailed style view. The **-nohdr** parameter suppresses the display of these headings.

**Note:** If there is no data to be displayed, headings are not displayed.

##### **-delim *delimiter***

(Optional) By default in a concise view, all columns of data are space-separated. The width of each column is set to the maximum possible width of each item of data. In a detailed view, each item of data has its own row, and if the headers are displayed, the data is separated from the header by a space. The **-delim** parameter overrides this behavior. Valid input for the **-delim** parameter is a one-byte character. If you enter `-delim :` on the command line, the colon character (:) separates all items of data in a concise view; for example, the spacing of columns does not occur. In a detailed view, the data is separated from its header by the specified delimiter.

#### Description

This command displays an indicator that shows if a file copy is currently in progress. Only one file can be copied in the cluster at a time.

#### An invocation example

```
lscopystatus
```

## The resulting output

```
status
active
```

---

## lscluster

The **lscluster** command returns a concise list or a detailed view of a clustered system.

## Syntax

```
lscluster [-filtervalue attribute=value] [-nohdr] [-bytes]
 [-delim delimiter] [-filtervalue?] [cluster_id]
 [cluster_name]
```

## Parameters

### **-filtervalue** *attribute=value*

(Optional) Specifies a list of one or more filters. Only objects with a value that matches the filter attribute value are displayed. If a capacity is specified, the units must also be included.

**Note:** Some filters allow the asterisk character (\*) when you enter the command. The following rules apply to the use of wildcard characters with the SAN Volume Controller CLI:

- The wildcard character is an asterisk (\*).
- The command can contain a maximum of one wildcard.
- When you use a wildcard, you must enclose the filter entry within double quotation marks (""), as follows:

```
lscluster -filtervalue "name=md*"
```

### **-nohdr**

(Optional) By default, headings are displayed for each column of data in a concise style view, and for each item of data in a detailed style view. The **-nohdr** parameter suppresses the display of these headings.

**Note:** If there is no data to be displayed, headings are not displayed.

### **-bytes**

(Optional) Specifies that you want the report to display all capacities as bytes.

### **-delim** *delimiter*

(Optional) By default in a concise view, all columns of data are space-separated. The width of each column is set to the maximum possible width of each item of data. In a detailed view, each item of data has its own row, and if the headers are displayed, the data is separated from the header by a space. The **-delim** parameter overrides this behavior. Valid input for the **-delim** parameter is a one-byte character. If you enter **-delim :** on the command line, the colon character (:) separates all items of data in a concise view; for example, the spacing of columns does not occur. In a detailed view, the data is separated from its header by the specified delimiter.

### **-filtervalue?**

(Optional) displays a list of filters that can be applied against this view. The following filter attributes are valid for the **lscluster** command:

- **cluster\_name**
- **cluster\_unique\_id**
- **id**

- **name**

*cluster\_id* | *cluster\_name*

(Optional) Specifies the name or ID of a cluster. When you use this parameter, the detailed view of the specific clustered system is displayed and any value that you specified by the **-filtervalue** parameter is ignored. If you do not specify the *cluster\_id* | *cluster\_name* parameter, the concise view of all clusters that match the filtering requirements that are specified by the **-filtervalue** parameter are displayed.

## Description

This command displays a concise list or a detailed view of a cluster.

Table 32 provides the attribute values that can be displayed as output view data.

Table 32. Attribute values

| Attribute          | Possible Values                                                                                                                                                                                                                                        |
|--------------------|--------------------------------------------------------------------------------------------------------------------------------------------------------------------------------------------------------------------------------------------------------|
| location           | local, remote                                                                                                                                                                                                                                          |
| statistics status  | on, off                                                                                                                                                                                                                                                |
| email_state        | running, stopped, invalid                                                                                                                                                                                                                              |
| partnership        | fully_configured, partially_configured_local, partially_configured_local_stopped, not_present, fully_configured_stopped, fully_configured_remote_stopped, fully_configured_local_excluded, fully_configured_remote_excluded, fully_configured_exceeded |
| tier               | Which tier information is being reported                                                                                                                                                                                                               |
| tier_capacity      | The total MDisk storage in the tier.                                                                                                                                                                                                                   |
| tier_free_capacity | The amount of MDisk storage in the tier that is unused.                                                                                                                                                                                                |

Information about the remote clustered system is reported by the **lscluster** command if the **mkpartnership** command has been issued from the local clustered system to the remote clustered system; for example, if the partnership has been at least partially established from the local clustered system.

You can issue the **lscluster** command to display a detailed view of the clustered system.

```
lscluster -delim : 10030a007e5
```

where **10030a007e5** is the clustered system name.

Detailed view shows the fields described for remote clusters only; if the clustered system **Location** is **local**, then **Partnership** and **Bandwidth** do not apply (and are not defined or provided). For a remote clustered system, these fields indicate the following information:

- **Location:** remote
- **Partnership:**

### **fully\_configured**

The **mkpartnership** command has been issued in both directions and the remote clustered system is online and available.

### **partially\_configured\_local**

The **mkpartnership** command has only been issued from the local clustered system to the remote clustered system. The remote clustered system is online and available for partnership.

### **partially\_configured\_local\_stopped**

The **mkpartnership** command has only been issued from the local clustered system to the remote clustered system. The **chpartnership** command with the **stop** parameter has been issued from the local cluster, and the remote clustered system is online and available. You need to issue the **chpartnership** command with the **start** parameter on the local clustered system, and **mkpartnership** on the remote clustered system.

### **not\_present**

The **mkpartnership** command has been issued from the local clustered system to the remote clustered system, and the remote clustered system is not available. Either the remote clustered system is offline, or it is not connected to the local cluster.

### **fully\_configured\_stopped**

The **mkpartnership** command has been issued in both directions and the remote clustered system is online and available. The **chpartnership** command with the **stop** parameter has been issued from the local clustered system.

### **fully\_configured\_remote\_stopped**

The **mkpartnership** command has been issued in both directions and the remote clustered system is online and available. The **chpartnership** command with the **stop** parameter has been issued from the remote clustered system.

### **fully\_configured\_local\_excluded**

The **mkpartnership** command has been issued in both directions. The local clustered system has excluded the connection to the remote clustered system due to too many problems, or either clustered system in the partnership is unable to sustain the I/O workload for the Metro Mirror or Global Mirror relationships.

### **fully\_configured\_remote\_excluded**

The **mkpartnership** command has been issued in both directions. The remote clustered system has excluded the connection to the local clustered system due to too many problems, or either clustered system in the partnership is unable to sustain the I/O workload for the Metro Mirror or Global Mirror relationships.

### **fully\_configured\_exceeded**

There are too many clustered systems in the clustered system network, and the partnership from the local clustered system to the remote has been disabled. Refer to the 1710/1720 errors in the clustered system error log at the local and remote clustered system.

- **Bandwidth:** The bandwidth available on the intercluster link for background copy, in megabytes per second (MBps).

## **A concise invocation example**

```
lscluster -delim :
```

## **The concise resulting output**

```
id:name:location:partnership:bandwidth:id_alias
000002006420A162:cluster0:local:::000002006420A162
```

## **An invocation example**

```
lscluster cluster1
```

## **The resulting output**

```
id 0000020061C15D90
name cluster1
location local
partnership
bandwidth
total_mdisk_capacity 8.1TB
space_in_mdisk_grps 8.1TB
```



```

space_allocated_to_vdisks 8.00TB
total_free_space 131.9GB
statistics_status on
statistics_frequency 15
required_memory 0
cluster_locale en_US
time_zone 522 UTC
code_level 6.1.0.0 (build 42.8.1006110000)
FC_port_speed 2Gb
console_IP 9.1.114.20:443
id_alias 0000020061C15D90
gm_link_tolerance 300
gm_inter_cluster_delay_simulation 0
gm_intra_cluster_delay_simulation 0
email_reply
email_contact
email_contact_primary
email_contact_alternate
email_contact_location
email_state stopped
inventory_mail_interval 0
total_vdiskcopy_capacity 8.00TB
total_used_capacity 8.00TB
total_overallocation 98
total_vdisk_capacity 8.00TB
cluster_ntp_IP_address
cluster_isns_IP_address
iscsi_auth_method none
iscsi_chap_secret
auth_service_configured no
auth_service_enabled no
auth_service_url
auth_service_user_name
auth_service_pwd_set no
auth_service_cert_set no
relationship_bandwidth_limit 25
gm_max_host_delay 5
tier_generic_ssd
tier_capacity 0.00MB
tier_free_capacity 0.00MB
tier_generic_hdd
tier_capacity 8.13TB
tier_free_capacity 131.88GB
email_contact2
email_contact2_primary
email_contact2_alternate
total_allocated_extent_capacity 8.00TB

```

### **An invocation example for a clustered system with two tiers**

```
lscluster china6
```

### **The resulting output**

```

id 000002006220A5EE
name china6
location local
partnership fully_configured_stopped
bandwidth
total_mdisk_capacity 474.1GB
space_in_mdisk_grps 474.1GB
space_allocated_to_vdisks 1.87GB
total_free_space 472.2GB
statistics_status on
statistics_frequency 15
required_memory 0
cluster_locale en_US
time_zone 325 Etc/GMT+1

```

```

code_level 6.1.0.0 (build 46.4.1008240000)
FC_port_speed 2Gb
console_IP 9.71.43.210:443
id_alias 000002006220A5EE
gm_link_tolerance 300
gm_inter_cluster_delay_simulation 0
gm_intra_cluster_delay_simulation 0
email_reply:fred@mycompany.com
email_contact:Fred Higgins
email_contact_primary:01202 123456
email_contact_alternate:44-202-876543-4455
email_contact_location:London Thames Bank
email_state:running
inventory_mail_interval:0
total_vdiskcopy_capacity 30.58GB
total_used_capacity 1.28GB
total_overallocation 6
total_vdisk_capacity 20.27GB
cluster_ntp_IP_address
cluster_isns_IP_address
iscsi_auth_method none
iscsi_chap_secret
auth_service_configured:yes
auth_service_enabled:yes
auth_service_url:https://1.2.3.4/login
auth_service_user_name:secadmin
auth_service_pwd_set:yes
auth_service_cert_set:yes
relationship_bandwidth_limit 25
gm_max_host_delay 5
tier generic_ssd
tier_capacity 270.91GB
tier_free_capacity 270.03GB
tier generic_hdd
tier_capacity 203.19GB
tier_free_capacity 201.94GB
email_contact2:barry
email_contact2_primary:6347
email_contact2_alternate:6589
total_allocated_extent_capacity 2.97GB

```

---

## Isclustercandidate

The **Isclustercandidate** command lists the clustered systems (systems) that are available for setting up a partnership with the local system. This is a prerequisite for creating inter-system Metro or Global Mirror relationships.

### Syntax

```

▶▶ Isclustercandidate — [-nohdr] [-delim — delimiter]

```

### Parameters

#### -nohdr

(Optional) By default, headings are displayed for each column of data in a concise style view, and for each item of data in a detailed style view. The **-nohdr** parameter suppresses the display of these headings.

**Note:** If there is no data to be displayed, headings are not displayed.

### **-delim** *delimiter*

(Optional) By default in a concise view, all columns of data are space-separated. The width of each column is set to the maximum possible width of each item of data. In a detailed view, each item of data has its own row, and if the headers are displayed, the data is separated from the header by a space. The **-delim** parameter overrides this behavior. Valid input for the **-delim** parameter is a one-byte character. If you enter **-delim :** on the command line, the colon character (:) separates all items of data in a concise view; for example, the spacing of columns does not occur. In a detailed view, the data is separated from its header by the specified delimiter.

## Description

This command displays a list of systems that are available as candidate partner systems to form a Metro Mirror or Global Mirror partnership between two systems.

Output from the command shows the system ID, name, and configured status of the remote candidate system. The remote candidate system forms a partnership with the local system when you use the **mkpartnership** command. The remote system shows the partnership status as **partially\_configured\_local\_stopped** or **partially\_configured\_local** when you use the **lscluster** command. The **lsclustercandidate** command displays the configured status of those remote systems that have formed a partnership with the local system.

### An invocation example

```
lsclustercandidate
```

### The resulting output

| id               | configured | cluster_name |
|------------------|------------|--------------|
| 0000010034E0F430 | no         | ldcluster26  |

---

## lsclusterip

The **lsclusterip** command returns a list of the clustered system management IP addresses configured for each port.

## Syntax

```
lsclusterip [-nohdr] [-delim delimiter] [-filtervalue attribute=value] [-filtervalue?] [cluster_id] [cluster_name]
```

## Parameters

### **-nohdr**

(Optional) By default, headings are displayed for each column of data in a concise style view, and for each item of data in a detailed style view. The **-nohdr** parameter suppresses the display of these headings.

**Note:** If there is no data to be displayed, headings are not displayed.

### **-delim** *delimiter*

(Optional) By default in a concise view, all columns of data are space-separated. The width of each column is set to the maximum possible width of each item of data. In a detailed view, each item of data has its own row, and if the headers are displayed, the data is separated from the header by a space. The **-delim** parameter overrides this behavior. Valid input for the **-delim** parameter is a one-byte character. If you enter **-delim :** on the command line, the colon character (:) separates all

items of data in a concise view; for example, the spacing of columns does not occur. In a detailed view, the data is separated from its header by the specified delimiter.

**-filtervalue** *attribute=value*

(Optional) Specifies a list of one or more filters. Only objects with a value that matches the filter attribute value are displayed. If a capacity is specified, the units must also be included.

**Note:** Some filters allow the asterisk character (\*) when you enter the command. The following rules apply to the use of wildcard characters with the SAN Volume Controller CLI:

- The wildcard character is an asterisk (\*).
- The command can contain a maximum of one wildcard.
- When you use a wildcard, you must enclose the filter entry within double quotation marks (""), as follows:

```
lsclusterip -filtervalue "cluster_name=md*"
```

**-filtervalue?**

(Optional) displays a list of filters that can be applied against this view. The following filter attributes are valid for the **lsclusterip** command:

- **port\_id**
- **cluster\_name**
- **cluster\_id**

*cluster\_id* | *cluster\_name*

(Required) Specifies the name or ID of a clustered system.

## Description

This command displays a list of the clustered system management IP addresses configured for each port.

### A concise invocation example

```
lsclusterip -delim ,
```

### The concise resulting output

```
cluster_id,cluster_name,location,port_id,IP_address,subnet_mask,
gateway,IP_address_6,gateway_6,prefix_6
000002006CC0B71A,c11,local,1,192.168.1.2,DHCP,255.255.255.0,192.168.1.1,
2001:0db8:85a3:0000:0000:8a2e:0370:7334,2001:0db8:85a3:0000:0000:8a2e:0370:7334,
2001:0db8:85a3:0000:0000:8a2e:0370:7334,64
000002006CC0B71A,c11,local,2,192.168.1.2,DHCP,255.255.255.0,192.168.1.1,
2001:0db8:85a3:0000:0000:8a2e:0370:7334,2001:0db8:85a3:0000:0000:8a2e:0370:7334,
2001:0db8:85a3:0000:0000:8a2e:0370:7334,64
000002006CC0B7110,c12,remote,1,192.168.1.2,DHCP,255.255.255.0,192.168.1.1,
2001:0db8:85a3:0000:0000:8a2e:0370:7334,2001:0db8:85a3:0000:0000:8a2e:0370:7334,
2001:0db8:85a3:0000:0000:8a2e:0370:7334,64
000002006CC0B7110,c12,remote,2,192.168.1.2,DHCP,255.255.255.0,192.168.1.1,
2001:0db8:85a3:0000:0000:8a2e:0370:7334,2001:0db8:85a3:0000:0000:8a2e:0370:7334,
2001:0db8:85a3:0000:0000:8a2e:0370:7334,64
```

### A detailed invocation example

```
lsclusterip 000002006CC0B71A
```

### The detailed resulting output

```
cluster_id 000002006CC0B71A
cluster_name c11
location local
port_id 1
IP_address 192.168.1.2
```

```

subnet_mask 255.255.255.0
gateway 192.168.1.1
IP_address_6 2001:0db8:85a3:0000:0000:8a2e:0370:7334
gateway_6 2001:0db8:85a3:0000:0000:8a2e:0370:7334
prefix_6 64

```

```

cluster_id 000002006CC0B71A
cluster_name c11
location local
port_id 2
IP_address 192.168.1.2
subnet_mask 255.255.255.0
gateway 192.168.1.1
IP_address_6 2001:0db8:85a3:0000:0000:8a2e:0370:7334
gateway_6 2001:0db8:85a3:0000:0000:8a2e:0370:7334
prefix_6 64

```

---

## Iscontroller

The **iscontroller** command returns a concise list, or a detailed view, of controllers that are visible to the cluster.

### Syntax

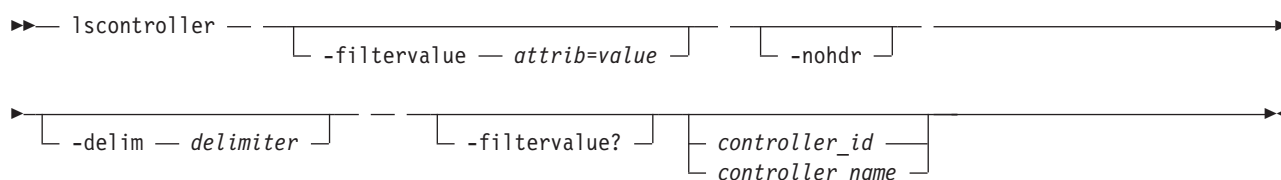

### Parameters

#### **-filtervalue** *attrib=value*

(Optional) Specifies a list of one or more filters. Only objects with a value that matches the filter attribute value are returned. If a capacity is specified, the units must also be included.

**Note:** Some filters allow the use of a wildcard when you enter the command. The following rules apply to the use of wildcards with the SAN Volume Controller CLI:

- The wildcard character is an asterisk (\*).
- The command can contain a maximum of one wildcard, which must be the first or last character in the string.
- When using a wildcard, enclose the filter entry within double quotation marks (""), as follows:

```
iscontroller -filtervalue "name=md*"
```

#### **-nohdr**

(Optional) By default, headings are displayed for each column of data in a concise style view, and for each item of data in a detailed style view. The **-nohdr** parameter suppresses the display of these headings.

**Note:** If there is no data to be displayed, headings are not displayed.

#### **-delim** *delimiter*

(Optional) By default in a concise view, all columns of data are space-separated. The width of each column is set to the maximum possible width of each item of data. In a detailed view, each item of data has its own row, and if the headers are displayed, the data is separated from the header by a space. The **-delim** parameter overrides this behavior. Valid input for the **-delim** parameter is a one-byte character. If you enter **-delim :** on the command line, the colon character (:) separates all

items of data in a concise view; for example, the spacing of columns does not occur. In a detailed view, the data is separated from its header by the specified delimiter.

#### **-filtervalue?**

(Optional) Displays the valid filter attributes. The following filter attributes for the **lscontroller** command are valid:

- controller\_id
- id

*controller\_id | controller\_name*

(Optional) Specifies the name or ID of a controller. When you use this parameter, the detailed view of the specific controller is returned and any value that is specified by the **-filtervalue** parameter is ignored. If you do not specify the *controller\_id | controller\_name* parameter, the concise view displays all controllers matching the filtering requirements that are specified by the **-filtervalue** parameter.

## **Description**

This command returns a concise list, or a detailed view, of controllers visible to the cluster.

The following values are applicable to the data in the output views:

degraded no, yes

To differentiate the name of a storage controller from the name shown on the cluster, list the storage controllers by issuing the **lscontroller** command. Record the controller name or ID for the controller that you want to determine. For the controller in question, issue the **lscontroller controller name | id** command, where *controller name | id* is the controller name or ID. Record the worldwide node name (WWNN) for the controller. You can use the WWNN to determine the actual storage controller by launching the native controller user interface, or by using the command line tools it provides to verify the actual controller that has the WWNN.

#### **Notes:**

1. The *mdisk\_link\_count* value is the number of MDisks currently using this controller as their active controller.
2. The *max\_mdisk\_link\_count* value is the highest value that the *mdisk\_link\_count* has reached since it was last reset to the *mdisk\_link\_count* value. This value is reset by specific maintenance procedures and when the cluster error log is cleared.
3. The controller *path\_count* value is the sum of the MDisk *path\_count* values for MDisks currently using this controller port as their active controller port.
4. The controller *max\_path\_count* value is the highest value that the controller *path\_count* has reached since it was last reset to the *path\_count* value. This value is reset by specific maintenance procedures and when the cluster error log is cleared.
5. The *allow\_quorum* value shows whether the controller is currently enabled to support quorum disks. Quorum support is either enabled or disabled depending on the controller hardware type.
6. The *ctrl\_s/n* value is the controller serial number. This data comes from vendor-controlled sources and might not be available.

#### **A concise invocation example**

```
lscontroller -delim :
```

#### **The concise resulting output**

```
id:controller_name:ctrl_s/n:vendor_id:product_id_low:product_id_high
7:controller7:3EK0J5Y8:SEAGATE :ST373405:FC
8:controller8:3EK0J6CR:SEAGATE :ST373405:FC
9:controller9:3EK0J4YN:SEAGATE :ST373405:FC
10:controller10:3EK0GKGH:SEAGATE :ST373405:FC
```

```
11:controller11:3EK0J85C:SEAGATE :ST373405:FC
12:controller12:3EK0JBR2:SEAGATE :ST373405:FC
13:controller13:3EKYNJF8:SEAGATE :ST373405:FC
14:controller14:3EK0HVTM:SEAGATE :ST373405:FC
```

### A detailed invocation example

```
lscontroller -delim = 7
```

### The detailed resulting output

```
id=7
controller_name=controller7
WWNN=20000004CF2412AC
mdisk_link_count=1
max_mdisk_link_count=1
degraded=no
vendor_id=SEAGATE
product_id_low=ST373405
product_id_high=FC
product_revision=0003
ctrl_s/n=3EK0J5Y8
allow_quorum=no
WWPN=22000004CF2412AC
path_count=1
max_path_count=1
WWPN=21000004CF2412AC
path_count=0
max_path_count=0
```

---

## lscontrollerdependentvdisks

The `lscontrollerdependentvdisks` command lists the volumes that are dependent on the specified controller.

### Syntax

```
▶▶ lscontrollerdependentvdisks — [controller_id_list | controller_name_list] ▶▶
```

### Parameters

*controller\_id\_list* | *controller\_name\_list*

Specifies one or more controller IDs, controller names, or both. Separate multiple controllers using the colon character (:).

### Description

The `lscontrollerdependentvdisks` command lists the volumes that are dependent on the status of the specified controllers. If a controller goes offline, the dependent volumes also go offline. Before taking a controller offline for maintenance, you can use the command to ensure that you do not lose access to any volumes.

If you have multiple controllers configured as a single subsystem, you must specify all of the controllers in the subsystem, using a single command invocation.

The `lscontrollerdependentvdisks` command also checks for quorum disks on the specified controller list. If any quorum disks are on the specified controller list, the command returns an error. All quorum disks must be moved before performing any maintenance. After moving quorum disks, reissue the command to list the dependent volumes.

**Note:** The command lists the volumes that are dependent on the controllers at the time the command is run; subsequent changes to your system require rerunning the command.

### An invocation example

```
lscontrollerdependentvdisks controller0
```

### The resulting output

```
vdisk_id vdisk_name
0 vdisk0
1 vdisk1
2 vdisk2
```

---

## lscurrentuser

Use the **lscurrentuser** command to display the name and role of the logged-in user.

### Syntax

```
▶▶ lscurrentuser — [-nohdr] [-delim delimiter] ▶▶
```

### Parameters

#### **-nohdr**

(Optional) By default, headings are displayed for each column of data in a concise style view, and for each item of data in a detailed style view. The **-nohdr** parameter suppresses the display of these headings.

**Note:** If there is no data to be displayed, headings are not displayed.

#### **-delim *delimiter***

(Optional) By default in a concise view, all columns of data are space-separated. The width of each column is set to the maximum possible width of each item of data. In a detailed view, each item of data has its own row, and if the headers are displayed, the data is separated from the header by a space. If you enter **-delim :** on the command line, the colon character (:) separates all items of data in a concise view; for example, the spacing of columns does not occur. In a detailed view, the data is separated from its header by the specified delimiter.

### Description

This command displays the name and role of the current user.

### An invocation example

```
lscurrentuser
```

### The resulting output

```
name superuser
role SecurityAdmin
```

---

## lsdiscoverystatus

Use the **lsdiscoverystatus** command to determine whether a discovery operation is in progress.



## Syntax

```
▶▶ lsdiscovrystatus — [-nohdr] [-delim — delimiter]
```

## Parameters

### -nohdr

(Optional) By default, headings are displayed for each column of data in a concise style view, and for each item of data in a detailed style view. The **-nohdr** parameter suppresses the display of these headings.

**Note:** If there is no data to be displayed, headings are not displayed.

### -delim *delimiter*

(Optional) By default in a concise view, all columns of data are space-separated. The width of each column is set to the maximum possible width of each item of data. In a detailed view, each item of data has its own row, and if the headers are displayed, the data is separated from the header by a space. The **-delim** parameter overrides this behavior. Valid input for the **-delim** parameter is a one-byte character. If you enter `-delim :` on the command line, the colon character (`:`) separates all items of data in a concise view; for example, the spacing of columns does not occur. In a detailed view, the data is separated from its header by the specified delimiter.

## Description

This command displays the state of all discoveries in the cluster. During discovery, the system updates the drive and MDisk records. You must wait until the discovery has finished and is inactive before you attempt to use the system. This command displays one of the following results:

**active** There is a discovery operation in progress at the time that the command is issued.

### inactive

There are no discovery operations in progress at the time that the command is issued.

If the Fibre Channel functions are used only to enable the nodes to cluster, then the Fibre Channel line will not be displayed in the **lsdiscovrystatus** command. The *fc\_fabric* line will only appear if there is at least one Fibre Channel controller.

## An invocation example

```
lsdiscovrystatus -delim :
```

## The resulting output

```
id:scope:IO_group_id:IO_group_name:status
0:fc_fabric:::active
1:sas_iogrp:0:io_grp0:inactive
3:sas_iogrp:2:io_grp2:active
```

---

## lsdumps

Use the **lsdumps** command to display a list of files in a particular dumps directory on one of the nodes in the cluster.

## Syntax

```
▶▶ lsdumps — [-nohdr] [-delim — delimiter] [-prefix — directory_name]
```

node\_id\_or\_name

## Parameters

### **-nohdr**

(Optional) By default, headings are displayed for each column of data in a concise style view, and for each item of data in a detailed style view. The **-nohdr** parameter suppresses the display of these headings.

**Note:** If there is no data to be displayed, headings are not displayed.

### **-delim delimiter**

(Optional) By default in a concise view, all columns of data are space-separated. The width of each column is set to the maximum possible width of each item of data. In a detailed view, each item of data has its own row, and if the headers are displayed, then the data is separated from the header by a space. The **-delim** parameter overrides this behavior. Valid input for the **-delim** parameter is a one-byte character. If you enter `-delim :` on the command line, the colon character (:) separates all items of data in a concise view; for example, the spacing of columns does not occur. In a detailed view, the data is separated from its header by the specified delimiter.

### **-prefix directory\_name**

(Optional) Specifies the name of the directory to list files for. The default is the `/dumps` directory. Valid directory names:

- `/dumps`
- `/dumps/audit`
- `/dumps/cimom`
- `/dumps/elogs`
- `/dumps/feature`
- `/dumps/iostats`
- `/dumps/iotrace`
- `/dumps/mdisk`
- `/home/admin/upgrade`
- `/dumps/drive`
- `/dumps/enclosure`

*node\_id\_or\_name*

(Optional) Specifies the node ID or name to list the available dumps for. If you do not specify a node, the available dumps on the configuration node are listed.

## Description

This command displays a list of files detected by a node. You can specify the name of the directory to list files for, and the node ID or name. If you do not specify a directory, the `/dumps` directory is used.

The files are listed in order of time created, with the oldest files listed first.

### An invocation example

To list the files in `/dumps` on the configuration node:

```
lsdumps
```

### The resulting output

```
id filename
0 svc.config.cron.bak_node1
1 svc.config.backup.xml_node1
2 recover.110584.100116.035201
3 dump.110584.100118.051550
4 ethernet.aaabbbX-1.trc
```

### An invocation example

To list the error log files on node 2:

```
lsdumps -prefix /dumps/elogs 2
```

### The resulting output

```
id filename
0 errlog_110584_090624_200258
1 errlog_110584_090717_231023
```

---

## lsemailer

The `lsemailer` command returns a concise list or a detailed view of email servers that are configured on the cluster.

### Syntax

```

▶▶ lsemailer [-nohdr] [-delim delimiter] [email_server_name | email_server_id]

```

### Parameters

#### **-nohdr**

(Optional) By default, headings are displayed for each column of data in a concise style view, and for each item of data in a detailed style view. The **-nohdr** parameter suppresses the display of these headings.

**Note:** If there is no data to be displayed, headings are not displayed.

#### **-delim *delimiter***

(Optional) By default in a concise view, all columns of data are space-separated. The width of each column is set to the maximum possible width of each item of data. In a detailed view, each item of data has its own row, and if the headers are displayed, the data is separated from the header by a space. The **-delim** parameter overrides this behavior. Valid input for the **-delim** parameter is a one-byte character. If you enter `-delim :` on the command line, the colon character (`:`) separates all items of data in a concise view; for example, the spacing of columns does not occur. In a detailed view, the data is separated from its header by the specified delimiter.

*email\_server\_name* | *email\_server\_id*

(Optional) Specifies the name or ID of an existing email server that must be listed.

### Description

Use this command to display a concise list or a detailed view of email servers that are configured on the cluster.

#### A concise invocation example

```
lsemailer -delim :
```

## The concise resulting output

```
id:name:IP_address:port
0:emailserver0:192.135.60.3:25
1:emailserver1:192.135.60.4:25
2:emailserver2:192.135.60.5:25
```

## A detailed invocation example

```
lsemailer email0
```

## The detailed resulting output

```
id 0
name emailserver0
IP_address 192.135.60.3
port 25
```

---

# lsemailer

The **lsemailer** command generates a report that lists the email event notification settings for all email recipients, an individual email recipient, or a specified type (local or support) of email recipient.

## Syntax

```
▶▶ lsemailer -type support | local -delim delimiter id_or_name ▶▶
```

## Parameters

### **-type support | local**

(Optional) Specifies the types of email recipients you want to view, either customer or support based as determined by the following definitions:

#### **support**

Address of the support organization that provides vendor support.

**local** All other addresses.

### **-delim delimiter**

(Optional) By default in a concise view, all columns of data are space separated. The width of each column is set to the maximum possible width of each item of data. In a detailed view, each item of data has its own row, and if the headers are displayed the data is separated from the header by a space. The **-delim** parameter overrides this behavior. Valid input for the **-delim** parameter is a one-byte character. If you enter **-delim :** on the command line, a colon separates all items of data in a concise view; the spacing of columns does not occur. In a detailed view, the data is separated from its header by a colon.

### *id\_or\_name*

(Optional) Specifies the user ID or user name of the email event recipient for whom you want to see the email notification settings.

## Description

When you issue this command, a report is displayed that lists the email event notification settings for all email recipients, an individual email recipient, or a specified type (local or support) of email recipient. The concise and detailed views report the same information.

## An invocation example

The following command lists information for all email recipients using the email event notification facility, in a concise view:

```
lsmailuser -delim :
```

### The resulting output

```
id:name:address:user_type:error:warning:info:inventory
1:Support:callhome1@de.ibm.com:support:on:off:off:off
2:Fred:fred_house@my_company.co.uk:local:on:on:on:off
3:Log:our_log@my_company.co.uk:local:on:on:on:on
```

---

## lsfabric

The **lsfabric** command generates a report that displays the Fibre Channel connectivity between nodes, controllers, and hosts.

### Syntax

```
▶▶— lsfabric —————▶▶
```

|             |                       |       |         |
|-------------|-----------------------|-------|---------|
| -node       | node_id_or_name       | -port | port_id |
| -wwpn       | wwpn                  |       |         |
| -host       | host_id_or_name       |       |         |
| -controller | controller_id_or_name |       |         |
| -cluster    | cluster_id_or_name    |       |         |

### Parameters

**-node** *node\_id\_or\_name*

(Optional) Displays the output for all ports for the specified node. The only parameter that you can specify with the **-node** parameter is the **-port** parameter.

**-port** *port\_id*

(Optional) Displays a concise view of all WWPNs that are logged into the specified port ID and node. The **-port** parameter must be specified with only the **-node** parameter. A valid *port\_id* value is a number from 1 - 4 that specifies the port number in the vital product data (VPD) or the hexadecimal WWPN of the local port.

**-wwpn** *wwpn*

(Optional) Displays a list of all ports that have a login to the specified WWPN. You cannot use the **-wwpn** parameter with any other parameter.

**-host** *host\_id\_or\_name*

(Optional) Specifies a host name or ID. Issuing the **lsfabric** command with the **-host** parameter is equivalent to issuing the **lsfabric -wwpn wwpn** command for every configured WWPN of the specified host. For example, a host with two ports that are zoned to one port of every node in a eight-node clustered system (system) produces 16 lines of output. You cannot use the **-host** parameter with any other parameter.

**-controller** *controller\_id\_or\_name*

(Optional) Specifies a controller ID or name. You cannot use the **-controller** parameter with any other parameter in this command. Issuing the **lsfabric** command with the **-controller** parameter is equivalent to issuing the **lsfabric -wwpn wwpn** command for every configured WWPN of the specified controller. For example, a controller with 4 ports connected to a 8 node system with 2 counterpart SANs produces 64 lines of output.

**-cluster** *cluster\_id\_or\_name*

(Optional) Specifies a system ID or name. You cannot use the **-cluster** parameter with any other parameter. Issuing the **lsfabric** command with the **-cluster** parameter is equivalent to issuing the

**lsfabric -wwpn** *wwpn* command for every known WWPN in the specified system. Output is sorted by remote WWPNs and then system WWPNs. This parameter can be used to check the state of connections within the local system or between the local and remote system. When the local system ID or name is specified, each node-to-node connection is listed twice: once from each end. For example, an eight-node system with two counterpart SANs produces eight nodes, multiplied by seven other nodes, multiplied by two SANs, multiplied by four point-to-point logins, equals 448 lines of output.

**Note:** The system must be configured in a remote copy partnership with the local system; it must appear in the **lscluster** view.

## Description

The **lsfabric** command can be issued with any of the parameters to display a limited subset of information. If the command is issued without any parameters, it provides output for every node.

Values for the **Type** and **State** columns are:

### state active

The meaning of this value depends on the object that it applies to, as follows:

- **host or controller:** SCSI commands were issued within the last 5 minutes.
- **node:** node ports can see other ports.

### state inactive

No transactions have completed within the last 5 minutes.

**Note:** It can take up to 10 seconds after a command for a controller port to change from inactive to active. It can take up to 5 minutes after a command for a host port to change from inactive to active.

**type** One of the following values is displayed:

- **host**
- **node**
- **controller**
- **unknown**

You can issue this command to view all the information about the connections that are available to your system.

### An invocation example

```
lsfabric -delim :
```

**The resulting output** Each row of output contains the following colon-separated columns:

```
remote_wwpn:remote_nportid:id:node_name:local_wwpn:
local_port:local_nportid:state:name:cluster_name:type
```

---

## lsfcconsistgrp

The **lsfcconsistgrp** command returns a concise list or a detailed view of FlashCopy consistency groups that are visible to the cluster. This information is useful for tracking FlashCopy consistency groups.

The list report style can be used to obtain two styles of report:

- A list containing concise information about all of the FlashCopy consistency groups on a cluster. (Each entry in the list corresponds to a single FlashCopy consistency group.)
- The detailed information about a single FlashCopy consistency group.

## Syntax

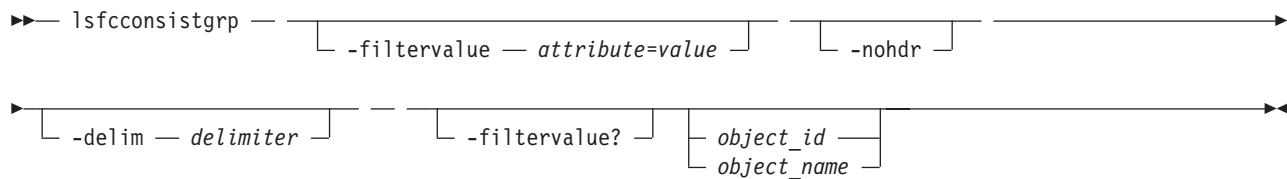

## Parameters

### **-filtervalue** *attribute=value*

(Optional) Specifies a list of one or more filters. Only objects with a value that matches the filter attribute value are returned.

**Note:** Some filters allow the use of a wildcard when you enter the command. The following rules apply to the use of wildcards with the SAN Volume Controller CLI:

- The wildcard character is an asterisk character (\*).
- The command can contain a maximum of one wildcard, which must be the first or last character in the string.
- When you use a wildcard, surround the filter entry with double quotation marks (""), as follows:

```
lsfcconsistgrp -filtervalue "name=md*"
```

### **-nohdr**

(Optional) By default, headings are displayed for each item of data in a concise view. The **-nohdr** parameter suppresses the display of these headings. Detailed view is not valid for this command.

**Note:** If there is no data to be displayed, headings are not displayed.

### **-delim** *delimiter*

(Optional) By default in a concise view, all columns of data are space-separated. The width of each column is set to the maximum possible width of each item of data. In a detailed view, each item of data has its own row, the headers are displayed, and the data is separated from the header by a space. The **-delim** parameter overrides this behavior. Valid input for the **-delim** parameter is a one byte character. If you enter **-delim :** on the command line, the colon character (:) separates all items of data in a concise view; the spacing of columns does not occur. In a detailed view, the data is separated from its header by the specified delimiter.

### *object\_id* | *object\_name*

(Optional) Specifies the name or ID of an object. When you use this parameter, the detailed view of the specific object is returned and any value that is specified by the **-filtervalue** parameter returns an error message. If you do not specify the *object\_id* or *object\_name* parameter, the concise view of all objects matching the filtering requirements that is specified by the **-filtervalue** parameter are displayed.

### **-filtervalue?**

(Optional) Displays the list of valid filter attributes in the report. The valid filter attributes for the **lsfcconsistgrp** command are:

- **name**
- **id**
- **status**
- **FC\_group\_id**

## Description

This command returns a concise list or a detailed view of FlashCopy consistency groups that are visible to the cluster.

The following list provides values of the *status* attribute that are displayed as data in the output views:

*status* **empty, idle\_or\_copied, preparing, prepared, copying, stopped, suspended, stopping**

### A concise invocation example

```
lsfcconsistgrp -delim :
```

### The concise resulting output

```
id:name:status
1:ffccg0:empty
2:ffccg1:idle_or_copied
3:ffccg2:idle_or_copied
```

### A detailed invocation example

```
lsfcconsistgrp -delim : 1
```

### The detailed resulting output

```
id:1
name:ffccg0
status:empty
```

### A detailed invocation example

```
lsfcconsistgrp -delim : fcstgrp0
```

### The detailed resulting output

```
id:1
name:FCcgrp0
status:idle_or_copied
autodelete:off
FC_mapping_id:0
FC_mapping_name:fcmap0
FC_mapping_id:1
FC_mapping_name:fcmap1
```

---

## lsfcmap

The **lsfcmap** command generates a list containing concise information about all of the FlashCopy mappings that are visible to the cluster, or detailed information for a single FlashCopy mapping.

## Syntax

```
lsfcmap [-filtervalue — attribute=value] [-nohdr]
[-delim — delimiter] [-filtervalue?] [object_id]
[object_name]
```



## Parameters

### **-filtervalue** *attribute=value*

(Optional) Specifies a list of one or more filters. Only objects with a value that matches the filter attribute value are displayed.

**Note:** Some filters allow the use of a wildcard when you enter the command. The following rules apply to the use of wildcards with the SAN Volume Controller CLI:

- The wildcard character is the asterisk (\*), which must be used as the first or last character in the string.
- The command can contain a maximum of one wildcard.
- When you use a wildcard, enclose the filter entry within double quotation marks (""), as follows:

```
lsfcmap -filtervalue "name=md*"
```

### **-filtervalue?**

(Optional) Displays the valid filter attributes for the **-filtervalue** *attribute=value* parameter:

- name
- id
- source\_vdisk\_id
- source\_vdisk\_name
- target\_vdisk\_id
- target\_vdisk\_name
- group\_name
- group\_id
- status
- copy\_rate
- FC\_mapping\_name
- FC\_id
- partner\_FC\_id
- partner\_FC\_name
- restoring

### **-nohdr**

(Optional) By default, headings are displayed for each column of data in a concise style view, and for each item of data in a detailed style view. The **nohdr** parameter suppresses the display of these headings.

**Note:** If there is no data to be displayed, headings are not displayed.

### **-delim** *delimiter*

(Optional) By default in a concise view, all columns of data are space-separated. The width of each column is set to the maximum possible width of each item of data. In a detailed view, each item of data has its own row, and if the headers are displayed the data is separated from the header by a space. The **delim** parameter overrides this behavior. Valid input for the **delim** parameter is a one-byte character. If you enter **-delim :** on the command line, the colon character (:) separates all items of data in a concise view; for example, the spacing of columns does not occur. In a detailed view, the data is separated from its header by the specified delimiter.

### *object\_id* | *object\_name*

(Optional) Specifies the name or ID of an object. When you use this parameter, the detailed view of the specific object is returned and any value that is specified by the **filtervalue** parameter is ignored. If you do not specify the **object\_ID** or **object\_name** parameter, the concise view of all objects matching the filtering requirements that is specified by the **filtervalue** parameter are displayed.

## Description

This command returns a concise list or a detailed view of FlashCopy mappings that are visible to the cluster.

The following list shows attribute values that can be displayed as output view data:

**status** idle\_or\_copied, preparing, prepared, copying, stopped, suspended or stopping

**start\_time**

Displays the time that the copy was last started. It is in the format *YYMMDDHHMMSS*. If a copy has not been started, a blank line is displayed.

### A concise invocation example

```
lsfcmap -delim :
```

### The concise resulting output

```
id:name:source_vdisk_id:source_vdisk_name:target_vdisk_id:target_vdisk_name:
group_id:group_name:status:progress:copy_rate:clean_progress:incremental:
partner_FC_id:partner_FC_name:restoring
0:fcmap0:0:vdisk0:1:vdisk1:0:fccstgrp0:idle_or_copied:0:50:0:on:2:fcmap2:no
1:fcmap1:2:vdisk2:3:vdisk3:0:fccstgrp0:idle_or_copied:0:0:100:off:::no
2:fcmap2:1:vdisk1:0:vdisk0:0:fccstgrp1:idle_or_copied:0:0:100:off:0:fcmap0:no
```

### A detailed invocation example

```
lsfcmap -delim : 0
```

### The detailed resulting output

```
id:0
name:fcmap0
source_vdisk_id:63
source_vdisk_name:vdisk63
target_vdisk_id:57
target_vdisk_name:vdisk57
group_id:
group_name:
status:idle_or_copied
progress:0
copy_rate:0
start_time:
dependent_mappings:0
autodelete:off
clean_progress:100
clean_rate:50
incremental:off
difference:100
grain_size:256
IO_group_id:1
IO_group_name:io_grp1
partner_FC_id:
partner_FC_name:
restoring:no
```

---

## lsfcmapcandidate

The **lsfcmapcandidate** command lists all of the VDisks that are associated with fewer than 256 FlashCopy mappings.

## Syntax

```
►► svcinfo — — lsfcmapcandidate — [-nohdr] [-delim — delimiter]
```

## Parameters

### **-nohdr**

(Optional) By default, the heading is displayed for the column of data in a concise style view, and for the item of data in a detailed style view. The **-nohdr** parameter suppresses the display of the heading.

**Note:** If there is no data to be displayed, headings are not displayed.

### **-delim delimiter**

(Optional) By default in a concise view, all columns of data are space-separated. The width of each column is set to the maximum possible width of each item of data. In a detailed view, each item of data has its own row, and if the headers are displayed, the data is separated from the header by a space. The **-delim** parameter overrides this behavior. Valid input for the **-delim** parameter is a one-byte character. If you enter **-delim :** on the command line, a colon character (:) separates all items of data in a concise view; the spacing of columns does not occur. In a detailed view, the data is separated from its header by the specified delimiter.

## Description

This command returns a list of VDisks that are associated with fewer than 256 FlashCopy mappings.

### An invocation example

```
svcinfo lsfcmapcandidate
```

### The resulting output

```
id
2
3
4
```

---

## lsfcmapprogress

The **lsfcmapprogress** command returns the progress of the background copy of a FlashCopy mapping. This is displayed as a percentage completed value.

## Syntax

```
►► lsfcmapprogress — [-nohdr] [-delim — delimiter] [fcmapping_id — fcmapping_name]
```

## Parameters

### **-nohdr**

(Optional) By default, headings are displayed for each item of data in a detailed style view. The **-nohdr** parameter suppresses the display of these headings.

**Note:** If there is no data to be displayed, headings are not displayed.

### **-delim delimiter**

(Optional) By default, all columns of data are space-separated. The width of each column is set to the maximum possible width of each item of data. In a detailed view, each item of data has its own row,

and if the headers are displayed the data is separated from the header by a space. The **-delim** parameter overrides this behavior. Valid input for the **-delim** parameter is a one byte character. If you enter `-delim :` on the command line, the data is separated from its header by a colon character (`:`).

*fcmap\_id* | *fcmap\_name*

(Required) Specifies that you want the report to display the progress of the background copy for the designated FlashCopy mapping.

## Description

This command reports a percentage for the progress of the background copy being done on the specified FlashCopy mapping.

### An invocation example

```
lsfcmapprogress 0
```

### The resulting output

```
id progress
0 0
```

---

## lsfcmapdependentmaps

The `lsfcmapdependentmaps` command displays all the FlashCopy mappings that are dependent on the user specified mapping.

## Syntax

```
lsfcmapdependentmaps [-nohdr] [-delim delimiter] [fc_id | fc_name]
```

## Parameters

### **-nohdr**

(Optional) By default, headings are displayed for each column of data in a concise style view, and for each item of data in a detailed style view. The **-nohdr** parameter suppresses the display of these headings.

**Note:** If there is no data to be displayed, headings are not displayed.

### **-delim** *delimiter*

(Optional) By default in a concise view, all columns of data are space-separated. The width of each column is set to the maximum possible width of each item of data. In a detailed view, each item of data has its own row, and if the headers are displayed the data is separated from the header by a space. The **-delim** parameter overrides this behavior. Valid input for the **-delim** parameter is a one byte character. If you enter `-delim :` on the command line, the colon character (`:`) separates all items of data in a concise view; for example, the spacing of columns does not occur. In a detailed view, the data is separated from its header by the specified delimiter.

*fc\_id* | *fc\_name*

(Required) Specifies the name or ID of the FlashCopy mapping to list the dependent maps for.

## Description

This command returns a list of dependent FlashCopy mappings. This command can be used to determine the list of FlashCopy mappings that would also stop if you stopped a mapping using the **-force** parameter.

There is a `dependent_mapping_count` field in the FlashCopy map detailed view (displayed when you process the `lsfcmap` command) that you can use as an indicator as to whether there are any dependent mappings in progress. If the count is zero, there are no dependent copies.

**Note:** If a period of time elapses between the time you process the `lsfcmap` command and the `lsfcmapdependentmaps` command, there could be a difference between the actual number of dependent mappings being processed and the number that was reported by the `lsfcmap` command.

### A concise invocation example

```
lsfcmapdependentmaps -delim : 2
```

### The resulting output

```
fc_id:fc_name
1:fcmap1
3:fcmap3
```

---

## lsfeaturedumps (Deprecated)

**Attention:** The `svcinfolssfeaturedumps` command is deprecated. Use the `svcinfolssdumps` command to display a list of files in a particular dumps directory.

---

## lsfreeextents

The `lsfreeextents` command lists the number of free extents that are available on a specified MDisk.

### Syntax

```
▶▶— lsfreeextents — [-nohdr] [-delim delimiter] [mdisk_id | mdisk_name] ▶▶
```

### Parameters

#### **-nohdr**

(Optional) By default, headings are displayed for each column of data in a concise style view, and for each item of data in a detailed style view. The **-nohdr** parameter suppresses the display of these headings.

**Note:** If there is no data to be displayed, headings are not displayed.

#### **-delim *delimiter***

(Optional) By default in a concise view, all columns of data are space-separated. The width of each column is set to the maximum possible width of each item of data. In a detailed view, each item of data has its own row, and if the headers are displayed, the data is separated from the header by a space. The **-delim** parameter overrides this behavior. Valid input for the **-delim** parameter is a one-byte character. If you enter `-delim :` on the command line, the colon character (`:`) separates all items of data in a concise view; for example, the spacing of columns does not occur. In a detailed view, the data is separated from its header by the specified delimiter.

#### *mdisk\_id* | *mdisk\_name*

(Required) Specifies the ID or the name of the MDisk for which you want to know the number of free extents.

## Description

This command displays a count of the number of free extents on the specified MDisk.

### An invocation example

```
lsfreeextents 2
```

### The resulting output

```
id 2
number_of_extents 4372
```

---

## Ishbaportcandidate

The **Ishbaportcandidate** command lists all of the unconfigured, logged-in host bus adapter (HBA) ports. This information is used to find open HBA ports.

## Syntax

```
➤ — Ishbaportcandidate — [-nohdr] [-delim delimiter] —➤
```

## Parameters

### -nohdr

(Optional) By default, headings are displayed for each column of data in a concise style view, and for each item of data in a detailed style view. The **-nohdr** parameter suppresses the display of these headings.

**Note:** If there is no data to be displayed, headings are not displayed.

### -delim *delimiter*

(Optional) By default in a concise view, all columns of data are space-separated. The width of each column is set to the maximum possible width of each item of data. In a detailed view, each item of data has its own row, and if the headers are displayed the data is separated from the header by a space. The **-delim** parameter overrides this behavior. Valid input for the **-delim** parameter is a one-byte character. If you enter **-delim :** on the command line, the colon character (:) separates all items of data in a concise view; for example, the spacing of columns does not occur. In a detailed view, the data is separated from its header by the specified delimiter.

## Description

This command returns a list of unconfigured, logged in HBA ports.

**Note:** The **Ishbaportcandidate** command presents a list of host HBA ports that are logged in to nodes. However, there are situations when the information that is presented might include host HBA ports that are no longer logged in or even part of the SAN fabric. For example, a host HBA port is unplugged from a switch but **Ishbaportcandidate** still shows the WWPN that is logged in to all nodes. If this occurs, the incorrect entry is removed when another device is plugged in to the same switch port that previously contained the removed host HBA port.

### An invocation example

```
Ishbaportcandidate
```

### The resulting output

```
id
210100E08B2520D4
```

---

## lshost

The **lshost** command generates a list with concise information about all the hosts visible to the cluster and detailed information about a single host.

### Syntax

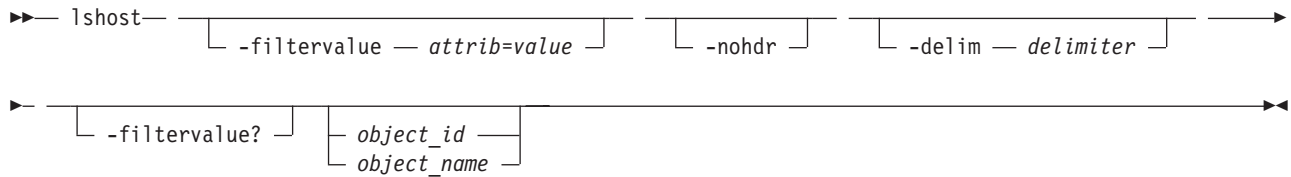

### Parameters

#### **-filtervalue** *attrib=value*

(Optional) Specifies a list of one or more filters. Only objects with a value that matches the filter attribute value are returned. If a capacity is specified, the units must also be included.

**Note:** Some filters allow the use of a wildcard when you enter the command. The following rules apply to the use of wildcards with the SAN Volume Controller CLI:

- The wildcard character is an asterisk (\*).
- The command can contain a maximum of one wildcard.
- When using a wildcard character, you must enclose the filter entry within double quotation marks (" "), as follows:

```
lshost -filtervalue "name=md*"
```

#### **-nohdr**

(Optional) By default, headings are displayed for each column of data in a concise style view, and for each item of data in a detailed style view. The **-nohdr** parameter suppresses the display of these headings.

**Note:** If there is no data to be displayed, headings are not displayed.

#### **-delim** *delimiter*

(Optional) By default in a concise view, all columns of data are space-separated. The width of each column is set to the maximum possible width of each item of data. In a detailed view, each item of data has its own row, and if the headers are displayed the data is separated from the header by a space. The **-delim** parameter overrides this behavior. Valid input for the **-delim** parameter is a one-byte character. If you enter **-delim :** on the command line, the colon character (:) separates all items of data in a concise view; for example, the spacing of columns does not occur. In a detailed view, the data is separated from its header by the specified delimiter.

#### *object\_id* | *object\_name*

(Optional) Specifies the name or ID of an object. When you use this parameter, the detailed view of the specific object is returned and any value that is specified by the **-filtervalue** parameter is ignored. If you do not specify the *object\_id* | *object\_name* parameter, the concise view of all objects matching the filtering requirements that is specified by the **-filtervalue** parameter are displayed.

#### **-filtervalue?**

(Optional) Specifies that you want your report to display any or all of the list of valid filter attributes. The valid filter attributes for the **lshost** command are:

- host\_name
- host\_id
- port\_count

- name
- id
- iogrp\_count

## Description

This command returns a concise list or a detailed view, of hosts visible to the cluster.

For Fibre Channel ports, the `nodes_logged_in_count` field provides the number of nodes that the host port is logged into. For iSCSI ports, the `nodes_logged_in_count` field provides the number of iSCSI sessions (a maximum of four) from the host iSCSI Qualified Name (IQN).

The following list provides the different states for a host:

**active** The host is active if all the nodes with VDisk mappings have a login for the specified WWPN, however, at least one node has seen SCSI commands from the WWPN in the last 5 minutes.

### degraded

The host is degraded if one or more nodes with VDisk mappings do not have a login for the specified WWPN.

### inactive

The host is inactive if all the nodes with VDisk mappings have a login for the specified WWPN, however, no nodes have seen any SCSI commands from the WWPN in the last 5 minutes.

### offline

The host is offline if one or more I/O groups with VDisk (volume) mappings do not have a login for the specified WWPN.

**Note:** iSCSI hosts are always displayed in an offline state, even when they are functioning correctly. This is a current limitation for iSCSI hosts.

If a host does not have any VDisk mappings, then it is either reported as offline or inactive.

**Note:** The `lshost` command presents a list of host HBA ports that are logged in to nodes. However, there are situations when the information presented can include host HBA ports that are no longer logged in or even part of the SAN fabric. For example: A host HBA port is unplugged from a switch, but `lshost` still shows the WWPN logged in to all nodes. If this occurs, the incorrect entry is removed when another device is plugged in to the same switch port that previously contained the removed host HBA port.

## A concise invocation example

```
lshost
```

### The concise resulting output

| id | name      | port_count | iogrp_count |
|----|-----------|------------|-------------|
| 0  | mchost20  | 1          | 4           |
| 1  | mchost30  | 1          | 4           |
| 2  | mchost200 | 1          | 4           |
| 3  | mchost40  | 1          | 4           |
| 4  | mchost240 | 1          | 4           |
| 5  | mchost170 | 1          | 4           |
| 6  | mchost120 | 1          | 4           |
| 7  | mchost60  | 1          | 4           |
| 8  | mchost180 | 1          | 4           |
| 9  | mchost13  | 2          | 4           |

## A detailed invocation example

```
lshost mchost13
```



## The detailed resulting output

```
id 9
name mchost13
port_count 2
type generic
mask 1111
iogrp_count 4
iscsiname mc13host
node_logged_in_count 0
state offline
iscsiname mchost13
node_logged_in_count 0
state offline
```

---

## lshostiogrp

The `lshostiogrp` command displays a list of all the I/O groups that are associated with a specified host.

### Syntax

```
▶▶ lshostiogrp — [-nohdr] [-delim delimiter] [host_id | host_name] ▶▶
```

### Parameters

#### **-nohdr**

(Optional) By default, headings are displayed for each column of data in a concise style view, and for each item of data in a detailed style view. The **-nohdr** parameter suppresses the display of these headings.

**Note:** If there is no data to be displayed, headings are not displayed.

#### **-delim** *delimiter*

(Optional) By default in a concise view, all columns of data are space-separated. The width of each column is set to the maximum possible width of each item of data. In a detailed view, each item of data has its own row, and if the headers are displayed, the data is separated from the header by a space. The **-delim** parameter overrides this behavior. Valid input for the **-delim** parameter is a one-byte character. If you enter `-delim :` on the command line, the colon character (`:`) separates all items of data in a concise view; for example, the spacing of columns does not occur. In a detailed view, the data is separated from its header by the specified delimiter.

*host\_id* | *host\_name*

(Required) The name or ID of the host for which the list of I/O groups is required.

### Description

This command displays a list of all the I/O groups that are mapped to the specified host.

#### An invocation example

```
lshostiogrp -delim : hostone
```

#### The resulting output

```
id:name
0:io_grp0
1:io_grp1
```

---

## lshostvdiskmap

The **lshostvdiskmap** command displays a list of volumes that are mapped to a given host. These are the volumes that are recognized by the specified host.

### Syntax

```
lshostvdiskmap [-nohdr] [-delim delimiter] [host_id | host_name]
```

### Parameters

#### **-nohdr**

(Optional) By default, headings are displayed for each column of data in a concise style view, and for each item of data in a detailed style view. The **-nohdr** parameter suppresses the display of these headings.

**Note:** If there is no data to be displayed, headings are not displayed.

#### **-delim delimiter**

(Optional) By default in a concise view, all columns of data are space-separated. The width of each column is set to the maximum possible width of each item of data. In a detailed view, each item of data has its own row, and if the headers are displayed, the data is separated from the header by a space. The **-delim** parameter overrides this behavior. Valid input for the **-delim** parameter is a one-byte character. If you enter **-delim :** on the command line, the colon character (:) separates all items of data in a concise view; for example, the spacing of columns does not occur. In a detailed view, the data is separated from its header by the specified delimiter.

#### *host\_id | host\_name*

(Optional) Specifies the host in terms of its ID or name. The command displays a list of all the virtual disks that are mapped to the specified host and the SCSI ID by which they are mapped. If neither a host ID or name are entered, the command displays a list of all recognized host-to-volume mappings.

### Description

This command displays a list of volume IDs and names. These are the volumes that have been mapped to the specified host; that is, they are visible to the specified host. The SCSI LUN ID is also displayed. This SCSI LUN ID is the ID by which the volume is recognized by the host.

Each volume that is exported by the clustered system is assigned a unique vpath number. This number identifies the volume and determines which volume corresponds to the volume that the hosts recognize. This procedure can only be performed using the command-line interface.

For the specified volume, find the vpath serial number by issuing the **datapath query device** command. Find the host that is defined to the clustered system that corresponds with the host that you are working with.

1. The WWPNs are an attribute of the HBA. You can find these by looking at the device definitions stored by your operating system. For example, on AIX they are in the ODM, in Windows they are in the Device Manager details for the given HBA.
2. Verify which host is defined to the clustered system that these ports belong to. The ports are stored as part of the detailed view, so you must list each host in turn by issuing the following command:

```
lshost host_name | host_id
```

where *host\_name | host\_id* is the name or ID of the host. Check for matching WWPNs.



**-nohdr**

(Optional) By default, headings are displayed for each column of data in a concise style view, and for each item of data in a detailed style view. The **-nohdr** parameter suppresses the display of these headings.

**-delim *delimiter***

(Optional) By default in a concise view, all columns of data are space-separated. The width of each column is set to the maximum possible width of each item of data. In a detailed view, each item of data has its own row, and if the headers are displayed the data is separated from the header by a space. The **-delim** parameter overrides this behavior. Valid input for the **-delim** parameter is a one byte character. If you enter **-delim :** on the command line, the colon character (:) separates all items of data in a concise view; for example, the spacing of columns does not occur. In a detailed view, the data is separated from its header by the specified delimiter.

**-filtervalue?**

(Optional) Displays the valid filter attributes for the **lsiogrp** command:

- **HWS\_name**
- **HWS\_unique\_id**
- **node\_count**
- **name**
- **id**
- **host\_count**

**-bytes**

(Optional) Displays all capacities as bytes.

***object\_id* | *object\_name***

(Optional) Specifies the name or ID of an object. When you use this parameter, the detailed view of the specific object is returned and any value that is specified by the **-filtervalue** parameter is ignored. If you do not specify the *object\_id* | *object\_name* parameter, the concise view of all objects matching the filtering requirements that is specified by the **-filtervalue** parameter are displayed.

**-maintenance *yes* | *no***

(Optional) Specifies whether the I/O group should be in maintenance mode. The I/O group should be placed in maintenance mode while carrying out service procedures on storage enclosures. Once you enter maintenance mode, it continues until either:

- It is explicitly cleared, OR
- 30 minutes elapse

## Description

This command returns a concise list or a detailed view of I/O groups visible to the cluster.

You can display the following information for this command:

**raid\_total\_memory**

Total bitmap space available for RAID arrays (in MB with 1 decimal place).

**raid\_free\_memory**

Bitmap space available for creating new RAID arrays (in MB with 1 decimal place).

### A concise invocation example

```
lsiogrp -delim :
```

### The concise resulting output

```
id:name:node_count:vdisk_count:host_count
0:io_grp0:1:0:0
1:io_grp1:0:0:0
2:io_grp2:0:0:0
3:io_grp3:0:0:0
4:recovery_io_grp:0:0:0
```

### A detailed invocation example

```
lsiogrp -delim : 0
```

### The detailed resulting output

```
id:0
name:io_grp0
node_count:1
vdisk_count:51
host_count:0
flash_copy_total_memory:3.0MB
flash_copy_free_memory:1.0MB
remote_copy_total_memory:6.5MB
remote_copy_free_memory:2.8MB
mirroring_total_memory:1.0MB
mirroring_free_memory:0.3MB
maintenance:no
```

---

## Isiogrpghost

The **Isiogrpghost** command displays a list of the hosts that are mapped to a specified I/O group.

### Syntax

```
▶▶ — lsiogrpghost — [-nohdr] [-delim — delimiter] [iogrp_id | iogrp_name] ▶▶
```

### Parameters

#### **-nohdr**

(Optional) By default, headings are displayed for each column of data in a concise style view, and for each item of data in a detailed style view. The **-nohdr** parameter suppresses the display of these headings.

**Note:** If there is no data to be displayed, headings are not displayed.

#### **-delim *delimiter***

(Optional) By default in a concise view, all columns of data are space-separated. The width of each column is set to the maximum possible width of each item of data. In a detailed view, each item of data has its own row, and if the headers are displayed, the data is separated from the header by a space. The **-delim** parameter overrides this behavior. Valid input for the **-delim** parameter is a one-byte character. If you enter `-delim :` on the command line, the colon character (:) separates all items of data in a concise view; for example, the spacing of columns does not occur. In a detailed view, the data is separated from its header by the specified delimiter.

*iogrp\_id* | *iogrp name*

(Required) The ID or name of the I/O group for which a list of all mapped hosts is required.

## Description

The **lsiogrphost** command displays a list of hosts that are mapped to a specified I/O group.

### An invocation example

```
lsiogrphost -delim : 0
```

### The resulting output

```
id:name
0:hostzero
1:hostone
```

---

## lsiogrpcandidate

Use the **lsiogrpcandidate** command to list the I/O groups that can have nodes added to them.

## Syntax

```
▶▶ lsiogrpcandidate — [-nohdr] [-delim delimiter] ▶▶
```

## Parameters

### -nohdr

(Optional) By default, headings are displayed for each column of data in a concise style view, and for each item of data in a detailed style view. The **-nohdr** parameter suppresses the display of these headings.

**Note:** If there is no data to be displayed, headings are not displayed.

### -delim *delimiter*

(Optional) By default in a concise view, all columns of data are space-separated. The width of each column is set to the maximum possible width of each item of data. In a detailed view, each item of data has its own row, and if the headers are displayed, the data is separated from the header by a space. The **-delim** parameter overrides this behavior. Valid input for the **-delim** parameter is a one-byte character. If you enter **-delim :** on the command line, the colon character (:) separates all items of data in a concise view; for example, the spacing of columns does not occur. In a detailed view, the data is separated from its header by the specified delimiter.

## Description

This command displays a list of I/O groups to which nodes can be added. Only the I/O group IDs are displayed.

### An invocation example

```
lsiogrpcandidate
```

### The resulting output

```
id
0
1
2
3
4
```

---

## Isiostatsdumps (Deprecated)

**Attention:** The `svcinfolisiostatsdumps` command is deprecated. Use the `svcinfolsdumps` command to display a list of files in a particular dumps directory.

---

## Isiotracedumps (Deprecated)

**Attention:** The `svcinfolsiotracedumps` command is deprecated. Use the `svcinfolsdumps` command to display a list of files in a particular dumps directory.

---

## Isiscsiauth

The `Isiscsiauth` command lists the Challenge Handshake Authentication Protocol (CHAP) secret configured for authenticating an entity to the SAN Volume Controller cluster.

### Syntax

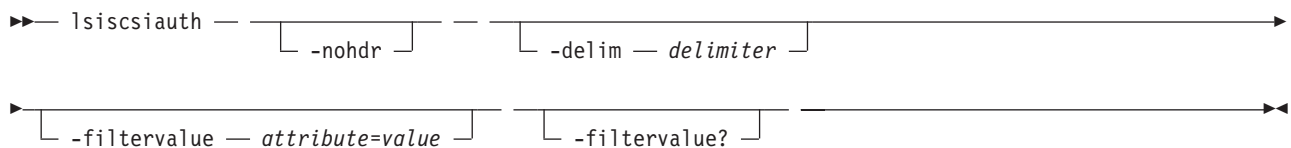

### Parameters

#### **-nohdr**

(Optional) By default, headings are displayed for each column of data in a concise style view, and for each item of data in a detailed style view. The **-nohdr** parameter suppresses the display of these headings.

**Note:** If there is no data to be displayed, headings are not displayed.

#### **-delim delimiter**

(Optional) By default in a concise view, all columns of data are space-separated. The width of each column is set to the maximum possible width of each item of data. In a detailed view, each item of data has its own row, and if the headers are displayed, the data is separated from the header by a space. The **-delim** parameter overrides this behavior. Valid input for the **-delim** parameter is a one-byte character. If you enter `-delim :` on the command line, the colon character (`:`) separates all items of data in a concise view; for example, the spacing of columns does not occur. In a detailed view, the data is separated from its header by the specified delimiter.

#### **-filtervalue attribute=value**

(Optional) Specifies a list of one or more filters. Only objects with a value that matches the filter attribute value are displayed. If a capacity is specified, the units must also be included.

**Note:** Some filters allow the asterisk character (`*`) when you enter the command. The following rules apply to the use of wildcard characters with the SAN Volume Controller CLI:

- The wildcard character is an asterisk (`*`).
- The command can contain a maximum of one wildcard.
- When you use a wildcard, you must enclose the filter entry within double quotation marks (`"`), as follows:

```
Isiscsiauth -filtervalue "name=md*"
```

#### **-filtervalue?**

(Optional) displays a list of filters that can be applied against this view. The following filter attributes are valid for the `Isiscsiauth` command:

- **type**
- **id**
- **name**
- **iscsi\_auth\_method**
- **iscsi\_chap\_secret**

## Description

This command lists the CHAP secret configured for authenticating an entity to the SAN Volume Controller cluster. The command also displays the configured iSCSI authentication method. The `iscsi_auth_method` field can have values of `none` or `chap`.

When you create an iSCSI host using the `mkhost` command with the `iscsiname` parameter, the host is initially configured with the authentication method as `none`, and no CHAP secret is set. To set a CHAP secret for authenticating the iSCSI host with the SAN Volume Controller cluster, use the `chhost` command with the `chapsecret` parameter.

### A invocation example

```
lscsiasauth
```

### The resulting output

| type | id | name     | iscsi_auth_method | iscsi_chap_secret |
|------|----|----------|-------------------|-------------------|
| host | 0  | mhost20  | none              |                   |
| host | 1  | mhost30  | none              |                   |
| host | 2  | mhost200 | none              |                   |
| host | 3  | mhost40  | none              |                   |
| host | 4  | mhost240 | none              |                   |
| host | 5  | mhost170 | none              |                   |
| host | 6  | mhost120 | none              |                   |
| host | 7  | mhost60  | none              |                   |
| host | 8  | mhost180 | none              |                   |
| host | 9  | mhost13  | none              |                   |
| host | 10 | newhost  | none              |                   |

---

## lslicense

The `lslicense` command displays current license settings for cluster features.

### Syntax

```

>> lslicense — [-nohdr] [-delim delimiter]

```

### Parameters

#### **-nohdr**

(Optional) Suppresses the display of these headings. By default, headings are displayed for each column of data (in a concise style view providing general information about objects of a particular type) and for each item of data (in a detailed style view providing much more information about a specific object of a particular type).

**Note:** If there is no data to be displayed, headings are not displayed.

#### **-delim *delimiter***

(Optional) By default in a concise view, all columns of data are space-separated. The width of each column is set to the maximum possible width of each item of data. In a detailed view, each item of



data has its own row, and if the headers are displayed, the data is separated from the header by a space. The **-delim** parameter overrides this behavior. Valid input for the **-delim** parameter is a one-byte character. If you enter **-delim :**, a colon character (:) separates all items of data in a concise view; for example, the spacing of columns does not occur. In a detailed view, the data is separated from its header by the specified delimiter.

## Description

The **lslicense** command displays license settings for cluster features, including remote copy and virtualization settings. SAN Volume Controller also includes FlashCopy settings. The displayed output for SAN Volume Controller lists capacity values in terabytes (TB) and feature enablement. The displayed output for Storwize V7000 lists enclosure license values.

Use the **chlicense** command to change the feature license settings. Because the feature license settings are entered when the cluster is first created, you must only update the settings if you have changed your license.

### An invocation example

```
lslicense
```

### The resulting output

```
used_flash 0.00
used_remote 0.00
used_virtualization 0.00
license_flash 0
license_remote 20
license_virtualization 30
license_physical_disks 0
license_physical_flash off
license_physical_remote off
```

---

## lsmdisk

The **lsmdisk** command returns a concise list or a detailed view of managed disks (MDisks) visible to the cluster. It can also list detailed information about a single MDisk.

## Syntax

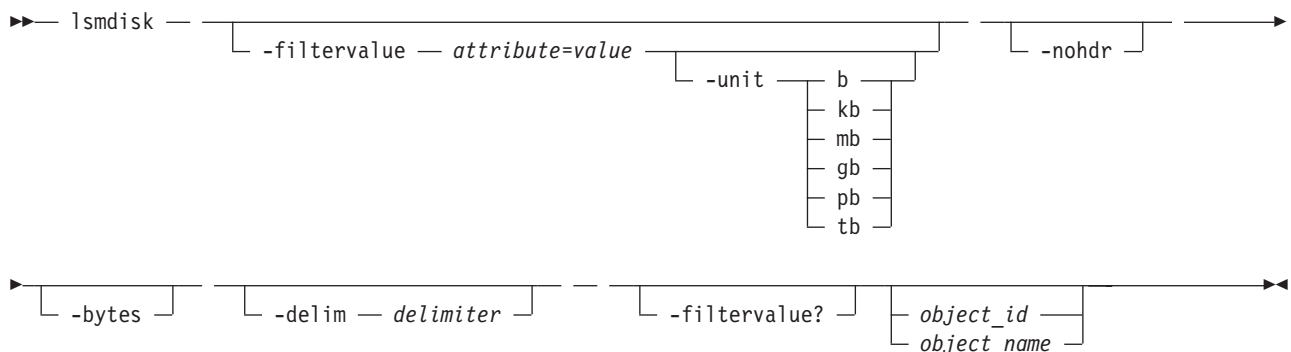

## Parameters

**-filtervalue** *attribute=value*

(Optional) Specifies a list of one or more filter attributes matching the specified values; see **-filtervalue?** for the supported attributes. Only objects with a value that matches the filter attribute value are returned. If **capacity** is specified, the units must also be included.

**Note:** Some filters allow the use of a wildcard when entering the command. The following rules apply to the use of wildcards with the SAN Volume Controller CLI:

- The wildcard character is an asterisk (\*).
- The command can contain a maximum of one wildcard, which must be the first or last character in the string.
- When using a wildcard character, you must enclose the filter entry within double quotation marks (""), as follows:

```
lsmdisk -filtervalue "name=md*"
```

#### **-filtervalue?**

(Optional) Includes all of the valid filter attributes in the report. The following filter attributes are valid for the **lsmdisk** command:

- id
- name
- status
- mode
- mdisk\_grp\_id
- mdisk\_grp\_name
- capacity
- quorum\_index
- block\_size
- controller\_name
- ctrl\_WWNN
- controller\_id
- path\_count
- ctrl\_LUN\_#
- UID
- preferred\_WWPN
- active\_WWPN
- tier

Any parameters specified with the **-filtervalue?** parameter are ignored.

#### **-nohdr**

(Optional) By default, headings are displayed for each column of data in a concise style view, and for each item of data in a detailed style view. The **-nohdr** parameter suppresses the display of these headings.

**Note:** If there is no data to be displayed, headings are not displayed.

#### **-bytes**

(Optional) Specifies that you want the report to display all capacities as bytes. Capacity values displayed in units other than bytes might be rounded. When filtering on capacity, use a unit of bytes, **-unit b**, for exact filtering.

#### **-delim delimiter**

(Optional) By default in a concise view, all columns of data are space separated. The width of each column is set to the maximum possible width of each item of data. In a detailed view, each item of data has its own row, and if the headers are displayed the data is separated from the header by a space. The **-delim** parameter overrides this behavior. Valid input for the **-delim** parameter is a one-byte character. If you enter **-delim :** on the command line, the colon character (:) separates all items of data in a concise view; for example, the spacing of columns does not occur. In a detailed view, the data is separated from its header by the specified delimiter.

*object\_id* | *object\_name*

(Optional) Specifies the name or ID of an object. When you use this parameter, the detailed view of the specific object is returned and any value that is specified by the **-filtervalue** parameter is ignored. If you do not specify the *object\_id* | *object\_name* parameter, the concise view displays all objects matching the filtering requirements that are specified by the **-filtervalue** parameter.

## Description

This command returns a concise list or a detailed view of MDisks visible to the cluster. Table 33 provides the potential output for MDisks.

Table 33. MDisk output

| Attribute            | Values                                                                                                                                                                                                                                                                                                                                                                                                                                                                                                         |
|----------------------|----------------------------------------------------------------------------------------------------------------------------------------------------------------------------------------------------------------------------------------------------------------------------------------------------------------------------------------------------------------------------------------------------------------------------------------------------------------------------------------------------------------|
| status               | <ul style="list-style-type: none"><li>• online</li><li>• offline</li><li>• excluded</li><li>• degraded_paths</li><li>• degraded_ports</li><li>• degraded (applies only to internal MDisks)</li></ul>                                                                                                                                                                                                                                                                                                           |
| mode                 | unmanaged, managed, image, array                                                                                                                                                                                                                                                                                                                                                                                                                                                                               |
| quorum_index         | 0, 1, 2, or blank if the MDisk is not being used as a quorum disk                                                                                                                                                                                                                                                                                                                                                                                                                                              |
| block_size           | 512, 524 bytes in each block of storage                                                                                                                                                                                                                                                                                                                                                                                                                                                                        |
| ctrl_type            | 4, 6, where 6 is a solid-state drive (SSD) attached inside a node and 4 is any other device                                                                                                                                                                                                                                                                                                                                                                                                                    |
| tier                 | The tier this MDisk has been assigned to by auto-detection (for internal arrays) or by the user: <ul style="list-style-type: none"><li>• generic_ssd</li><li>• generic_hdd (the default value for newly discovered or external MDisk)</li></ul> <b>Note:</b> You can change this value using the <code>chmdisk</code> command.                                                                                                                                                                                 |
| raid_status          | <ul style="list-style-type: none"><li>• offline - the array is offline on all nodes</li><li>• degraded - the array has deconfigured or offline members; the array is not fully redundant</li><li>• syncing - array members are all online, the array is syncing parity or mirrors to achieve redundancy</li><li>• initting - array members are all online, the array is initializing; the array is fully redundant</li><li>• online - array members are all online, and the array is fully redundant</li></ul> |
| raid_level           | The RAID level of the array (RAID0, RAID1, RAID5, RAID6, RAID10).                                                                                                                                                                                                                                                                                                                                                                                                                                              |
| redundancy           | The number of how many member disks can fail before the array fails.                                                                                                                                                                                                                                                                                                                                                                                                                                           |
| strip_size           | The strip size of the array (in KB).                                                                                                                                                                                                                                                                                                                                                                                                                                                                           |
| spare_goal           | The number of spares that the array members should be protected by.                                                                                                                                                                                                                                                                                                                                                                                                                                            |
| spare_protection_min | The minimum number of spares that an array member is protected by.                                                                                                                                                                                                                                                                                                                                                                                                                                             |
| balanced             | Describes if the array is balanced to its spare goals: <ul style="list-style-type: none"><li>• exact: all populated members have exact capability match, exact location match</li><li>• yes: all populated members have at least exact capability match, exact chain, or different enclosure or slot</li><li>• no: anything else</li></ul>                                                                                                                                                                     |



```
ctrl_type:4
ctrl_WWNN:200400A0B80F0702
controller_id:1
path_count:2
max_path_count:2
ctrl_LUN #:0000000000000000
UID:600a0b80000f07020000005c45ff8a7c000000000000000000000000000000
preferred_WWPN:200400A0B80F0703
active_WWPN:200400A0B80F0703
node_id:
node_name:
location:
fast_write_state:empty
raid_status:
raid_level:
redundancy:
strip_size:
spare_goal:
spare_protection_min:
balanced:
tier:generic_hdd
```

### A detailed invocation example

```
lsarray mdisk3
```

### The resulting output

```
mdisk_id:3
mdisk_name:mdisk3
status:online
mode:array
mdisk_grp_id:0
mdisk_grp_name:mdiskgrp0
capacity:68.4GB
quorum_index:
block_size:
controller_name:
ctrl_type:
ctrl_WWNN:
controller_id:
path_count:
max_path_count:
ctrl_LUN #:
UID:
preferred_WWPN:
active_WWPN:
node_id:
node_name:
location:
fast_write_state:empty
raid_status:online
raid_level:raid0
redundancy:0
strip_size:256
spare_goal:2
spare_protection_min:2
balanced:yes
tier:generic_ssd
```

---

## Ismdiskdumps (Deprecated)

**Attention:** The `svcinfolismdiskdumps` command is deprecated. Use the `svcinfolsdumps` command to display a list of files in a particular dumps directory.

---

## lsmdisklba

The **lsmdisklba** command lists the MDisk and logical block address (LBA) for the specified VDisk LBA.

### Syntax

```
lsmdisklba -vdisklba vdisklba [-copy id] [-delim delimiter]
[-nohdr] -vdisk vdisk_id vdisk_name
```

### Parameters

#### **-vdisklba** *vdisklba*

(Required) Specifies the 64-bit hexadecimal logical block address (LBA) on the VDisk. The LBA must be specified in hex, with a 0x prefix.

#### **-copy** *id*

(Optional) Specifies the VDisk copy ID to list the MDisk and LBA for. If this parameter is not specified, the command lists MDisks and LBAs for all VDisk copies.

#### **-nohdr**

(Optional) By default, headings are displayed for each column of data in a concise style view, and for each item of data in a detailed style view. The **-nohdr** parameter suppresses the display of these headings.

**Note:** If there is no data to be displayed, headings are not displayed.

#### **-delim** *delimiter*

(Optional) By default in a concise view, all columns of data are space separated. The width of each column is set to the maximum possible width of each item of data. In a detailed view, each item of data has its own row, and if the headers are displayed the data is separated from the header by a space. The **-delim** parameter overrides this behavior. Valid input for the **-delim** parameter is a one-byte character. If you enter **-delim :** on the command line, the colon character (:) separates all items of data in a concise view; for example, the spacing of columns does not occur. In a detailed view, the data is separated from its header by the specified delimiter.

*vdisk\_id* | *vdisk\_name*

(Required) Specifies the VDisk name or ID.

### Description

The **lsmdisklba** command returns the logical block address (LBA) of the MDisk that is associated with the VDisk LBA. For mirrored VDIs, the command lists the MDisk LBA for both the primary and the copy.

If applicable, the command also lists the range of LBAs on both the VDisk and MDisk that are mapped in the same extent, or for space-efficient disks, in the same grain. If a space-efficient VDisk is offline and the specified LBA is not allocated, the command displays the VDisk LBA range only.

Table 34 on page 247 summarizes the data that can be returned with this command.

Table 34. `lsmdisklba` command output

| Field                    | Fully allocated,<br>single copy VDisk | LBA not allocated on<br>space-efficient VDisk | Mirrored VDisk with one normal copy and<br>one offline space-efficient copy |                      |
|--------------------------|---------------------------------------|-----------------------------------------------|-----------------------------------------------------------------------------|----------------------|
|                          |                                       |                                               | Normal copy                                                                 | Space-efficient copy |
| <code>copy_id</code>     | yes                                   | yes                                           | yes                                                                         | yes                  |
| <code>mdisk_id</code>    | yes                                   | no                                            | yes                                                                         | no                   |
| <code>mdisk_name</code>  | yes                                   | no                                            | yes                                                                         | no                   |
| <code>type</code>        | allocated                             | unallocated                                   | allocated                                                                   | offline              |
| <code>mdisk_lba</code>   | yes                                   | no                                            | yes                                                                         | no                   |
| <code>mdisk_start</code> | yes                                   | no                                            | yes                                                                         | no                   |
| <code>mdisk_end</code>   | yes                                   | no                                            | yes                                                                         | no                   |
| <code>vdisk_start</code> | yes                                   | yes                                           | yes                                                                         | yes                  |
| <code>vdisk_end</code>   | yes                                   | yes                                           | yes                                                                         | yes                  |

### An invocation example

```
lsmdisklba -vdisk 0 -vdisklba 0x0
```

### The resulting output

```
copy_id 0
mdisk_id 1
mdisk_name mdisk1
type allocated
mdisk_lba 0x00090000
mdisk_start 0x00090000
mdisk_end 0x000907FF
vdisk_start 0x00000000
vdisk_end 0x000007FF
```

---

## lsmdiskcandidate

The `lsmdiskcandidate` command lists all of the unmanaged MDiskS by MDisk ID.

### Syntax

```

▶▶ lsmdiskcandidate — [-nohdr] — [-delim — delimiter]

```

### Parameters

#### **-nohdr**

(Optional) By default, headings are displayed for each column of data in a concise style view, and for each item of data in a detailed style view. The **-nohdr** parameter suppresses the display of these headings.

**Note:** If there is no data to be displayed, headings are not displayed.

#### **-delim *delimiter***

(Optional) By default in a concise view, all columns of data are space-separated. The width of each column is set to the maximum possible width of each item of data. In a detailed view, each item of data has its own row, and if the headers are displayed, the data is separated from the header by a space. The **-delim** parameter overrides this behavior. Valid input for the **-delim** parameter is a one-byte character. If you enter `-delim :` on the command line, the colon character (:) separates all

items of data in a concise view; for example, the spacing of columns does not occur. In a detailed view, the data is separated from its header by the specified delimiter.

## Description

This command displays a list of MDisks that are unmanaged. Only the MDisk IDs are displayed.

When back-end controllers are added to the Fibre Channel SAN and are included in the same switch zone as a cluster, the cluster automatically detects the back-end controller to determine which storage is presented to the node. The SCSI logical units that are presented by the back-end controller are displayed as unmanaged MDisks. However, if the configuration of the back-end controller is modified after this has occurred, the cluster might be unaware of these configuration changes. You can then request that the cluster rescan the Fibre Channel SAN to update the list of unmanaged MDisks.

**Note:** The automatic detection performed by the cluster does not write anything to a unmanaged MDisk. It is only when you instruct the cluster to add an MDisk to a managed disk group or use a MDisk to create an image mode virtual disk that the storage is actually used.

Check to see which MDisks are available by issuing the **detectmdisk** command to manually scan the Fibre Channel network for any MDisks. Issue the **lsmdiskcandidate** command to show the unmanaged MDisks. These MDisks have not been assigned to an MDisk group. Alternatively, you can issue the **lsmdisk** command to view all of the MDisks.

### An invocation example

```
lsmdiskcandidate
```

### The resulting output

```
id
5
6
7
8
9
10
11
12
13
14
```

---

## lsmdiskextent

The **lsmdiskextent** command displays the extent allocation between managed disks and virtual disks. The output lists a VDisk ID, VDisk copy ID, and the number of extents.

## Syntax

```
▶▶ lsmdiskextent - [-nohdr] [-delim delimiter] [mdisk_name / mdisk_id] ▶▶
```

## Parameters

### -nohdr

(Optional) By default, headings are displayed for each column of data in a concise style view, and for each item of data in a detailed style view. The **-nohdr** parameter suppresses the display of these headings.

**Note:** If there is no data to be displayed, headings are not displayed.



### **-delim** *delimiter*

(Optional) By default in a concise view, all columns of data are space-separated. The width of each column is set to the maximum possible width of each item of data. In a detailed view, each item of data has its own row, and if the headers are displayed, the data is separated from the header by a space. The **-delim** parameter overrides this behavior. Valid input for the **-delim** parameter is a one-byte character. If you enter `-delim :` on the command line, the colon character (`:`) separates all items of data in a concise view; for example, the spacing of columns does not occur. In a detailed view, the data is separated from its header by the specified delimiter.

*mdisk\_name* | *mdisk\_id*

(Required) Specifies the specific object ID or name of the given type.

## **Description**

The command displays a list, in which each entry contains a VDisk ID, VDisk copy ID, and the number of extents. These VDisk copies are using extents on the specified MDisk. The number of extents being used on each MDisk is also shown.

Every VDisk copy is constructed from one or more MDisks. At times, you might have to determine the relationship between the two objects. The following procedure allows you to determine the relationships.

To determine the relationship between VDisk copies and MDisks, issue the following command for each VDisk copy:

```
lsvdiskmember vdisk_name | vdisk_id
```

where *vdisk\_name* | *vdisk\_id* is the name or ID of the VDisk copy. This displays a list of IDs that correspond to the MDisks that make up the VDisk copy.

To determine the relationship between VDisk copies and MDisks and the number of extents that are provided by each MDisk, you must use the command-line interface. For each VDisk copy, issue the following command:

```
lsvdiskextent vdisk_name | vdisk_id
```

where *vdisk\_name* | *vdisk\_id* is the name or ID of the VDisk copy. This displays a table of MDisk IDs and the corresponding number of extents that each MDisk is providing as storage for the given VDisk copy.

To determine the relationship between MDisks and VDisk copies, issue the following command for each MDisk:

```
lsmdiskmember mdisk_name | mdisk_id
```

where *mdisk\_name* | *mdisk\_id* is the name or ID of the MDisk. This displays a list of IDs that correspond to the VDisk copies that are using this MDisk.

To determine the relationship between MDisks and VDisk copies and the number of extents that are used by each VDisk copy, you must use the command-line interface. For each MDisk, issue the following command:

```
lsmdiskextent mdisk_name | mdisk_id
```

where *mdisk\_name* | *mdisk\_id* is the name or ID of the MDisk. This command displays a table of VDisk copy IDs and the corresponding number of extents that are being used by each VDisk copy.

## **An invocation example**

```
lsmdiskextent -delim : mdisk0
```

## The resulting output

```
id:number_of_extents:copy_id
1:1:1
```

---

## lsmdiskgrp

The **lsmdiskgrp** command returns a concise list or a detailed view of MDisk groups (storage pools) that are visible to the cluster.

## Syntax

```
lsmdiskgrp [-filtervalue attrib=value] [-nohdr] [-bytes]
[-delim delimiter] [-filtervalue?] [object_id | object_name]
```

## Parameters

### **-filtervalue** *attrib=value*

(Optional) Specifies a list of one or more filters. Only objects with a value that matches the filter attribute value are returned. If a capacity is specified, the units must also be included.

**Note:** Some filters allow the use of a wildcard when you enter the command. The following rules apply to the use of wildcards with the SAN Volume Controller CLI:

- The wildcard character is an asterisk (\*).
- The command can contain a maximum of one wildcard, which must be the first or last character in the string.
- When using a wildcard, you must enclose the filter entry within double quotation marks (""), as follows:

```
lsmdiskgrp -filtervalue "name=md*"
```

### **-nohdr**

(Optional) By default, headings are displayed for each column of data in a concise style view, and for each item of data in a detailed style view. The **-nohdr** parameter suppresses the display of these headings.

**Note:** If there is no data to be displayed, headings are not displayed.

### **-bytes**

(Optional) Specifies that you want the report to display all capacities as bytes.

### **-delim** *delimiter*

(Optional) By default in a concise view, all columns of data are space-separated. The width of each column is set to the maximum possible width of each item of data. In a detailed view, each item of data has its own row, and if the headers are displayed the data is separated from the header by a space. The **-delim** parameter overrides this behavior. Valid input for the **-delim** parameter is a one byte character. If you enter `-delim :` on the command line, the colon character (:) separates all items of data in a concise view; for example, the spacing of columns does not occur. In a detailed view, the data is separated from its header by the specified delimiter.

### *object\_id* | *object\_name*

(Optional) Specifies the name or ID of an object. When you use this parameter, the detailed view of the specific object is returned and any value specified by the **-filtervalue** parameter is ignored. If you

do not specify the *object\_id* | *object\_name* parameter, the concise view of all objects matching the filtering requirements specified by the **-filtervalue** parameter are displayed.

#### **-filtervalue?**

Displays a list of valid filter attributes. The valid filters for the **lsmdiskgrp** command are:

- name
- storage\_pool\_id
- mdisk\_count
- vdisk\_count
- extent\_size
- status
- id
- easy\_tier
- easy\_tier\_status

## **Description**

This command returns a concise list or a detailed view of MDisk groups visible to the cluster.

Command output includes values for the following attributes:

**status** The state of the MDisk with the highest-priority status in the group, excluding image mode MDisks.

#### **VDisk\_count**

The number of VDisk (volume) copies that are in the MDisk group (storage pool).

#### **capacity**

The total amount of MDisk storage that is assigned to the MDisk group.

#### **extent\_size**

The size of the extents for this group: 16, 32, 64, 128, 256, 512, 1024, 2048, 4096, or 8192 (MB).

#### **free\_capacity**

The amount of MDisk storage that is assigned to the MDisk group that is unused. MDisk storage can be used for cluster quorum data and VDIs.

#### **real\_capacity**

The amount of MDisk storage that is assigned to the MDisk group that is assigned to VDIs.

#### **virtual\_capacity**

The total virtual size of all the VDisk copies that are associated with the MDisk group. This is the same as the *real\_capacity* value unless you have configured space-efficient VDisk copies in this MDisk group.

#### **used\_capacity**

The total used size of all the VDisk copies that are associated with the MDisk group. This is the same as the *real\_capacity* value unless you have configured space-efficient VDisk copies in this MDisk group.

#### **overalllocation**

Expressed as a percentage, the ratio of the *virtual\_capacity* value to the *capacity*. An MDisk group overalllocation of over 100 is only possible if you have configured space-efficient VDisk copies.

#### **warning**

This field is a percentage. A warning is generated when the amount of space in the MDisk group that has been assigned exceeds this level.

#### **easy\_tier**

This value is set by the user and determines whether Easy Tier is permitted to manage the pool.

**Note:**

1. If `easy_tier` is *on*, then `easy_tier_status` is *active*
2. If `easy_tier` is *off*, then `easy_tier_status` is *inactive*
3. If `easy_tier` is *auto*, then the value of `easy_tier_status` is determined by the number of tiers an MDisk group has.

**easy\_tier\_status**

Whether the Easy Tier functions are active on an MDisk group:

- active
- inactive

**tier** Which tier information is being reported:

- generic\_ssd
- generic\_hdd

**tier\_mdisk\_count**

The number of MDisks in the tier.

**tier\_capacity**

The total MDisk capacity assigned to the VDisk in the tier.

**Note:** For space-efficient copies, the capacity by tier will be the real capacity.

**tier\_free\_capacity**

The unused amount of MDisk storage in the tier.

The following define the status fields, from lowest to highest priority:

**Online**

The MDisk group is online and available.

**Offline**

All paths to the MDisk group are lost.

**A concise invocation example**

```
lsmdiskgrp -delim :
```

**The concise resulting output**

```
id:name:status:mdisk_count:vdisk_count:capacity:extent_size:free_capacity:
virtual_capacity:used_capacity:real_capacity:overallocation:warning:easy_tier:easy_tier_status
0:mdiskgrp0:degraded:4:0:34.2GB:16:34.2GB:0:0:0:0:0:auto:inactive
1:mdiskgrp1:online:4:6:200GB:16:100GB:400GB:75GB:100GB:200:80:on:active
```

**An detailed invocation example for an MDisk group with one tier**

```
lsmdiskgrp -delim : mdiskgrp1
```

**The resulting output**

```
id:1
name:mdiskgrp1
status:online
mdisk_count:4
vdisk_count:6
capacity:200GB
extent_size:16
free_capacity:100GB
virtual_capacity:400.00GB
used_capacity:75.00GB
real_capacity:100.00GB
overallocation:200
warning:80
```

```

easy_tier:on
easy_tier_status:active
tier:generic_ssd
tier_mdisk_count:0
tier_capacity: 0.00MB
tier_free_capacity: 0.00MB
tier:generic_hdd
tier_mdisk_count:4
tier_capacity:200.00GB
tier_free_capacity:100.00GB

```

### An detailed invocation example for an MDisk group with two tiers

```
lsmdiskgrp -delim : mdiskgrp2
```

### The resulting output

```

id:2
name:mdiskgrp2
status:online
mdisk_count:8
vdisk_count:6
capacity:200GB
extent_size:16
free_capacity:100GB
virtual_capacity:400.00GB
used_capacity:75.00GB
real_capacity:100.00GB
overallocation:200
warning:80
easy_tier:auto
easy_tier_status:active
tier:generic_ssd
tier_mdisk_count:2
tier_capacity:20.00GB
tier_free_capacity: 0.00MB
tier:generic_hdd
tier_mdisk_count:6
tier_capacity:180.00GB
tier_free_capacity:100.00GB

```

---

## lsmdiskmember

The **lsmdiskmember** command displays a list of VDIsks that are using extents on the specified MDisk. That is, the virtual disks are using extents on the managed disk that are specified by the MDisk ID.

### Syntax

```

▶▶ lsmdiskmember — [-nohdr] [-delim delimiter] [mdisk_id / mdisk_name] ▶▶

```

### Parameters

#### -nohdr

(Optional) By default, headings are displayed for each column of data in a concise style view, and for each item of data in a detailed style view. The **-nohdr** parameter suppresses the display of these headings.

**Note:** If there is no data to be displayed, headings are not displayed.

#### -delim *delimiter*

(Optional) By default in a concise view, all columns of data are space-separated. The width of each column is set to the maximum possible width of each item of data. In a detailed view, each item of

data has its own row, and if the headers are displayed, the data is separated from the header by a space. The **-delim** parameter overrides this behavior. Valid input for the **-delim** parameter is a one-byte character. If you enter `-delim :` on the command line, the colon character (`:`) separates all items of data in a concise view; for example, the spacing of columns does not occur. In a detailed view, the data is separated from its header by the specified delimiter.

*mdisk\_id | mdisk\_name*

(Required) Specifies the ID or name of the MDisk for which you want a list of VDIsks that use extents of that MDisk.

## Description

This command displays a list of virtual disks that use extents on the managed disk that are specified by the ID. The list displays members of the respective object and is independent of the state of the individual members; that is, if they are in offline state, they are still displayed.

Every VDisk is constructed from one or more MDisks. To determine the relationship between VDisk copies and MDisks, issue the following command:

```
lsvdiskmember vdisk_id | vdisk_name
```

where *vdisk\_id | vdisk\_name* is the name or ID of the VDisk copy. This displays a list of IDs that correspond to the MDisks that make up the VDisk copy.

To determine the relationship between VDisk copies and MDisks and the number of extents that are provided by each MDisk, you must use the command-line interface. For each VDisk copy, issue the following command:

```
lsvdiskextent vdisk_id | vdisk_name
```

where *vdisk\_id | vdisk\_name* is the name or ID of the VDisk copy. This command displays a table of MDisk IDs and the corresponding number of extents that each MDisk provides as storage for the VDisk copy.

To determine the relationship between MDisks and VDisk copies, issue the following command:

```
lsmdiskmember mdisk_id | mdisk_name
```

where *mdisk\_id | mdisk\_name* is the name or ID of the MDisk. This command displays a list of IDs that correspond to the VDisk copies that are using this MDisk.

To determine the relationship between MDisks and VDisk copies and the number of extents that are used by each VDisk copy, you must use the command-line interface. For each MDisk *mdisk\_id | mdisk\_name*, issue the following command:

```
lsmdiskextent mdisk_id | mdisk_name
```

where *mdisk\_id | mdisk\_name* is the name or ID of the MDisk. This command displays a table of VDisk copy IDs and the corresponding number of extents that are being used by each VDisk copy.

## An invocation example

```
lsmdiskmember -delim : 1
```

## The resulting output

```
id:copy_id
0:0
1:0
2:0
3:0
4:0
5:0
6:0
```

---

## lsmigrate

The `lsmigrate` command displays the progress of all current data migration operations.

### Syntax

```
lsmigrate [-nohdr] [-delim delimiter]
```

### Parameters

#### **-nohdr**

(Optional) By default, headings are displayed for each column of data in a concise style view, and for each item of data in a detailed style view. The **-nohdr** parameter suppresses the display of these headings.

**Note:** If there is no data to be displayed, headings are not displayed.

#### **-delim *delimiter***

(Optional) By default in a concise view, all columns of data are space-separated. The width of each column is set to the maximum possible width of each item of data. In a detailed view, each item of data has its own row, and if the headers are displayed, the data is separated from the header by a space. The **-delim** parameter overrides this behavior. Valid input for the **-delim** parameter is a one-byte character. If you enter `-delim :` on the command line, the colon character (`:`) separates all items of data in a concise view; for example, the spacing of columns does not occur. In a detailed view, the data is separated from its header by the specified delimiter.

If you use multiple threads to migrate data, the progress will increment when all threads have completed the migration of an extent. For large extent sizes with many threads, this can result in quite large increments in the percentage progress.

### Description

This command displays information of all the migrations that are currently in progress.

**Note:** Only user-initiated migrations that are reported using this command. Easy Tier migrations are not included in the output.

#### An invocation example

```
lsmigrate -delim :
```

#### The resulting output

```
migrate_type:MDisk_Group_Migration
progress:96
migrate_source_vdisk_index:33
migrate_target_mdisk_grp:4
max_thread_count:4
migrate_source_vdisk_copy_id:1
```

---

## Isnode

The **Isnode** command returns a concise list or a detailed view of nodes that are part of the cluster.

The list report style can be used to obtain two styles of report:

- A list containing concise information about all the nodes on a cluster. (Each entry in the list corresponds to a single node.)
- The detailed information about a single node.

## Syntax

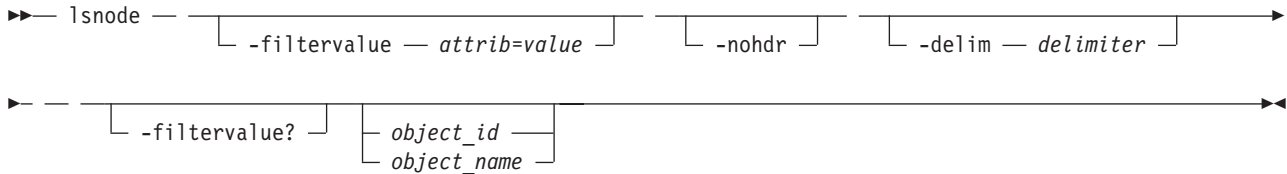

## Parameters

### **-filtervalue** *attrib=value*

(Optional) Specifies a list of one or more filters. Only objects with a value that matches the filter attribute value are returned. If a capacity is specified, the units must also be included.

**Note:** Some filters allow the use of a wildcard when you enter the command. The following rules apply to the use of wildcards with the SAN Volume Controller CLI:

- The wildcard character is an asterisk (\*).
- The command can contain a maximum of one wildcard.
- When using a wildcard, you must enclose the filter entry within double quotation marks (""), as follows:

```
Isnode -filtervalue "name=md*"
```

### **-filtervalue?**

Displays a list of valid filter attributes for the **-filtervalue** *attribute=value* parameter. The valid filters for the **Isnode** command are:

- id
- status
- IO\_group\_name
- IO\_group\_id
- name
- hardware
- service\_IP\_address
- UPS\_serial\_number
- WWNN
- partner\_node\_id
- partner\_node\_name
- config\_node
- UPS\_unique\_id
- iscsi\_alias
- panel\_name
- enclosure\_id



- canister\_id
- enclosure\_serial\_number

**-nohdr**

(Optional) By default, headings are displayed for each column of data in a concise style view, and for each item of data in a detailed style view. The **-nohdr** parameter suppresses the display of these headings.

**Note:** If there is no data to be displayed, headings are not displayed.

**-delim delimiter**

(Optional) By default in a concise view, all columns of data are space-separated. The width of each column is set to the maximum possible width of each item of data. In a detailed view, each item of data has its own row, and if the headers are displayed the data is separated from the header by a space. The **-delim** parameter overrides this behavior. Valid input for the **-delim** parameter is a one-byte character. If you enter **-delim :** on the command line, the colon character (:) separates all items of data in a concise view; for example, the spacing of columns does not occur. In a detailed view, the data is separated from its header by the specified delimiter.

**object\_id | object\_name**

(Optional) Specifies the name or ID of an object. When you use this parameter, the detailed view of the specific object is returned and any value that is specified by the **-filtervalue** parameter is ignored. If you do not specify the **object\_id | object\_name** parameter, the concise view of all objects matching the filtering requirements that is specified by the **-filtervalue** parameter are displayed.

## Description

**SAN Volume Controller:** This command returns a concise list or a detailed view of nodes that are part of the cluster. Table 35 provides the possible values that are applicable to the attributes that are displayed as data in the output views.

Table 35. Isnode attribute values

| Attribute               | Value                                                     |
|-------------------------|-----------------------------------------------------------|
| status                  | offline   flushing   pending   online   adding   deleting |
| config_node             | no   yes                                                  |
| port_status             | active   inactive   not installed                         |
| hardware                | 8F2   8F4   8G4   CF8   CG8   8A4   other                 |
| UPS_serial_number       | The serial number of the UPS.                             |
| status                  | The status of the node.                                   |
| UPS_unique_id           | The unique ID of the UPS.                                 |
| panel_name              | Unique identifier for the nodes.                          |
| enclosure_id            | Blank.                                                    |
| canister_id             | Blank.                                                    |
| enclosure_serial_number | Blank.                                                    |

**Storwize® V7000:** This command returns a concise list or a detailed view of nodes that are part of the cluster. Table 36 provides the possible values that are applicable to the attributes that are displayed as data in the output views.

Table 36. Isnode attribute values

| Attribute | Value                                                     |
|-----------|-----------------------------------------------------------|
| status    | offline   flushing   pending   online   adding   deleting |

Table 36. Isnode attribute values (continued)

| Attribute               | Value                                                                |
|-------------------------|----------------------------------------------------------------------|
| config_node             | no   yes                                                             |
| port_status             | active   inactive   not installed                                    |
| hardware                | 100   300                                                            |
| UPS_serial_number       | Blank.                                                               |
| status                  | The status of the node.                                              |
| UPS_unique_id           | Blank.                                                               |
| panel_name              | A compound of enclosure ID and canister ID, separated with a hyphen. |
| enclosure_id            | The enclosure that the node is in, shown on the front panel.         |
| canister_id             | The canister that the node is in.                                    |
| enclosure_serial_number | The serial number of the enclosure.                                  |

### A concise invocation example

```
lsnode -delim
```

### The resulting SAN Volume Controller output:

```
IBM_2145:ldcluster-19:admin>lsnode -delim ,
id,name,UPS_serial_number,WWNN,status,IO_group_id,IO_group_name,config_node,UPS_unique_id,hardware,
iscsi_name,
iscsi_alias,panel_name,enclosure_id,canister_id,enclosure_serial_number1,hlcn114289,
10004BC018,5005076801002978,
online,0,io_grp0,no,20400001124C0048,8A4,iqn.1986-03.com.ibm:2145.ldcluster-19.hlcn114289,,
114289,,,
2,hlcn114253,10004BC023,5005076801002822,online,0,io_grp0,yes,20400001124C0083,8A4,
iqn.1986-03.com.ibm:2145.ldcluster-19.hlcn114253,,114253,,,5,hdn116511,1000871087,
5005076801005CCE,online,
1,io_grp1,no,2040000207040207,CF8,iqn.1986-03.com.ibm:2145.ldcluster-19.hdn116511,,116511,,,
4,hdn116520,100062L106,5005076801005FD0,online,1,io_grp1,no,2040000182701006,CF8,
iqn.1986-03.com.ibm:2145.ldcluster-19.hdn116520,,116520,,,
```

### The resulting Storwize V7000 output:

```
id,name,UPS_serial_number,WWNN,status,IO_group_id,IO_group_name,config_node,UPS_unique_id,hardware,
iscsi_name,iscsi_alias,
panel_name,enclosure_id,canister_id,enclosure_serial_number1,node1,,50050768010010FE,online,0,
io_grp0,yes,
50050768010010FE,100,iqn.1986-03.com.ibm:2145.tbcluster-12.node1,,01-1,1,1,00001A2
2,node2,,5005076801000FFE,online,0,io_grp0,no,5005076801000FFE,100,iqn.1986-03.com.ibm:
2145.tbcluster-12.node2,,
01-2,1,2,00001A2
```

### A detailed invocation example

```
lsnode -delim , 1
```

```
lsnode 1
```

### The resulting SAN Volume Controller output

```
id,1
name,hlcn114289
UPS_serial_number,10004BC018
WWNN,5005076801002978
status,online
IO_group_id,0
IO_group_name,io_grp0
partner_node_id,2
```

```

partner_node_name,hlcn114253
config_node,no
UPS_unique_id,20400001124C0048
port_id,5005076801402978
port_status,active
port_speed,4Gb
port_id,5005076801302978
port_status,active
port_speed,4Gb
port_id,5005076801102978
port_status,active
port_speed,4Gb
port_id,5005076801202978
port_status,active
port_speed,4Gb
hardware,8A4
iscsi_name,iqn.1986-03.com.ibm:2145.lcluster-19.hlcn114289
iscsi_alias,
failover_active,no
failover_name,hlcn114253
failover_iscsi_name,iqn.1986-03.com.ibm:2145.lcluster-19.hlcn114253
failover_iscsi_alias,
panel_name,114289
enclosure_id,
canister_id,
enclosure_serial_number,
service_IP_address,9.180.29.52
service_gateway,9.180.28.1
service_subnet_mask,255.255.254.0
service_IP_address_6,
service_gateway_6,
service_prefix_6,

```

### The Storwize V7000 resulting output:

```

id 1
name node1
UPS_serial_number
WWNN 50050768010010FE
status online
IO_group_id 0
IO_group_name io_grp0
partner_node_id 2
partner_node_name node2
config_node yes
UPS_unique_id 50050768010010FE
port_id 50050768011010FE
port_status active
port_speed 4Gb
port_id 50050768012010FE
port_status active
port_speed 4Gb
port_id 50050768013010FE
port_status active
port_speed 4Gb
port_id 50050768014010FE
port_status active
port_speed 4Gb
hardware 100
iscsi_name iqn.1986-03.com.ibm:2145.tbcluster-12.node1
iscsi_alias
failover_active no
failover_name node2
failover_iscsi_name iqn.1986-03.com.ibm:2145.tbcluster-12.node2
failover_iscsi_alias
panel_name 01-1
enclosure_id 1

```

```

canister_id 1
enclosure_serial_number 00001A2
service_IP_address 192.168.70.121
service_gateway 102.68.70.1
service_subnet_mask 255.255.255.0
service_IP_address_6
service_gateway_6
service_prefix_6

```

## lsnodehw

The **lsnodehw** command enables you to view the configured and actual hardware configuration of nodes in the clustered system.

### Syntax

```

▶▶ lsnodehw [-delim delimiter] node_id_or_name

```

### Parameters

#### **-delim** *delimiter*

(Optional) By default in a concise view, all columns of data are space-separated. The width of each column is set to the maximum possible width of each item of data. In a detailed view, each item of data has its own row, and if the headers are displayed the data is separated from the header by a space. The **-delim** parameter overrides this behavior. Valid input for the **-delim** parameter is a one-byte character. If you enter **-delim :** on the command line, the colon character (:) separates all items of data in a concise view; for example, the spacing of columns does not occur. In a detailed view, the data is separated from its header by the specified delimiter.

#### **lsnodehw** *node\_id\_or\_name*

Indicates the node ID or node name.

### Description

Table 37 provides the possible values that are applicable to the attributes that are displayed as data in the output views.

Table 37. *lsnodehw* attribute values

| Attribute         | Value                                                                     |
|-------------------|---------------------------------------------------------------------------|
| id                | The node unique ID.                                                       |
| name              | The node name.                                                            |
| status            | The node status.                                                          |
| IO_group_id       | The I/O group ID.                                                         |
| IO_group_name     | The I/O group name.                                                       |
| hardware          | The hardware model.                                                       |
| actual_different  | Indicates if the node hardware is different from the configured hardware. |
| actual_valid      | Indicates if the node hardware is valid.                                  |
| memory_configured | The configured amount of memory (in GB).                                  |
| member_actual     | The currently installed amount of memory (in GB).                         |
| memory_valid      | Indicates if the actual memory is a valid configuration.                  |
| cpu_count         | The maximum number of CPUs for the node.                                  |

Table 37. *lsnodehw* attribute values (continued)

| Attribute          | Value                                                               |
|--------------------|---------------------------------------------------------------------|
| cpu_socket         | The ID of socket the CPU fields refer to.                           |
| cpu_actual         | The configured CPU for this socket.                                 |
| cpu_valid          | The currently installed CPU in this socket.                         |
| adapter_count      | Indicates if the currently installed CPU is a valid configuration.  |
| adapter_location   | The maximum number of adapters for the node (differs by node type). |
| adapter_configured | The location of this adapter.                                       |
| adapter_actual     | The configured adapter for this location.                           |
| adapter_valid      | Indicates if the adapter in this location is valid.                 |

### An invocation example

```
svcinfolsnodehw -delim , 1
```

### The resulting output

```
id,1
name,h1cn114289
status,online
IO_group_id,0
IO_group_name,io_grp0
hardware,8A4
actual_different,yes
actual_valid,no
memory_configured,8
memory_actual,8
memory_valid,yes
cpu_count 2
cpu_socket 1
cpu_configured,4 core Intel(R) Xeon(R) CPU E3110 @ 3.0GHz
cpu_actual,4 core Intel(R) Xeon(R) CPU E3110 @ 3.0GHz
cpu_valid,yes
cpu_socket 2
cpu_configured,none
cpu_actual,none
cpu_valid,yes
adapter_count,4
adapter_location,0
adapter_configured,1Gb/s Ethernet adapter
adapter_actual,1Gb/s Ethernet adapter
adapter_valid,yes
adapter_location,0
adapter_configured,1Gb/s Ethernet adapter
adapter_actual,1Gb/s Ethernet adapter
adapter_valid,yes
adapter_location,1
adapter_configured,Four port 8Gb/s FC adapter card
adapter_actual,Four port 8Gb/s FC adapter card
adapter_valid,yes
adapter_location,2
adapter_configured,none
adapter_actual,Four port 8Gb/s FC adapter card
adapter_valid,no
```

---

## lsnodecandidate

The **lsnodecandidate** command lists all of the nodes that are available to add to the clustered system.

## Syntax

►► `lsnodecandidate` — `-nohdr` — `-delim delimiter` — `-svconfig` ►►

## Parameters

### **-nohdr**

(Optional) By default, headings are displayed for each column of data in a concise style view, and for each item of data in a detailed style view. The **-nohdr** parameter suppresses the display of these headings.

**Note:** If there is no data to be displayed, headings are not displayed.

### **-delim *delimiter***

(Optional) By default in a concise view, all columns of data are space-separated. The width of each column is set to the maximum possible width of each item of data. In a detailed view, each item of data has its own row, and if the headers are displayed, the data is separated from the header by a space. The **-delim** parameter overrides this behavior. Valid input for the **-delim** parameter is a one-byte character. If you enter `-delim :` on the command line, the colon character (`:`) separates all items of data in a concise view; for example, the spacing of columns does not occur. In a detailed view, the data is separated from its header by the specified delimiter.

### **-svconfig**

(Optional) Lists all nodes in the enclosure that are in a candidate state.

## Description

**Note:** The **lsnodecandidate** command is a SAN Volume Controller command. For Storwize V7000, use the **lscontrolenclosurecandidate** command.

This command displays a list of nodes that are available to add to the clustered system. This includes nodes that are not already part of a clustered system, but are compatible with the clustered system software level. Nodes with hardware types that are incompatible with the installed software are not listed.

The following table describes the possible outputs:

Table 38. *lsnodecandidate* outputs

| Attribute         | Description                                                                                                                                                              |
|-------------------|--------------------------------------------------------------------------------------------------------------------------------------------------------------------------|
| panel_name        | <b>SAN Volume Controller:</b> Unique identifier for the nodes.<br><b>Storwize V7000:</b> A compound of enclosure serial number and canister ID, separated with a hyphen. |
| UPS_serial_number | <b>SAN Volume Controller:</b> The serial number of the UPS.<br><b>Storwize V7000:</b> Can be blank.                                                                      |
| UPS_unique_id     | <b>SAN Volume Controller:</b> The unique ID of UPS.<br><b>Storwize V7000:</b> Can be blank.                                                                              |
| hardware          | Describes the type of node.                                                                                                                                              |

Table 39. *lsnodecandidate* outputs

| Attribute  | Description                        |
|------------|------------------------------------|
| panel_name | A unique identifier for the nodes. |

Table 39. *Isnodecandidate* outputs (continued)

| Attribute         | Description                 |
|-------------------|-----------------------------|
| UPS_serial_number | The serial number of UPS.   |
| UPS_unique_id     | The unique ID of UPS.       |
| hardware          | Describes the type of node. |

### An invocation example

```
lsnodecandidate -delim :
```

### The resulting output

```
id: panel_name: UPS_serial_number: UPS_unique_id: hardware
1: 146355: 10L3ASH: 202378101C0D18D8: 8G4
```

---

## Isnodedependentvdisks (Deprecated)

This command has been deprecated. Use the **lsdependentvdisks** command instead.

---

## Isnodestats

The **Isnodestats** command displays the most recent values of all node statistics, and displays all node statistics for a particular node.

### Syntax

```
lsnodestats [node_id | node_name] -delim delimiter
```

### Parameters

**lsnodestats** *node\_id* | *node\_name*  
 Identifies the node that you want to request statistics for.

**-delim** *delimiter*  
 (Optional) By default in a concise view, all columns of data are space-separated. The width of each column is set to the maximum possible width of each item of data. In a detailed view, each item of data has its own row, and if the headers are displayed, the data is separated from the header by a space. The **-delim** parameter overrides this behavior. Valid input for the **-delim** parameter is a one-byte character. If you enter `-delim :` on the command line, the colon character (:) separates all items of data in a concise view; for example, the spacing of columns does not occur. In a detailed view, the data is separated from its header by the specified delimiter.

### Description

This command returns a concise list or a detailed view of nodes that are part of the cluster. Table 40 provides the possible values that are applicable to the attributes that are displayed as data in the output views.

Table 40. *Isnodestats* attribute values

| Attribute | Value                 |
|-----------|-----------------------|
| node_id   | The ID of the node.   |
| node_name | The name of the node. |

| Table 40. *lsnodestats* attribute values (continued)

| Attribute      | Value                                                           |
|----------------|-----------------------------------------------------------------|
| stat_name      | The name of the statistic field.                                |
| stat_current   | The current value of the statistic field.                       |
| stat_peak      | The peak value of the statistic field in the last five minutes. |
| stat_peak_time | The time that the peak occurred.                                |

| **A concise invocation example**

| `lsnodestats`

| **The concise resulting output**

```
| node_id node_name stat_name stat_current stat_peak stat_peak_time
| 1 node1 cpu_pc 22 25 110101120100
| 1 node1 fc_mb 800 1000 110101120105
| 2 node2 cpu_pc 44 44 110101120120
| 2 node2 fc_mb 22 97 110101120120
```

| **A detailed invocation example**

| `svcinfo lsnodestats node1`

| **The detailed invocation output**

```
| node_id node_name stat_name stat_current stat_peak stat_peak_time
| 1 node1 cpu_pc 22 25 110101120100
| 1 node1 fc_mb 800 1000 110101120105
```

---

## lsnodevpd

The `lsnodevpd` command displays the vital product data (VPD) for each node.

### Syntax

```
▶▶ lsnodevpd [-nohdr] [-delim delimiter] [node_id | node_name] ▶▶
```

### Parameters

**-nohdr**

(Optional) By default, headings are displayed for each column of data in a concise style view, and for each item of data in a detailed style view. The **-nohdr** parameter suppresses the display of these headings.

**Note:** If there is no data to be displayed, headings are not displayed.

**-delim delimiter**

(Optional) By default in a concise view, all columns of data are space-separated. The width of each column is set to the maximum possible width of each item of data. In a detailed view, each item of data has its own row, and if the headers are displayed, the data is separated from the header by a space. Using the **-delim** parameter overrides this behavior. Valid input for the **-delim** parameter is a one-byte character. If you enter `-delim :` on the command line, the colon character (`:`) separates all items of data in a concise view; for example, the spacing of columns does not occur. In a detailed view, the data is separated from its header by the specified delimiter.

`node_id` | `node_name`

(Required) Specifies the node by its ID or name.



## Description

This command displays the VPD for the specified node. Each field is reported on a new line. All fields are strings. The VPD is split into sections. Each section has a section heading. The number of fields in that section follows each heading. Each section is separated by an empty line.

For example:

```
section name:3 fields
field1:value
field2:value
field3:value
```

```
new section:x fields
...
```

Some sections contain information about multiple objects of that type. Each object within the section is separated by an empty line.

For example:

```
section name:4 fields
object1 field1:value
object1 field2:value
```

```
object2 field1:value
object2 field2:value
```

```
new section: x fields
...
```

**Note:** For 8F4, 8G4, and 8A4 nodes, the VPD displays the device serial number of the Fibre Channel card as N/A.

## An invocation example

```
lshnodevpd 1
```

## The resulting output

```
id 1

system board: 21 fields
part_number 43V7072
system_serial_number KD1438A
number_of_processors 4
number_of_memory_modules 6
number_of_fans 6
number_of_FC_cards 1
number_of_scsi/ide_devices 2
BIOS_manufacturer IBM Corp.
BIOS_version -[D6E124AUS-1.01]-
BIOS_release_date 04/30/2009
system_manufacturer IBM
system_product IBM System x -[2145CF8]-
version 00
planar_manufacturer IBM
planar_product 49Y6498
planar_version (none)
power_supply_part_number 39Y7201
CMOS_battery_part_number 33F8354
```

frame\_assembly\_part\_number  
ethernet\_cable\_part\_number  
service\_processor\_firmware 1.01

processor: 6 fields  
processor\_location Processor 1  
manufacturer Intel(R) Corporation  
version Intel(R) Xeon(R) CPU E5530 @ 2.40GHz  
speed 2400  
status Enabled  
CPU\_part\_number 46D1266

memory module: 96 fields  
part\_number 44T1493  
device\_location DIMM01  
bank\_location BANK01  
size (MB) No Module Installed  
manufacturer Not Specified  
serial\_number Not Specified

part\_number 44T1493  
device\_location DIMM02  
bank\_location BANK02  
size (MB) 4096  
manufacturer Samsung  
serial\_number 99062848

part\_number 44T1493  
device\_location DIMM03  
bank\_location BANK03  
size (MB) 4096  
manufacturer Samsung  
serial\_number C7062848

...

fan: 12 fields  
part\_number 43V6929  
location location1

part\_number 43V6929  
location location2

part\_number 43V6929  
location location3

...

Adapter card: 18 fields  
card\_type FC card  
part\_number 31P1337  
port\_numbers 1 2 3 4  
location 0  
device\_serial\_number 11S31P1333YM10MY96A206  
manufacturer IBM  
device QE8  
card\_revision 2  
chip\_revision 2.0

card\_type SAS card  
part\_number 44E8690  
port\_numbers 1 2 3 4  
location 0  
device\_serial\_number 11S31P1299YM10MY948004  
manufacturer IBMHUR  
device Capri-PMC8001  
card\_revision Y  
chip\_revision 1.1

```
Fibre Channel SFP: 48 fields
part_number 17P9211
manufacturer JDSU
device PLRXPLVCSH4921
serial_number C915EB06V
supported_speeds 2,4,8
connector_type LC
transmitter_type SN
wavelength 850
max_distance_by_cable_type OM1:20,OM2:50,OM3:150
hw_revision 1
port_number 1
WWPN 500507680140350d
...
```

```
device: 15 fields
part_number 31P1339
bus USB
device 0
model IBM USB Endeavour
revision 1.0
serial_number NA
approx_capacity 0
hw_revision 0
```

```
part_number 42D0673
bus scsi
device 0
model ST973452SS
revision B623
serial_number 3TA00BZ20109B623
approx_capacity 68
```

```
software: 8 fields
code_level 5.1.0.0 (build 16.1.0906240000)
node_name node1
ethernet_status 1
```

```
ethernet_status 0
WWNN 0x500507680100350d
id 1
MAC_address 00 21 5e 09 09 08
MAC_address 00 21 5e 09 09 0a
```

```
front panel assembly: 3 fields
part_number 31P1339
front_panel_id 161040
front_panel_locale en_US
```

```
UPS: 10 fields
electronics_assembly_part_number 64P8326
battery_part_number 31P0710
UPS_assembly_part_number 64P8326
input_power_cable_part_number CountryDependent
UPS_serial_number 1000840050
UPS_type 2145UPS 1U
UPS_internal_part_number P31P0875
UPS_unique_id 0x20400002047c0140
UPS_main_firmware 1.02
UPS_comms_firmware 1.20
```

```
Direct attached managed disk: 56 fields
part_number 41Y84xx
drive_location 0
manufacturer IBM-SSG
model Z16IZD2B-146
serial_number S093A00Y
```



data has its own row, and if the headers are displayed, the data is separated from the header by a space. The **-delim** parameter overrides this behavior. Valid input for the **-delim** parameter is a one-byte character. If you enter `-delim :` on the command line, the colon character (`:`) separates all items of data in a concise view; for example, the spacing of columns does not occur. In a detailed view, the data is separated from its header by the specified delimiter.

#### *ethernet\_port\_id*

(Optional) Specifies the ID of an ethernet port (1, 2, 3 or 4). If omitted, a concise view is displayed for all ports. When you use this parameter, the detailed view of the specified port is returned and any value that is specified by the **-filtervalue** parameter is ignored. If you do not use the *ethernet\_port\_id* parameter, the concise view displays all ports matching the filtering requirements that are specified by the **-filtervalue** parameter.

| **-mtu** *mtu* | *defaultmtu*

| (Optional) Specifies the maximum transmission unit (MTU). The default is 1500, with a maximum of  
| 9000. An MTU of 9000 enables you to save CPU utilization for packets of 4 K and over in size. The  
| increased MTU provides you with improved iSCSI performance.

## Description

This command lists all port IP addresses for each node in the cluster. The concise view displays two rows of output for each ethernet port. Each node has two ethernet ports.

Use the **lspportip** command with the optional **ethernet\_port\_id** parameter to display a detailed view of the specified port.

Both output rows for a port show the MAC address of that port if it can be determined. If the node and the ethernet link are online, the rows also show the speed and duplex state of the link. The duplex field can have values of `Half` or `Full`, or it is blank if the node is offline.

The first row for each port shows any iSCSI addresses that have been configured for that port and are not failed over to a different node. The failover field on this row is set to `no`. The second row for each port shows any iSCSI addresses that have been configured for the partner node, or for the local node with failover, and that are active on the port. The failover field on this row is set to `yes`.

The state field is set to `unconfigured` if there are no iSCSI addresses configured on the port. The state field is set to `offline` if there are configured addresses but the link is down, and `online` if the link is up. Any offline rows indicate a potential problem.

### A concise invocation example

```
lspportip -delim :
```

### The concise resulting output

```
id:node_id:node_name:IP_address:mask:gateway:IP_address_6:
prefix_6:gateway_6:MAC:duplex:state:speed:failover
1:1:dvt101794:9.71.47.129:255.255.254.0:9.71.46.1:::00:14:
 5e:33:51:92:Half:online:100Mb/s:no
1:1:dvt101794:::00:14:5e:33:51:92:Half:online:100Mb/s:yes
2:1:dvt101794:::00:14:5e:33:51:93::unconfigured::no
2:1:dvt101794:::00:14:5e:33:51:93::unconfigured::yes
1:2:dvt101760:9.71.47.83:255.255.254.0:9.71.46.1:::00:14:5e:
 7e:2a:58:Half:online:100Mb/s:no
1:2:dvt101760:::00:14:5e:7e:2a:58:Half:online:100Mb/s:yes
2:2:dvt101760:::00:14:5e:7e:2a:59::unconfigured::no
2:2:dvt101760:::00:14:5e:7e:2a:59::unconfigured::yes
1:3:dvt101761:9.71.47.253:255.255.254.0:9.71.46.1:::00:14:5e:
 33:50:fa:Half:online:100Mb/s:no
1:3:dvt101761:::00:14:5e:33:50:fa:Half:online:100Mb/s:yes
2:3:dvt101761:::00:14:5e:33:50:fb::unconfigured::no
```

```

2:3:dvt101761:::::00:14:5e:33:50:fb::unconfigured::yes
1:4:dvt101786:9.71.47.227:255.255.254.0:9.71.46.1::::00:14:5e:
 33:50:da:Half:online:100Mb/s:no
1:4:dvt101786:::::00:14:5e:33:50:da:Half:online:100Mb/s:yes
2:4:dvt101786:::::00:14:5e:33:50:db::unconfigured::no
2:4:dvt101786:::::00:14:5e:33:50:db::unconfigured::yes
1:5:destiny35:9.71.47.69:255.255.254.0:9.71.46.1::::00:21:5e:09:
 21:44:Full:online:1Gb/s:no
1:5:destiny35:::::00:21:5e:09:21:44:Full:online:1Gb/s:yes
2:5:destiny35:::::00:21:5e:09:21:46::unconfigured::no
2:5:destiny35:::::00:21:5e:09:21:46::unconfigured::yes
1:6:destiny34:9.71.46.239:255.255.254.0:9.71.46.1::::00:21:5e:09:
 21:54:Full:online:100Mb/s:no
1:6:destiny34:::::00:21:5e:09:21:54:Full:online:100Mb/s:yes
2:6:destiny34:::::00:21:5e:09:21:56::unconfigured::no
2:6:destiny34:::::00:21:5e:09:21:56::unconfigured::yes

```

## A detailed invocation example

```
lsportip 1
```

## The detailed resulting output

```

id 1
node_id 1
node_name dvt101794
IP_address 9.8.7.1
mask 255.255.255.0
gateway 9.0.0.1
IP_address_6
prefix_6
gateway_6
MAC 00:14:5e:33:51:92
duplex Half
state online
speed 100Mb/s
failover no
mtu 1500

```

---

## lsquorum

The **lsquorum** command lists the managed disks (MDisks) or drives that the cluster is currently using to store quorum data.

## Syntax

```

▶▶ lsquorum — [-nohdr] [-delim delimiter] [quorum_index] ▶▶

```

## Parameters

### -nohdr

(Optional) By default, headings are displayed for each column of data in a concise style view, and for each item of data in a detailed style view. The **nohdr** parameter suppresses the display of these headings.

**Note:** If there is no data to be displayed, headings are not displayed.

### -delim *delimiter*

(Optional) By default in a concise view, all columns of data are space-separated. The width of each column is set to the maximum possible width of each item of data. In a detailed view, each item of data has its own row, and if the headers are displayed, the data is separated from the header by a

space. The **delim** parameter overrides this behavior. Valid input for the **delim** parameter is a one-byte character. If you enter `-delim :` on the command line, the colon character (`:`) separates all items of data in a concise view; for example, the spacing of columns does not occur. In a detailed view, the data is separated from its header by the specified character.

#### *quorum\_index*

(Optional) Specifies the quorum disk or drive by its index number. The number can be either 0, 1, or 2. When you use this parameter, a detailed view of the specified disk or drive is returned. If you do not specify a disk or drive, then a concise view of all quorum disks or drives is displayed.

## Description

This command displays a concise list or a detailed view of the MDisks or drives that the cluster is currently using to store quorum data. This information can be used to ensure that the quorum candidates are on separate storage subsystems.

**Note:** The object type is either MDisk or drive. SAN Volume Controller uses only MDisks to hold quorum data. If the quorum object type is a drive, the controller ID and name fields are blank.

### A concise invocation example

```
lsquorum
```

#### The concise resulting output

| quorum_index | status | id | name   | controller_id | controller_name | active | object_type |
|--------------|--------|----|--------|---------------|-----------------|--------|-------------|
| 0            | online | 1  | mdisk1 | 1             | controller1     | yes    | mdisk       |
| 1            | online | 2  | mdisk2 | 1             | controller1     | no     | mdisk       |
| 2            | online | 33 |        |               |                 | no     | drive       |

### A detailed invocation example

```
lsquorum 1
```

#### The detailed resulting output

```
quorum_index 2
status online
id 33
name
controller_id
controller_name
active no
object_type drive
```

---

## lsrconsistgrp

The **lsrconsistgrp** command returns a concise list or a detailed view of Metro or Global Mirror consistency groups visible to the cluster.

## Syntax

```

▶▶▶ lsrconsistgrp — [-filtervalue — attrib=value] [-nohdr]
▶ [-delim — delimiter] [-filtervalue?] [object_id]
 [object_name]

```

## Parameters

### **-filtervalue** *attrib=value*

(Optional) Specifies a list of one or more filters. Only objects with a value that matches the filter attribute value are displayed. If a capacity is specified, the units must also be included.

**Note:** Some filters allow the use of a wildcard when you enter the command. The following rules apply to the use of wildcards with the SAN Volume Controller CLI:

- The wildcard character is an asterisk (\*).
- The command can contain a maximum of one wildcard, which must be the first or last character in the string.
- When using a wildcard, you must enclose the filter entry with double quotation marks (""), as follows:

```
lsrconsistgrp -filtervalue "name=md*"
```

### **-nohdr**

(Optional) By default, headings are displayed for each column of data in a concise style view, and for each item of data in a detailed style view. The **-nohdr** parameter suppresses the display of these headings.

**Note:** If there is no data to be displayed, headings are not displayed.

### **-delim** *delimiter*

(Optional) By default in a concise view, all columns of data are space-separated. The width of each column is set to the maximum possible width of each item of data. In a detailed view, each item of data has its own row, and if the headers are displayed the data is separated from the header by a space. The **-delim** parameter overrides this behavior. Valid input for the **-delim** parameter is a one-byte character. If you enter `-delim :` on the command line, the colon character (:) separates all items of data in a concise view; for example, the spacing of columns does not occur. In a detailed view, the data is separated from its header by the specified delimiter.

### *object\_id* | *object\_name*

(Optional) Specifies the name or ID of an object. When you use this parameter, the detailed view of the specific object is displayed and any value that is specified by the **-filtervalue** parameter is ignored. If you do not specify the *object\_id* | *object\_name* parameter, the concise view of all objects matching the filtering requirements that is specified by the **-filtervalue** parameter are displayed.

### **-filtervalue?**

(Optional) Specifies that you want your report to display any or all of the list of valid filter attributes. The following filter attributes for the **lsrconsistgrp** command are valid:

- group\_id
- name
- master\_cluster\_id
- master\_cluster\_name
- aux\_cluster\_id
- aux\_cluster\_name
- primary
- state
- relationship\_count
- id
- copy\_type



## Description

This command returns a concise list or a detailed view of Metro or Global Mirror consistency groups that are visible to the cluster.

Table 41 provides possible values for the attributes that are displayed as data in the output views.

Table 41. `lsrcconsistgrp` command output values

| Attribute   | Value                                                                                                                                                                           |
|-------------|---------------------------------------------------------------------------------------------------------------------------------------------------------------------------------|
| primary     | n/a, master, aux                                                                                                                                                                |
| state       | inconsistent_stopped, inconsistent_copying, consistent_stopped, consistent_synchronized, idling, idling_disconnected, inconsistent_disconnected, consistent_disconnected, empty |
| freeze_time | The time in YY/MM/DD/HH/MM format.                                                                                                                                              |
| status      | online, primary_offline, secondary_offline                                                                                                                                      |
| sync        | in_sync, out_of_sync                                                                                                                                                            |
| copy_type   | metro, global, empty_group                                                                                                                                                      |

**Note:** The names of the Metro or Global Mirror relationships and consistency groups might be blank if the relationship or consistency groups are intercluster and the cluster partnership is disconnected.

The sync attribute has a value of `in_sync` when the contents are synchronized (identical) between VDisks (volumes). If write operations take place on either the primary or secondary volume after a consistent (stopped) or idling state occurs, they will no longer be synchronized.

### A concise invocation example

```
lsrcconsistgrp -delim :
```

### The concise resulting output

```
id:name:master_cluster_id:master_cluster_name:aux_cluster_id:aux_cluster_name:
primary:state:relationship_count:copy_type

 248:jdemo_BA_cons1:0000020060406746:clusterB:0000020061413ABA:clusterA:master:
consistent_stopped:2:global
 249:rccstgrp0:0000020061413ABA:clusterA:0000020061413ABA:clusterA::empty:0
:empty_group
 250:jdemo_BA_cons2:0000020060406746:clusterB:0000020061413ABA:clusterA:master:
inconsistent_stopped:1:metro
 251:BA_cons1:0000020060406746:clusterB:0000020061413ABA:clusterA:master:
consistent_stopped:4:metro
 252:AB_cons2:0000020061413ABA:clusterA:0000020060406746:clusterB::empty:0
:empty_group
 253:AB_cons1:0000020061413ABA:clusterA:0000020060406746:clusterB:aux:
consistent_stopped:3:global
 254:AA_cons2:0000020061413ABA:clusterA:0000020061413ABA:clusterA::empty:0
:empty_group
 255:AA_cons1:0000020061413ABA:clusterA:0000020061413ABA:clusterA:master:
consistent_synchronized:2:global
```

### A detailed invocation example

```
lsrcconsistgrp -delim : 254
```

### The detailed resulting output

```
id:254
name:rccstgrp0
master_cluster_id:0000010030A007E5
```

```

master_cluster_name:clusterA
aux_cluster_id:0000010030A007E5
aux_cluster_name:clusterA
primary:master
state:inconsistent_stopped
relationship_count:1
freeze_time:
status:online
sync:in_sync
copy_type:metro
RC_rel_id:2
RC_rel_name:aaa

```

## Isrcrelationship

The **Isrcrelationship** command returns a concise list or a detailed view of Metro or Global Mirror relationships visible to the clustered system.

### Syntax

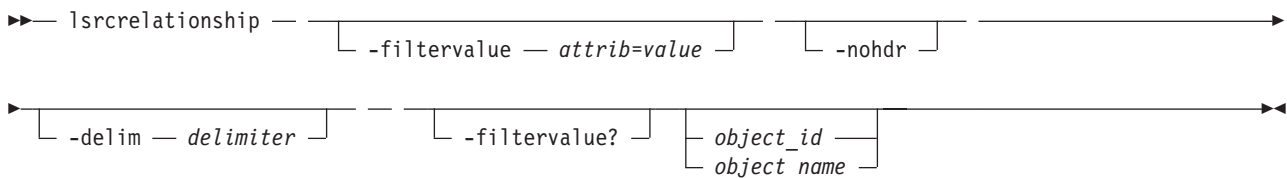

### Parameters

#### **-filtervalue** *attribute=value*

(Optional) Specifies a list of one or more filters. Only objects with a value that matches the filter attribute value are returned. If a capacity is specified, the units must also be included.

**Note:** Some filters allow the use of a wildcard when you enter the command. The following rules apply to the use of wildcards with the SAN Volume Controller CLI:

- The wildcard character is an asterisk (\*).
- The command can contain a maximum of one wildcard, which must be the first or last character in the string.
- When using a wildcard, you must enclose the filter entry with double quotation marks (" "), as follows:

```
Isrcrelationship -filtervalue "name=md*"
```

#### **-nohdr**

(Optional) By default, headings are displayed for each column of data in a concise style view, and for each item of data in a detailed style view. The **-nohdr** parameter suppresses the display of these headings.

**Note:** If there is no data to be displayed, headings are not displayed even if the **-nohdr** parameter is specified.

#### **-delim** *delimiter*

(Optional) By default in a concise view, all columns of data are space-separated. The width of each column is set to the maximum possible width of each item of data. In a detailed view, each item of data has its own row, and if the headers are displayed the data is separated from the header by a space. The **-delim** parameter overrides this behavior. Valid input for the **-delim** parameter is a one-byte character. If you enter **-delim :** on the command line, the colon character (:) separates all items of data in a concise view; for example, the spacing of columns does not occur. In a detailed view, the data is separated from its header by the specified delimiter.

*object\_id* | *object\_name*

(Optional) Specifies the name or ID of an object. When you use this parameter, the detailed view of the specific object is returned and any value that is specified by the **-filtervalue** parameter is ignored. If you do not specify the *object\_id* | *object\_name* parameter, the concise view of all objects matching the filtering requirements that are specified by the **-filtervalue** parameter are displayed.

#### **-filtervalue?**

(Optional) Specifies that you want your report to display any or all of the list of valid filter attributes. The valid filter attributes for the **lsrcrelationship** command are:

- RC\_rel\_id
- RC\_rel\_name
- master\_cluster\_id
- master\_cluster\_name
- master\_vdisk\_id
- master\_vdisk\_name
- aux\_cluster\_id
- aux\_cluster\_name
- aux\_vdisk\_id
- aux\_vdisk\_name
- primary
- consistency\_group\_id
- consistency\_group\_name
- state
- progress
- copy\_type

## **Description**

This command returns a concise list or a detailed view of Metro or Global Mirror relationships visible to the .

Table 42 provides possible values for the attributes that are displayed as data in the output views.

*Table 42. lsrcrelationship command attributes and values*

| <b>Attribute</b> | <b>Value</b>                                                                                                                                                             |
|------------------|--------------------------------------------------------------------------------------------------------------------------------------------------------------------------|
| primary          | n/a, master, aux                                                                                                                                                         |
| state            | inconsistent_stopped, inconsistent_copying, consistent_stopped, consistent_synchronized, idling, idling_disconnected, inconsistent_disconnected, consistent_disconnected |
| progress         | 0-100, n/a                                                                                                                                                               |
| freeze time      | The time in YY/MM/DD/HH/MM format.                                                                                                                                       |
| status           | online, primary_offline, secondary_offline                                                                                                                               |
| sync             | n/a, in_sync, out_of_sync                                                                                                                                                |
| copy_type        | metro, global                                                                                                                                                            |

**Note:** The names of the Metro or Global Mirror relationships and consistency groups can be blank if the relationship or consistency groups are inter-clustered system and the clustered system partnership is disconnected.

The sync attribute has a value of in\_sync when the contents are synchronized (identical) between VDisks (volumes). If write operations take place on either the primary or secondary volume after a consistent (stopped) or idling state occurs, they will no longer be synchronized.

### A concise and detailed invocation example

```
lsrcrelationship -delim : -filtervalue name=j*
```

### The concise and detailed resulting output

```
id:name:master_cluster_id:master_cluster_name:master_vdisk_id:master_vdisk_name:
aux_cluster_id:aux_cluster_name:aux_vdisk_id:
aux_vdisk_name:primary:consistency_group_id:consistency_group_name:state:bg_copy
_priority:progress: copy_type
45:jre1_AB1:0000020061413ABA:clusterA:45:jdisk_B8:0000020060406746:clusterB:38:j
disk_B1:master:::consistent_stopped:50:metro
48:jre1_AB2:0000020061413ABA:clusterA:48:jdisk_A4:0000020060406746:clusterB:41:j
disk_B4:master:::consistent_synchronized:50:metro
49:jre1_BA_1:0000020060406746:clusterB:42:jdisk_B5:0000020061413ABA:clusterA:49:j
disk_A5:master:248:jdemo_BA_cons1:consistent_stopped:50:metro
50:jre1_BA_2:0000020060406746:clusterB:43:jdisk_B6:0000020061413ABA:clusterA:
50:jdisk_A6:master:248:jdemo_BA_cons1:consistent_stopped:50:metro
```

### A detailed invocation example

```
lsrcrelationship -delim : AB_2
```

### The detailed resulting output

```
id:9
name:AB_2
master_cluster_id:0000020061413ABA
master_cluster_name:clusterA
master_vdisk_id:9
master_vdisk_name:stripe9
aux_cluster_id:0000020060406746
aux_cluster_name:clusterB
aux_vdisk_id:9
aux_vdisk_name:stripe9_b
primary:master
consistency_group_id:
consistency_group_name:
state:consistent_stopped
bg_copy_priority:50
progress:
freeze_time:2006/05/05/08/26/46
status:secondary_offline
sync:in_sync
copy_type:metro
```

---

## lsrcrelationshipcandidate

The **lsrcrelationshipcandidate** command lists VDisks that are eligible to form Metro or Global Mirror relationships. You can list eligible VDisks that are on the local or remote cluster.

### Syntax

```
➔— lsrcrelationshipcandidate —————➔
 |_____
 | -master |_____
 | |_____
 | | master_vdisk_id |_____
 | |_____
 | | master_vdisk_name |_____
 | |_____
```

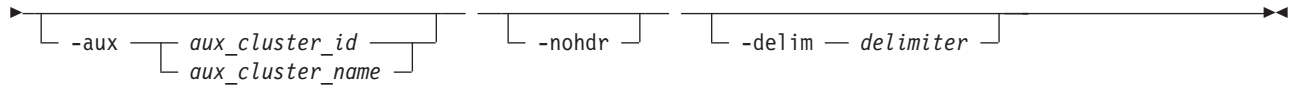

## Parameters

**-master** *master\_vdisk\_id* | *master\_vdisk\_name*

(Required) Specifies a particular VDisk to use as the master VDisk. The command finds candidates that match the size of this VDisk. If you are requesting candidate VDIs on the local cluster, this command also matches the *io\_group*.

**-aux** *aux\_cluster\_id* | *aux\_cluster\_name*

(Required) Specifies a remote cluster with VDisk candidates for an intercluster relationship. If you do not specify this parameter, the candidates on the local cluster are displayed.

**-nohdr**

(Optional) By default, headings are displayed for each column of data in a concise style view, and for each item of data in a detailed style view. The **-nohdr** parameter suppresses the display of these headings.

**Note:** If there is no data to be displayed, headings are not displayed.

**-delim** *delimiter*

(Optional) By default in a concise view, all columns of data are space-separated. The width of each column is set to the maximum possible width of each item of data. In a detailed view, each item of data has its own row, and if the headers are displayed, the data is separated from the header by a space. The **-delim** parameter overrides this behavior. Valid input for the **-delim** parameter is a one-byte character. If you enter `-delim :` on the command line, the colon character (`:`) separates all items of data in a concise view; for example, the spacing of columns does not occur. In a detailed view, the data is separated from its header by the specified delimiter.

## Description

This command displays a list of VDIs that can be either the master or the auxiliary disk for a Metro or Global Mirror relationship. VDisk IDs and names are displayed.

### An invocation example

```
lsrelationshipcandidate -delim :
```

### The resulting output

```
id:vdisk_name
0:vdisk0
4:vdisk4
```

---

## lsrelationshipprogress

You can use the **lsrelationshipprogress** command to display the progress of the background copy of a Metro Mirror or Global Mirror relationship as a percentage. When the initial background copy process for a relationship has completed, null is displayed for the progress of that relationship.

## Syntax

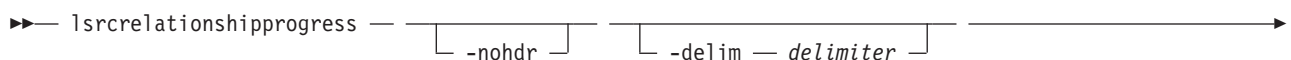



## Parameters

### **-nohdr**

(Optional) By default, headings are displayed for each column of data in a concise style view, and for each item of data in a detailed style view. The **-nohdr** parameter suppresses the display of these headings.

**Note:** If there is no data to be displayed, headings are not displayed.

### **-delim delimiter**

(Optional) By default in a concise view, all columns of data are space-separated. The width of each column is set to the maximum possible width of each item of data. In a detailed view, each item of data has its own row, and if the headers are displayed, the data is separated from the header by a space. The **-delim** parameter overrides this behavior. Valid input for the **-delim** parameter is a one-byte character. If you enter `-delim :` on the command line, the colon character (`:`) separates all items of data in a concise view; for example, the spacing of columns does not occur. In a detailed view, the data is separated from its header by the specified delimiter.

`rcrelationship_id | rcrelationship_name`

Specifies the object ID or name of the specified type.

## Description

This command displays the progress of the background copy of a Metro Mirror or Global Mirror relationship as a percentage.

### An invocation example

```
lsrcrelationshipprogress -delim : 0
```

### The resulting output

```
id:progress
0:58
```

---

## lsrepairsevdiskcopyprogress

The **lsrepairsevdiskcopyprogress** command lists the repair progress for space-efficient volume copies.

## Syntax

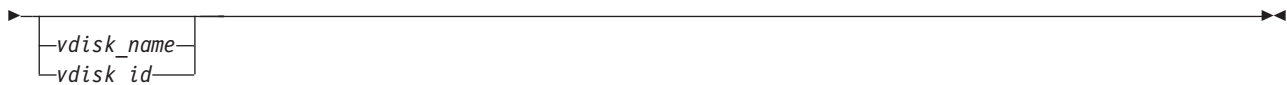

## Parameters

### **-delim delimiter**

(Optional) By default in a concise view, all columns of data are space-separated. The width of each column is set to the maximum possible width of each item of data. In a detailed view, each item of data has its own row, and if the headers are displayed, the data is separated from the header by a space. The **-delim** parameter overrides this behavior. Valid input for the **-delim** parameter is a

one-byte character. If you enter `-delim :` on the command line, the colon character (`:`) separates all items of data in a concise view; for example, the spacing of columns does not occur. In a detailed view, the data is separated from its header by the specified delimiter.

**-copy *id***

(Optional) Lists the repair progress for the specified copy.

**-nohdr**

(Optional) By default, headings are displayed for each column of data in a concise style view, and for each item of data in a detailed style view. The **-nohdr** parameter suppresses the display of these headings.

**Note:** If there is no data to be displayed, headings are not displayed.

***vdisk\_name* | *vdisk\_id***

(Optional) Specifies the volume name or ID to list repair progress for. You must specify this parameter last on the command line. If you do not enter this parameter, the command lists progress for all space-efficient copies in the clustered system.

## Description

The **lsrepairsevdiskcopyprogress** command lists the repair progress for space-efficient copies of the specified volume. If you do not specify a volume, the command lists the repair progress for all space-efficient copies in the clustered system.

**Note:** Only run this command after running the **repairsevdiskcopy** command, which you must only run as required by the fix procedures or by IBM support.

### An invocation example

```
lsrepairsevdiskcopyprogress -delim :
```

### The resulting output

```
id:name:copy id:task:progress:estimated_completion_time
0:vdisk0:0:repairing:50:070301120000
0:vdisk0:1:repairing:51:070301120000
1:vdisk1:0:repairing:32:070301153500
```

### An invocation example

```
lsrepairsevdiskcopyprogress -delim : vdisk0
```

### The resulting output

```
id:name:copy id:task:progress:estimated_completion_time
0:vdisk0:0:repairing:50:070301120000
0:vdisk0:1:repairing:51:070301120000
```

### An invocation example

```
lsrepairsevdiskcopyprogress -delim : -copy 1 vdisk0
```

### The resulting output

```
id:name:copy id:task:progress:estimated_completion_time
0:vdisk0:1:repairing:51:070301120000
```

---

## lsrepairvdiskcopyprogress

The **lsrepairvdiskcopyprogress** command displays the progress of volume repairs and validations.

## Syntax

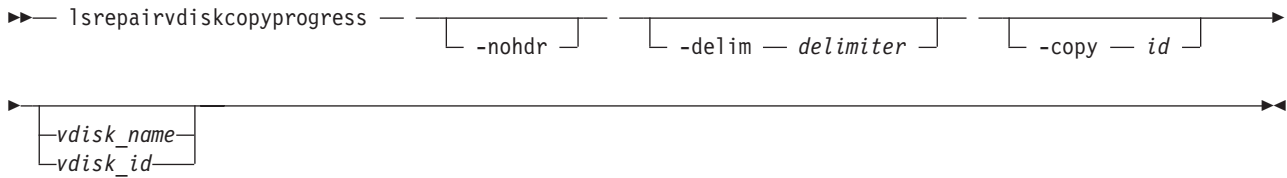

## Parameters

### **-nohdr**

(Optional) By default, headings are displayed for each column of data in a concise style view, and for each item of data in a detailed style view. The **-nohdr** parameter suppresses the display of these headings.

**Note:** If there is no data to be displayed, headings are not displayed.

### **-delim delimiter**

(Optional) By default in a concise view, all columns of data are space-separated. The width of each column is set to the maximum possible width of each item of data. In a detailed view, each item of data has its own row, and if the headers are displayed, the data is separated from the header by a space. The **-delim** parameter overrides this behavior. Valid input for the **-delim** parameter is a one-byte character. If you enter **-delim :** on the command line, the colon character (:) separates all items of data in a concise view; for example, the spacing of columns does not occur. In a detailed view, the data is separated from its header by the specified delimiter.

### **-copy id**

(Optional) Specifies the volume copy ID to list repair progress for. If you do not specify this parameter, progress is displayed for all copies.

### **vdisk\_name | vdisk\_id**

(Optional) Specifies the volume name or ID to list repair progress for. You must specify this parameter last on the command line.

## Description

The **lsrepairvdiskcopyprogress** command displays the progress of repairs and validations being made to mirrored volumes. Use this command to track progress after running the **repairvdiskcopy** command. You can specify a volume copy using the **-copy id** parameter. To display the volumes that have two or more copies with an active task, specify the command with no parameters; it is not possible to have only one volume copy with an active task.

The command displays progress for the following types of volume copies:

- All volume copies display the same task; validate, medium or resync, depending on the specified parameter.
- All volume copies display the same percentage and estimated completion time.
- If specified, non-mirrored volumes are displayed as a single copy with a blank task; they are not displayed in the full concise view.
- Once a task completes, the task is blank for all copies.
- If the task is blank, the percentage and the completion time are also blank.

### An invocation example

```
lsrepairvdiskcopyprogress -delim :
```

### The resulting output



```
vdisk_id:vdisk_name:copy_id:task:progress:estimated_completion_time
0:vdisk0:0:medium:50:070301120000
0:vdisk0:1:medium:50:070301120000
```

### An invocation example

```
lsrepairvdiskcopyprogress -delim : vdisk0
```

### The resulting output

```
vdisk_id:vdisk_name:copy_id:task:progress:estimated_completion_time
0:vdisk0:0:medium:50:070301120000
0:vdisk0:1:medium:50:070301120000
```

### An invocation example

```
lsvdiskcopyrepairprogress -delim : -copy 0 vdisk0
```

### The resulting output

```
vdisk_id:vdisk_name:copy_id:task:progress:estimated_completion_time
0:vdisk0:0:medium:50:070301120000
```

---

## lsrmvdiskdependentmaps

The **lsrmvdiskdependentmaps** command displays all FlashCopy mappings that must be stopped for the specified volume to be deleted.

### Syntax

```
➤— lsrmvdiskdependentmaps — [-nohdr] [-delim delimiter] [vdisk_name | vdisk_id] ➤
```

### Parameters

#### **-nohdr**

(Optional) By default, headings are displayed for each column of data in a concise style view, and for each item of data in a detailed style view. The **-nohdr** parameter suppresses the display of these headings.

**Note:** If there is no data to be displayed, headings are not displayed.

#### **-delim *delimiter***

(Optional) By default in a concise view, all columns of data are space-separated. The width of each column is set to the maximum possible width of each item of data. In a detailed view, each item of data has its own row, and if the headers are displayed, the data is separated from the header by a space. The **-delim** parameter overrides this behavior. Valid input for the **-delim** parameter is a one-byte character. If you enter **-delim :** on the command line, the colon character (:) separates all items of data in a concise view; for example, the spacing of columns does not occur. In a detailed view, the data is separated from its header by the specified delimiter.

*vdisk\_name* | *vdisk\_id*

(Required) Specifies the name or ID of the volume for which the FlashCopy mappings are displayed.

### Description

This command returns a list of the FlashCopy mappings that must be stopped before the specified volume can be deleted. Any mappings that are returned in the list for the volume are automatically stopped when the volume is deleted with the **force** option.

### An invocation example

```
lsrmdiskdependentmaps -delim : 0
```

## The resulting output

```
id:name
2:fcmap2
5:fcmap5
```

---

## Isroute

The **Isroute** command displays the IP routing table.

### Syntax

►► `lsroute` —————►►

### Description

This command displays the IP routing table. The table provides details of the gateway that is used for IP traffic to a range of IP addresses for each ethernet port. This information can be used to diagnose configuration node accessibility problems. The **Isroute** command is equivalent to the Linux **route** command.

### An invocation example

```
lsroute
```

### The resulting output

Kernel IP routing table

| Destination | Gateway   | Genmask       | Flags | Metric | Ref | Use | Iface |
|-------------|-----------|---------------|-------|--------|-----|-----|-------|
| 9.71.46.0   | 0.0.0.0   | 255.255.254.0 | U     | 0      | 0   | 0   | eth0  |
| 127.0.0.0   | 0.0.0.0   | 255.0.0.0     | U     | 0      | 0   | 0   | lo    |
| 0.0.0.0     | 9.71.46.1 | 0.0.0.0       | UG    | 0      | 0   | 0   | eth0  |

Kernel IPv6 routing table

| Destination                              | Next Hop              | Flags | Metric | Ref  | Use | Iface |
|------------------------------------------|-----------------------|-------|--------|------|-----|-------|
| 2002:914:fc12:849::/64                   | ::                    | UA    | 256    | 3675 | 0   | eth0  |
| fe80::/64                                | ::                    | U     | 256    | 0    | 0   | eth0  |
| ::/0                                     | fe80::7:b4ff:fe00:500 | UGDA  | 1024   | 1    | 0   | eth0  |
| ::1/128                                  | ::                    | U     | 0      | 1441 | 1   | lo    |
| 2002:914:fc12:849:214:5eff:fe33:5192/128 | ::                    | U     | 0      | 0    | 1   | lo    |
| fe80::214:5eff:fe33:5192/128             | ::                    | U     | 0      | 0    | 1   | lo    |
| ff00::/8                                 | ::                    | U     | 256    | 0    | 0   | eth0  |

---

## Issevdiskcopy

The **Issevdiskcopy** command lists the space-efficient copies of the specified volumes.

### Syntax

►► `lssevdiskcopy` — [ `-nohdr` ] — [ `-bytes` ] — [ `-delim` *delimiter* ] —————►►

► [ `-copy` *id* ] — [ `-filtervalue?` ] — [ `-vdisk_name` ] — [ `-vdisk_id` ] —————►►

## Parameters

### **-nohdr**

(Optional) By default, headings are displayed for each column of data in a concise style view, and for each item of data in a detailed style view. The **-nohdr** parameter suppresses the display of these headings.

**Note:** If there is no data to be displayed, headings are not displayed.

### **-bytes**

(Optional) Displays all capacities as bytes. Capacity values displayed in units other than bytes might be rounded.

### **-delim delimiter**

(Optional) By default in a concise view, all columns of data are space-separated. The width of each column is set to the maximum possible width of each item of data. In a detailed view, each item of data has its own row, and if the headers are displayed, the data is separated from the header by a space. The **-delim** parameter overrides this behavior. Valid input for the **-delim** parameter is a one-byte character. If you enter `-delim :` on the command line, the colon character (`:`) separates all items of data in a concise view; for example, the spacing of columns does not occur. In a detailed view, the data is separated from its header by the specified delimiter.

### **-copy id**

(Optional) Specifies the volume copy to list space-efficient copies for. You must specify a *vdisk\_name* | *vdisk\_id* value with this parameter.

### **-filtervalue?**

(Optional) Displays a list of valid filter attributes. The following filters for the **lssevdiskcopy** command are valid:

- `mdisk_grp_id`
- `mdisk_grp_name`
- `overallocation`
- `autoexpand`
- `grainsize`

### *vdisk\_name* | *vdisk\_id*

(Optional) Specifies the virtual disk name or ID to list space-efficient copies for. You must specify this parameter last on the command line. If you do not enter this parameter, the command lists all space-efficient thin-provisioned volume copies in the clustered system.

## Description

The **lssevdiskcopy** command lists all space-efficient copies of the specified volume. If you do not specify a volume, the command lists all space-efficient volume copies in the clustered system.

The command provides a concise view of the space-efficient properties of the selected volume copies. Run the **lsvdiskcopy** command to see a concise view of the properties that are common to space-efficient and non-space-efficient volume copies. See the description of **lsvdisk** command for a description of the fields that is shown in the view.

The command returns values for the following volume copy attributes:

### **copy\_id**

Specifies a system-assigned identifier for the volume copy. The value can be **0** or **1**.

**status** The value can be **online** or **offline**. A copy is offline if all nodes cannot access the storage pool that contains the copy.

**sync** Indicates whether the volume copy is synchronized.

**primary**

Indicates whether the volume copy is the primary copy. A volume has exactly one primary copy. The value can be **Yes** or **No**.

**mdiskgrp\_id/name**

Specifies the name and ID of the storage pool that the volume copy belongs to.

**type** Specifies the virtualization type of the volume. The value can be **striped**, **sequential** or **image**.

**mdisk\_id/name**

Specifies the MDisk that is used for sequential and image mode volumes.

**fast\_write\_state**

Specifies the cache state of the volume copy. The value can be **empty**, **not\_empty**, **corrupt**, or **repairing**. The value is always empty for non-space-efficient copies. A cache state of **corrupt** indicates that the volume is space-efficient and requires repair that is initiated by a **recovervdisk** command or the **repairsevdiskcopy** command.

**used\_capacity**

Specifies the portion of **real\_capacity** that is being used to store data. For non-space-efficient copies, this value is the same as the volume capacity. If the volume copy is space-efficient, the value increases from zero to the **real\_capacity** value as more of the volume is written to.

**real\_capacity**

Specifies the amount of physical storage that is allocated from an storage pool to this volume copy. If the volume copy is not space-efficient, the value is the same as the volume capacity. If the volume copy is space-efficient, the value can be different.

**free\_capacity**

Specifies the difference between the **real\_capacity** and **used\_capacity** values.

**overalllocation**

Expressed as a percentage, specifies the ratio of volume capacity to **real\_capacity** values. This value is always **100** for non-space-efficient volumes.

**autoexpand**

Specifies whether **autoexpand** is enabled on a space-efficient volume. The value can be **on** or **off**.

**warning**

Expressed as a percentage, for space-efficient volume copies only. A warning is generated when the ratio of **used\_capacity** to volume capacity reaches the specified level.

**grainsize**

For space-efficient volume copies, specifies the grain size chosen for the volume copy when it was created.

**se\_copy**

Specifies if the copy is space-efficient.

**easy\_tier**

This value is set by the user and determines whether Easy Tier is permitted to manage the pool.

**Note:**

1. If **easy\_tier** is *on*, then **easy\_tier\_status** can take on any value.
2. If **easy\_tier** is *off*, then **easy\_tier\_status** is *measured* or *inactive*.

**easy\_tier\_status**

Which Easy Tier functions are active for the volume copy:

- *Active* : may move extents of this volume copy for performance (automatic data placement).
- *Measured*: statistics are being gathered for this volume copy, but no extents will be moved.
- *Inactive* : no Easy Tier function is active.

**tier** Which tier information is being reported:

- generic\_ssd
- generic\_hdd

**tier\_capacity**

The total MDisk capacity assigned to the volume in the tier.

**Note:** For space-efficient copies, the capacity by tier will be the real capacity.

**An invocation example**

```
lssevdiskcopy -delim :
```

**The resulting output**

```
vdisk_id:vdisk_name:copy_id:mdisk_grp_id:mdisk_grp_name:capacity:used_capacity:real_capacity:
free_capacity:overallocation:autoexpand:warning:grainsize
0:vv1:0:0:ppp:16.0GB:5.0MB:4.0GB:15.99GB:400:off:20:32
1:se1:0:0:ppp:16.0GB:1.0GB:4.0GB:15.00GB:400:off:20:32
1:se1:1:0:ppp:16.0GB:2.0GB:8.0GB:14.00GB:200:off:45:256
```

**An invocation example**

```
lssevdiskcopy -delim : -copy 0 0
```

**The resulting output**

```
vdisk_id:0
vdisk_name:vv1
capacity:16.00GB
copy_id:0
status:online
sync:yes
primary:yes
mdisk_grp:1
mdisk_grp name:mdisk_group_1
type:striped
mdisk_id:
mdisk_name:
fast_write_state:not_empty
used_capacity:2.00GB
real_capacity:8.00GB
free_capacity:6.00GB
overallocation:200
autoexpand:on
warning:25
grainsize:256
se_copy:yes
easy_tier:on
easy_tier_status:active
tier:generic_ssd
tier_capacity:64.00MB
tier:generic_hdd
tier_capacity:7.94GB
```

---

## Issnmpserver

The **Issnmpserver** command returns a concise list or a detailed view of SNMP servers that are configured on the cluster.

## Syntax

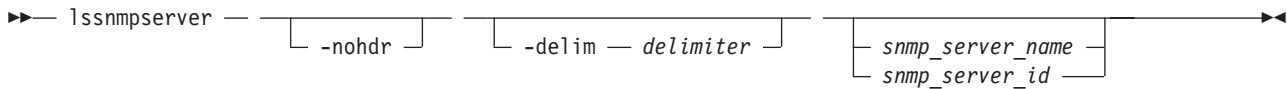

## Parameters

### **-nohdr**

(Optional) By default, headings are displayed for each column of data in a concise style view, and for each item of data in a detailed style view. The **-nohdr** parameter suppresses the display of these headings.

**Note:** If there is no data to be displayed, headings are not displayed.

### **-delim delimiter**

(Optional) By default in a concise view, all columns of data are space-separated. The width of each column is set to the maximum possible width of each item of data. In a detailed view, each item of data has its own row, and if the headers are displayed, the data is separated from the header by a space. The **-delim** parameter overrides this behavior. Valid input for the **-delim** parameter is a one-byte character. If you enter **-delim :** on the command line, the colon character (:) separates all items of data in a concise view; for example, the spacing of columns does not occur. In a detailed view, the data is separated from its header by the specified delimiter.

*snmp\_server\_name | snmp\_server\_id*

(Optional) Specifies the name or ID of an existing SNMP server that must be listed.

## Description

Use this command to display a concise list or a detailed view of SNMP servers that are configured on the cluster.

### A concise invocation example

```
lssnmpserver -delim :
```

### The concise resulting output

```
id:name:IP_address:error:warning:info:port:community
0:snmp0:192.135.60.4:on:on:on:78:public
1:newserver:192.136.70.7:on:off:off:250:newcommunity
```

### A detailed invocation example

```
lssnmpserver snmp0
```

### The detailed resulting output

```
id 0
name snmp0
IP_address 192.135.60.4
error on
warning on
info on
port 78
community public
```

---

## lssoftwareumps (Deprecated)

**Attention:** The **svcinfo lssoftwareumps** command is deprecated. Use the **svcinfo lsdumps** command to display a list of files in a particular dumps directory.

---

## lssoftwareupgradestatus

The `lssoftwareupgradestatus` command displays the status of a software upgrade.

### Syntax

►► `lssoftwareupgradestatus` `[-nohdr]` ►►

### Parameters

**-nohdr**

(Optional) Suppresses the display of headings.

### Description

The `lssoftwareupgradestatus` command displays the status of a software upgrade.

**Note:** If a status of `stalled_non_redundant` is displayed, proceeding with the remaining set of node upgrades might result in offline VDIs. Contact an IBM service representative to complete the manual upgrade.

#### An invocation example

```
lssoftwareupgradestatus
```

#### The resulting output

```
status
upgrading
```

#### An invocation example

```
lssoftwareupgradestatus
```

#### The resulting output

```
status
stalled_non_redundant
```

---

## lstimezones

The `lstimezones` command lists the time zones that are available on the cluster. Each timezone is assigned an ID that can be used in the `settimezone` command to set the time zone.

### Syntax

►► `lstimezones` `[-nohdr]` `[-delim delimiter]` ►►

### Parameters

**-nohdr**

(Optional) By default, headings are displayed for each column of data in a concise style view, and for each item of data in a detailed style view. The **-nohdr** parameter suppresses the display of these headings.

**Note:** If there is no data to be displayed, headings are not displayed.

### **-delim** *delimiter*

(Optional) By default in a concise view, all columns of data are space-separated. The width of each column is set to the maximum possible width of each item of data. In a detailed view, each item of data has its own row, and if the headers are displayed, the data is separated from the header by a space. The **-delim** parameter overrides this behavior. Valid input for the **-delim** parameter is a one-byte character. If you enter **-delim :** on the command line, the colon character (:) separates all items of data in a concise view; for example, the spacing of columns does not occur. In a detailed view, the data is separated from its header by a colon character.

## Description

This command displays a list of all the time zones that are available on the cluster. Each time zone is assigned an ID. This ID can be used in the **settimezone** command.

### An invocation example

```
lstimezones
```

### The resulting output

```
id timezone
0 Africa/Abidjan
1 Africa/Accra
2 Africa/Addis_Ababa
3 Africa/Algiers
4 Africa/Asmera
5 Africa/Bamako
6 Africa/Bangui
```

---

## lsuser

Use the **lsuser** command to display a list of the users that have been created on the cluster.

## Syntax

```
lsuser [-nohdr] [-delim delimiter] [-filtervalue attribute=value] [-filtervalue?] [userid_or_name]
```

## Parameters

### **-nohdr**

(Optional) By default, headings are displayed for each column of data in a concise style view, and for each item of data in a detailed style view. The **-nohdr** parameter suppresses the display of these headings.

**Note:** If there is no data to be displayed, headings are not displayed.

### **-delim** *delimiter*

(Optional) By default in a concise view, all columns of data are space-separated. The width of each column is set to the maximum possible width of each item of data. In a detailed view, each item of data has its own row, and if the headers are displayed, the data is separated from the header by a space. If you enter **-delim :** on the command line, the colon character (:) separates all items of data in a concise view; for example, the spacing of columns does not occur. In a detailed view, the data is separated from its header by the specified delimiter.



**-filtervalue** *attribute=value*

(Optional) Specifies a list of one or more filters. Only objects with a value that matches the filter attribute value are displayed.

**Note:** Some filters allow the use of a wildcard when you enter the command. The following rules apply to the use of wildcards with the SAN Volume Controller CLI:

- The wildcard character is the asterisk (\*), which must be used as the first or last character in the string.
- The command can contain a maximum of one wildcard.
- When you use a wildcard, enclose the filter entry within double quotation marks (""), as follows:  
lsuser -filtervalue "usergrp\_name=md\*"

**-filtervalue?**

(Optional) Displays the valid filter attributes for the **-filtervalue** *attribute=value* parameter:

- password
- ssh\_key
- remote
- usergrp\_id
- usergrp\_name

*userid\_or\_name*

(Optional) Specifies the ID or name of the user for which the association is being deleted. If this is specified, the detailed view for the specified user is displayed in the output. If you do not specify an ID or name, the concise view is displayed.

## Description

This command displays a list of users that have been created on the cluster.

### An invocation example

```
lsuser
```

### The resulting output

| id | name      | password | ssh_key | remote | usergrp_id | usergrp_name  |
|----|-----------|----------|---------|--------|------------|---------------|
| 0  | superuser | yes      | no      | no     | 0          | SecurityAdmin |
| 1  | simon     | no       | yes     | no     | 2          | CopyOperator  |
| 2  | jane      | yes      | no      | no     | 3          | Service       |
| 3  | kip       | yes      | yes     | yes    |            |               |

---

## lsusergrp

Use the **lsusergrp** command to display a list of the user groups that have been created on the cluster.

### Syntax

```
lsusergrp [-nohdr] [-delim delimiter] [-filtervalue attribute=value] [-filtervalue?] [usergrp_id_or_name]
```

## Parameters

### **-nohdr**

(Optional) By default, headings are displayed for each column of data in a concise style view, and for each item of data in a detailed style view. The **-nohdr** parameter suppresses the display of these headings.

**Note:** If there is no data to be displayed, headings are not displayed.

### **-delim** *delimiter*

(Optional) By default in a concise view, all columns of data are space-separated. The width of each column is set to the maximum possible width of each item of data. In a detailed view, each item of data has its own row, and if the headers are displayed, the data is separated from the header by a space. If you enter **-delim :** on the command line, the colon character (:) separates all items of data in a concise view; for example, the spacing of columns does not occur. In a detailed view, the data is separated from its header by the specified delimiter.

### **-filtervalue** *attribute=value*

(Optional) Specifies a list of one or more filters. Only objects with a value that matches the filter attribute value are displayed.

**Note:** Some filters allow the use of a wildcard when you enter the command. The following rules apply to the use of wildcards with the SAN Volume Controller CLI:

- The wildcard character is the asterisk (\*), which must be used as the first or last character in the string.
- The command can contain a maximum of one wildcard.
- When you use a wildcard, enclose the filter entry within double quotation marks (""), as follows:

```
lsusergrp -filtervalue "role=md*"
```

### **-filtervalue?**

(Optional) Displays the valid filter attributes for the **-filtervalue** *attribute=value* parameter:

- role
- remote

### *usergrp\_id\_or\_name*

(Optional) Specifies the ID or name of the user group to view. If you do not specify an ID or name, all groups are displayed.

## Description

This command displays a list of user groups that have been created on the cluster.

### An invocation example

```
lsusergrp
```

### The resulting output

| id | name          | role          | remote |
|----|---------------|---------------|--------|
| 0  | SecurityAdmin | SecurityAdmin | yes    |
| 1  | Administrator | Administrator | no     |
| 2  | CopyOperator  | CopyOperator  | no     |
| 3  | Service       | Service       | yes    |
| 4  | Monitor       | Monitor       | no     |
| 5  | support       | Service       | no     |

---

## lsvdisk

The **lsvdisk** command displays a concise list or a detailed view of volumes that are recognized by the clustered system.

## Syntax

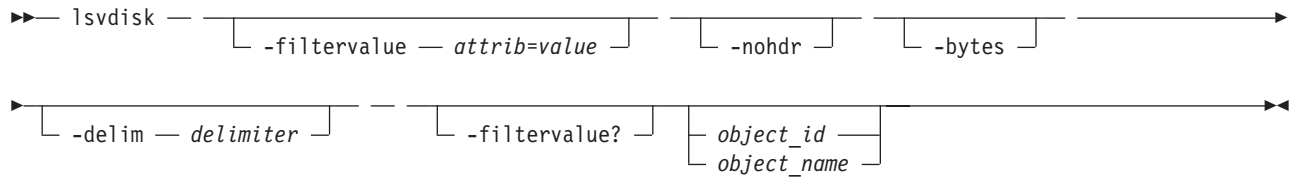

## Parameters

### **-filtervalue** *attrib=value*

(Optional) Specifies a list of one or more filters. Only objects with a value that matches the filter attribute value are displayed. If a capacity is specified, the units must also be included.

### **-nohdr**

(Optional) By default, headings are displayed for each column of data in a concise style view, and for each item of data in a detailed style view. The **-nohdr** parameter suppresses the display of these headings.

**Note:** If there is no data to be displayed, headings are not displayed.

### **-bytes**

(Optional) Displays all capacities as bytes. Capacity values displayed in units other than bytes might be rounded. When filtering on capacity, use a unit of bytes, **-unit b**, for exact filtering. For space efficient copies, the capacity by tier will be the real capacities.

### **-delim** *delimiter*

(Optional) By default in a concise view, all columns of data are space-separated. The width of each column is set to the maximum possible width of each item of data. In a detailed view, each item of data has its own row, and if the headers are displayed, the data is separated from the header by a space. The **-delim** parameter overrides this behavior. Valid input for the **-delim** parameter is a one-byte character. If you enter **-delim :** on the command line, the colon character (:) separates all items of data in a concise view; for example, the spacing of columns does not occur. In a detailed view, the data is separated from its header by the specified delimiter.

### *object\_id* | *object\_name*

(Optional) Specifies the name or ID of an object. When you use this parameter, the detailed view of the specific object is returned and any value that is specified by the **-filtervalue** parameter is ignored. If you do not specify the *object\_id* | *object\_name* parameter, the concise view of all objects matching the filtering requirements that is specified by the **-filtervalue** parameter are displayed.

### **-filtervalue?**

(Optional) Displays a list of valid filter attributes. The following filters for the **lsvdisk** command are valid:

- *vdisk\_name*
- *vdisk\_id*
- *vdisk\_UID*
- *fc\_map\_count*
- *copy\_count*
- *IO\_group\_id*
- *IO\_group\_name*
- *status*
- *mdisk\_grp\_name*
- *mdisk\_grp\_id*
- *capacity*

- type
- FC\_id
- FC\_name
- RC\_id
- RC\_name
- name
- id
- filesystem

**Note:** It is not possible to filter the **lsvdisk** command with `mdisk_grp_name=many` to identify mirrored volumes. Instead, filter on `copy_count=2`.

## Description

This command displays a concise list or a detailed view of attributes for all volumes and volume copies in the clustered system.

The volume is offline and unavailable if one of the following takes place:

- Both nodes in the I/O group are missing.
- None of the nodes in the I/O group that are present can access the volume.
- All synchronized copies for this volumes are in storage pools that are offline.
- The volume is formatting.

If you have a degraded volume and all of the associated nodes and MDisks are online, call the IBM Support Center for assistance. A volume is reported as degraded if any of the following occurs:

- One of the nodes in the I/O group is missing.
- One of the nodes in the I/O group cannot access all the MDisks in the storage pool that the volume spans. In this case MDisks are shown as degraded and the fix procedures for MDisks should be followed to resolve the problem.
- The fast write cache pins data for one or more volumes in the I/O group and is unable to perform a failback until the situation is resolved. An error log indicating that the cache has pinned data is displayed. Follow the fix procedures for this error log to resolve the problem. The most common causes of pinned data are the following:
  - One or more volumes in an I/O group is offline due to an asymmetric failure and has pinned data in the cache. Asymmetric failures can occur because of SAN fabric faults or misconfiguration, back-end controller faults or misconfiguration or because repeated errors has lead to the clustered system excluding access to a MDisk through one or more nodes.
  - One or more volumes in an I/O group is offline due to a problem with a FlashCopy mapping.

The command returns values for the following volume attributes:

### **IO\_groups\_id/name**

Specifies the I/O Group that the volume belongs to.

**status** The value can be **online**, **offline** or **degraded**.

### **mdisk\_grp\_id/name**

Specifies the name and ID of the storage pool that the volume belongs to. If the volume has more than one copy, these fields display **many**.

**type** Specifies the virtualization type of the volume. The value can be **striped**, **sequential**, **image** or **many**. The value **many** indicates that the volume has more than one copy, which can have different virtualization types.

- capacity**  
Specifies the total capacity of the volume.
- formatted**  
Indicates whether the volume was formatted when it was created. The value can be **Yes** or **No**.
- mdisk\_id/name**  
Specifies the MDisk that is used for sequential and image mode volumes. If the volume has more than one copy, these fields display **many**.
- FC\_id/name**  
Specifies the name and ID of the FlashCopy mapping that the volume belongs to. The value **many** indicates that the volume belongs to more than one FlashCopy mapping.
- RC\_id/name**  
Specifies the name and ID of the Global Mirror or Metro Mirror relationship that the volume belongs to.
- vdisk\_UID**  
Specifies the UID of the volume.
- throttling**  
Specifies the throttle rate of the volume.
- preferred\_node\_id**  
Specifies the ID of the preferred node for the volume.
- fast\_write\_state**  
Specifies the cache state for the volume. The value can be **empty**, **not\_empty**, **corrupt**, or **repairing**. A cache state of **corrupt** indicates that the volume requires recovery by using one of the **recovervdisk** commands. A cache state of **repairing** indicates that repairs initiated by a **recovervdisk** command are in progress.
- cache** Specifies the cache mode of the volume. The value can be **readwrite** or **none**.
- udid** Specifies the unit number for the volume. Only OpenVMS hosts require a unit number.
- fc\_map\_count**  
Specifies the number of FlashCopy mappings that the volume belongs to.
- sync\_rate**  
Specifies the rate for synchronization for mirrored copies.
- se\_copy\_count**  
Indicates if the copy is space-efficient:
- yes
  - no

The command returns values for the following volume copy attributes:

- copy\_id**  
Specifies a system-assigned identifier for the volume copy. The value can be **0** or **1**.
- status** The value can be **online** or **offline**. A copy is offline if all nodes cannot access the storage pool that contains the copy.
- sync** Indicates whether the volume copy is synchronized.
- primary**  
Indicates whether the volume copy is the primary copy. A volume has exactly one primary copy. The value can be **Yes** or **No**.
- mdiskgrp\_id/name**  
Specifies the name and ID of the storage pool that the volume copy belongs to.

**type** Specifies the virtualization type of the volume. The value can be **striped**, **sequential** or **image**.

**mdisk\_id/name**

Specifies the MDisk that is used for sequential and image mode volumes.

**fast\_write\_state**

Specifies the cache state of the volume copy. The value can be **empty**, **not\_empty**, **corrupt**, or **repairing**. The value is always empty for non-space-efficient copies. A cache state of **corrupt** indicates that the volume is space-efficient and requires repair that is initiated by a **recovervdisk** command or the **repairsevdiskcopy** command.

**used\_capacity**

Specifies the portion of **real\_capacity** that is being used to store data. For non-space-efficient copies, this value is the same as the volume capacity. If the volume copy is space-efficient, the value increases from zero to the **real\_capacity** value as more of the volume is written to.

**real\_capacity**

Specifies the amount of physical storage that is allocated from an storage pool to this volume copy. If the volume copy is not space-efficient, the value is the same as the volume capacity. If the volume copy is space-efficient, the value can be different.

**free\_capacity**

Specifies the difference between the **real\_capacity** and **used\_capacity** values.

**overalllocation**

Expressed as a percentage, specifies the ratio of volume capacity to **real\_capacity** values. This value is always **100** for non-space-efficient volumes.

**autoexpand**

Specifies whether **autoexpand** is enabled on a space-efficient volume. The value can be **on** or **off**.

**warning**

Expressed as a percentage, for space-efficient volume copies only. A warning is generated when the ratio of **used\_capacity** to volume capacity reaches the specified level.

**grainsize**

For space-efficient volume copies, specifies the grain size chosen for the volume copy when it was created.

**se\_copy**

Specifies if the copy is space-efficient.

**easy\_tier**

This value is set by the user and determines whether Easy Tier is permitted to manage the pool.

**Note:**

1. If **easy\_tier** is *on*, then **easy\_tier\_status** can take on any value.
2. If **easy\_tier** is *off*, then **easy\_tier\_status** is *measured* or *inactive* .

**easy\_tier\_status**

Which Easy Tier functions are active for the volume copy:

- *Active* : may move extents of this volume copy for performance (automatic data placement).
- *Measured*: statistics are being gathered for this volume copy, but no extents will be moved.
- *Inactive* : no Easy Tier function is active.

**tier** The tier information being reported:

- **generic\_ssd**
- **generic\_hdd**

**tier\_capacity**

The total MDisk capacity assigned to the volume in the tier.

**Note:** For space-efficient copies, the capacity by tier will be the real capacity.

### A concise invocation example

```
lsvdisk -delim :
```

### The resulting output

```
id:name:IO_group_id:IO_group_name:status:mdisk_grp_id:mdisk_grp_name:capacity:type:FC_id:
 FC_name:RC_id:RC_name:vdisk_UID:fc_map_count:copy_count:fast_write_state:se_copy_count
0:vdisk0:0:io_grp0:degraded:0:mdiskgrp0:10.00GB:striped:::::60050768018300003000000000000000:0:1
:empty:0
```

### A detailed invocation example for a volume

```
lsvdisk -delim : vv1
id:0
name:vv1
IO_group_id:0
IO_group_name:io_grp0
status:degraded
mdisk_grp_id:many
mdisk_grp_name:many
capacity:16.00GB
type:many
formatted:no
mdisk_id:many
mdisk_name:many
FC_id:
FC_name:
RC_id:
RC_name:
vdisk_UID:0000000000000000AB:6005076801CF003F2800000000000000
throttling:0
preferred_node_id:1
fast_write_state:empty
cache:readwrite
udid:1234
fcmap_count:0
sync_rate:25
copy_count:2
se_copy_count:0
filesystem:filesystem1

copy_id:0
status:online
sync:yes
primary:yes
mdisk_grp:1
mdisk_grp_name:mdisk_group_1
type:striped
mdisk_id:
mdisk_name:
fast_write_state:empty
used_capacity:2.00GB
real_capacity:8.00GB
free_capacity:6.00GB
overallocation:200
autoexpand:on
warning:25
grainsize:256
se_copy:yes
easy_tier:off
easy_tier_status:inactive
tier:generic_ssd
tier_capacity:0.00MB
tier:generic_hdd
tier_capacity:8.00GB
```

```

copy_id:1
status:offline
sync:no
primary:no
mdisk_grp:2
mdisk_grp_name:mdisk_group_2
type:striped
mdisk_id:
mdisk_name:
fast_write_state:not_empty
used_capacity:2.00GB
real_capacity:4.00GB
free_capacity:2.00GB
overallocation:400
autoexpand:on
warning:20
grainsize:256
se_copy:yes
easy_tier:on
easy_tier_status:active
tier:generic_ssd
tier_capacity:64.00MB
tier:generic_hdd
tier_capacity:3.94GB

```

---

## lsvdiskcopy

The `lsvdiskcopy` command lists volume copy information.

### Syntax

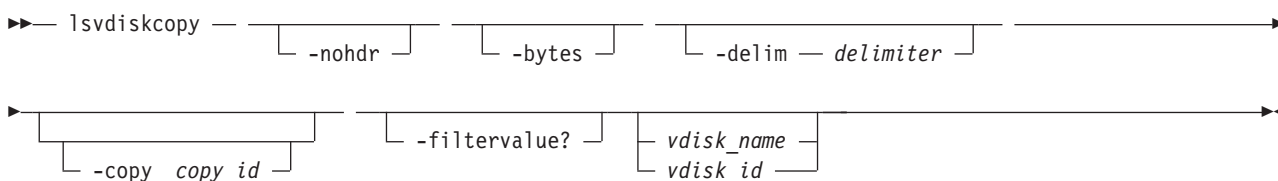

### Parameters

#### **-nohdr**

(Optional) By default, headings are displayed for each column of data in a concise style view, and for each item of data in a detailed style view. The **-nohdr** parameter suppresses the display of these headings.

**Note:** If there is no data to be displayed, headings are not displayed.

#### **-bytes**

(Optional) Displays all capacities as bytes. Capacity values displayed in units other than bytes might be rounded.

#### **-delim delimiter**

(Optional) By default in a concise view, all columns of data are space-separated. The width of each column is set to the maximum possible width of each item of data. In a detailed view, each item of data has its own row, and if the headers are displayed, the data is separated from the header by a space. The **-delim** parameter overrides this behavior. Valid input for the **-delim** parameter is a one-byte character. If you enter `-delim :` on the command line, the colon character (`:`) separates all items of data in a concise view; for example, the spacing of columns does not occur. In a detailed view, the data is separated from its header by the specified delimiter.



**-copy** *copy\_id*

(Optional) Specifies the volume copy to list information for. You must specify a *vdisk\_name* | *vdisk\_id* value with this parameter.

**-filtervalue?**

(Optional) Displays a list of valid filter attributes. The following filters for the **lsvdiskcopy** command are valid:

- primary
- status
- sync
- mdisk\_grp\_id
- mdisk\_grp\_name
- type
- easy\_tier
- easy\_tier\_status

*vdisk\_name* | *vdisk\_id*

(Optional) Specifies the volume to list copy information for. You must specify this parameter last on the command line. If you specify a *vdisk\_name* | *vdisk\_id* value only, all copies for the volume are listed.

## Description

The **lsvdiskcopy** command lists information for volume copies. If you specify the command with no parameters, all volumes and copies in the clustered system are listed.

The command returns values for the following volume copy attributes:

**copy\_id**

Specifies a system-assigned identifier for the volume copy. The value can be **0** or **1**.

**status** The value can be **online** or **offline**. A copy is offline if all nodes cannot access the storage pool that contains the copy.

**sync** Indicates whether the volume copy is synchronized.

**primary**

Indicates whether the volume copy is the primary copy. A volume has exactly one primary copy. The value can be **Yes** or **No**.

**mdiskgrp\_id/name**

Specifies the name and ID of the storage pool that the volume copy belongs to.

**type** Specifies the virtualization type of the volume. The value can be **striped**, **sequential** or **image**.

**mdisk\_id/name**

Specifies the MDisk that is used for sequential and image mode volumes.

**fast\_write\_state**

Specifies the cache state of the volume copy. The value can be **empty**, **not\_empty**, **corrupt**, or **repairing**. The value is always empty for non-space-efficient copies. A cache state of **corrupt** indicates that the volume is space-efficient and requires repair that is initiated by a **recovervdisk** command or the **repairsevdiskcopy** command.

**used\_capacity**

Specifies the portion of **real\_capacity** that is being used to store data. For non-space-efficient copies, this value is the same as the volume capacity. If the volume copy is space-efficient, the value increases from zero to the **real\_capacity** value as more of the volume is written to.

**real\_capacity**

Specifies the amount of physical storage that is allocated from an storage pool to this volume copy. If the volume copy is not space-efficient, the value is the same as the volume capacity. If the volume copy is space-efficient, the value can be different.

**free\_capacity**

Specifies the difference between the **real\_capacity** and **used\_capacity** values.

**overalllocation**

Expressed as a percentage, specifies the ratio of volume capacity to **real\_capacity** values. This value is always **100** for non-space-efficient volumes.

**autoexpand**

Specifies whether **autoexpand** is enabled on a space-efficient volume. The value can be **on** or **off**.

**warning**

Expressed as a percentage, for space-efficient volume copies only. A warning is generated when the ratio of **used\_capacity** to volume capacity reaches the specified level.

**grainsize**

For space-efficient volume copies, specifies the grain size chosen for the volume copy when it was created.

**se\_copy**

Specifies if the copy is space-efficient.

**easy\_tier**

This value is set by the user and determines whether Easy Tier is permitted to manage the pool.

**Note:**

1. If **easy\_tier** is *on*, then **easy\_tier\_status** can take on any value.
2. if **easy\_tier** is *off*, then **easy\_tier\_status** is *measured* or *inactive* .

**easy\_tier\_status**

Which Easy Tier functions are active for the volume copy:

- *Active* : may move extents of this volume copy for performance (automatic data placement).
- *Measured*: statistics are being gathered for this volume copy, but no extents will be moved.
- *Inactive* : no Easy Tier function is active.

**tier** Which tier information is being reported:

- **generic\_ssd**
- **generic\_hdd**

**tier\_capacity**

The total MDisk capacity assigned to the volume in the tier.

**Note:** For space-efficient copies, the capacity by tier will be the real capacity.

**An invocation example**

```
lsvdiskcopy -delim :
```

**The resulting output**

```
vdisk_id:vdisk_name:copy_id:status:sync:primary:mdisk_grp_id:mdisk_grp_name:
capacity:type:se_copy:easy_tier:easy_tier_status
0:RAM_V2:0:online:yes:yes:2:RAM_MDG2:5.00GB:striped:yes:on:inactive
1:RAM_V3:0:online:yes:yes:2:RAM_MDG2:5.00GB:striped:no:on:inactive
2:RAM_V4:0:online:yes:yes:1:RAM_MDG3:5.00GB:striped:no:on:inactive
3:RAM_V5:0:online:yes:yes:2:RAM_MDG2:5.00GB:striped:yes:on:inactive
```

```
3:RAM_V5:1:online:yes:no:2:RAM_MDG2:5.00GB:striped:yes:on:inactive
4:RAM_V1:0:online:yes:yes:3:RAM_MDG1:5.00GB:striped:no:on:inactive
5:RAM_V6:0:online:yes:yes:0:RAM_MDG4:5.00GB:striped:yes:on:inactive
```

### An invocation example

```
lsvdiskcopy -copy 0 -delim : vv1
```

### The resulting output

```
vdisk_id:0
vdisk_name:vv1
capacity:16.00GB
copy_id:0
status:online
sync:yes
primary:yes
mdisk_grp:1
mdisk_grp name:mdisk_group_1
type:striped
mdisk_id:
mdisk_name:
fast_write_state:not_empty
used_capacity:2.00GB
real_capacity:8.00GB
free_capacity:6.00GB
overallocation:200
autoexpand:on
warning:25
grainsize:256
se_copy:yes
easy_tier:on
easy_tier_status:active
tier:generic_ssd
tier_capacity:64.00MB
tier:generic_hdd
tier_capacity:7.94GB
```

---

## lsvdiskdependentmaps

The **lsvdiskdependentmaps** command displays all FlashCopy mappings with target volumes that are dependent upon data held on the specified volume.

### Syntax

```
▶▶ lsvdiskdependentmaps [vdisk_id | vdisk_name] ▶▶
```

### Parameters

*vdisk\_id* | *vdisk\_name*

(Required) Specifies the name or ID of a volume.

### Description

The **lsvdiskdependentmaps** command displays FlashCopy mappings that have target volumes that are dependent upon data held on the specified *vdisk\_id* | *vdisk\_name*. This can be used to determine whether a FlashCopy mapping can be prepared. Issue the command for the target volume *vdisk\_id* | *vdisk\_name* of the FlashCopy mapping to be prepared. If no FlashCopy mappings are returned, the FlashCopy mapping can be prepared. Any FlashCopy mappings that are returned in the list must be stopped or be in the **idle\_or\_copied** state, before the new FlashCopy mapping can be prepared.

## A concise invocation example

```
lsvdiskdependentmaps -delim : 0
```

## The concise resulting output

```
id:name
2:fcmap2
5:fcmap5
```

---

## lsvdiskextent

The **lsvdiskextent** command lists the MDisk extents that are provided for the specified volumes.

## Syntax

```
▶▶ lsvdiskextent [-copy copy_id] [-nohdr] [-delim delimiter]
▶ [vdisk_name | vdisk_id]
```

## Parameters

### **-copy** *copy\_id*

(Optional) Displays a list of MDisks that are members of the specified volume copy.

### **-nohdr**

(Optional) By default, headings are displayed for each column of data in a concise style view, and for each item of data in a detailed style view. The **-nohdr** parameter suppresses the display of these headings.

**Note:** If there is no data to be displayed, headings are not displayed.

### **-delim** *delimiter*

(Optional) By default in a concise view, all columns of data are space-separated. The width of each column is set to the maximum possible width of each item of data. In a detailed view, each item of data has its own row, and if the headers are displayed, the data is separated from the header by a space. The **-delim** parameter overrides this behavior. Valid input for the **-delim** parameter is a one-byte character. If you enter **-delim :** on the command line, the colon character (:) separates all items of data in a concise view; for example, the spacing of columns does not occur. In a detailed view, the data is separated from its header by the specified delimiter.

*vdisk\_name* | *vdisk\_id*

(Required) Specifies one or more volume IDs or names.

## Description

The **lsvdiskextent** command displays a list of MDisk IDs and the number of extents that each MDisk provides to the specified volumes.

Each volume is constructed from one or more MDisks. To determine the relationship between a volume and its MDisks, issue the following command:

```
lsvdiskmember vdisk_name | vdisk_id
```

where *vdisk\_name* | *vdisk\_id* is the name or ID of the volume. This command displays a list of MDisk IDs that make up the volume.

To determine the number of extents that are provided by each MDisk, issue the following command:

```
lsdiskextent vdisk_name | vdisk_id
```

where *vdisk\_name* | *vdisk\_id* is the name or ID of the volume. This command displays a table of MDisk IDs and the corresponding number of extents that each MDisk provides as storage for the given volume.

To determine the relationship between MDisks and volumes, issue the following command for each MDisk:

```
lsdiskmember mdisk_name | mdisk_id
```

where *mdisk\_name* | *mdisk\_id* is the name or ID of the MDisk. This command displays a list of IDs that corresponds to the volumes that are using this MDisk.

To determine the relationship between MDisks and volumes, and the number of extents that are used by each volume, you must use the command-line interface. For each MDisk, issue the following command:

```
lsdiskextent mdisk_name | mdisk_id
```

where *mdisk\_name* | *mdisk\_id* is the name or ID of the MDisk. This command displays a table of volume IDs and the corresponding number of extents that are used by each volume.

### An invocation example

```
lsdiskextent -delim : vdisk0
```

### The resulting output

```
id:number_extents
0:0
```

---

## lsdiskfcmappcopies

The **lsdiskfcmappcopies** command displays a list of all FlashCopy mappings with a target volume containing a valid copy of the specified volume.

### Syntax

```
▶▶— lsdiskfcmappcopies — [-nohdr] [-delim — delimiter] [vdisk_name | vdisk_id] ▶▶
```

### Parameters

#### -nohdr

(Optional) By default, headings are displayed for each column of data in a concise style view, and for each item of data in a detailed style view. The **-nohdr** parameter suppresses the display of these headings.

**Note:** If there is no data to be displayed, headings are not displayed.

#### -delim *delimiter*

(Optional) By default in a concise view, all columns of data are space-separated. The width of each column is set to the maximum possible width of each item of data. In a detailed view, each item of data has its own row, and if the headers are displayed, the data is separated from the header by a space. The **-delim** parameter overrides this behavior. Valid input for the **-delim** parameter is a one-byte character. If you enter **-delim :** on the command line, the colon character (:) separates all

items of data in a concise view; for example, the spacing of columns does not occur. In a detailed view, the data is separated from its header by the specified delimiter.

*vdisk\_name* | *vdisk\_id*

(Required) Specifies the name or ID of the volume for which the FlashCopy mappings are displayed.

## Description

This command returns a list of the FlashCopy mappings that have a target volume with a valid copy of the specified volume. The target volumes of these mappings can be considered as candidate source volumes for mappings to restore from.

The mappings returned are in the copying, *idle\_copied*, or stopping state with 100% progress.

### An invocation example

```
lsvdiskfmapcopies -delim : 0
```

### The resulting output

```
id:name:status:progress:difference:start_time:target_vdisk_id:
target_vdisk_name:group_id:group_name
2:fcmap2:copying:80:10:060627083137:10:vdisk10::
5:fcmap5:idle_copied:100:20:060627073130:12:vdisk12:1:fccstgrp1
```

---

## lsvdiskfcmappings

The **lsvdiskfcmappings** command displays a list of FlashCopy mappings to which the volume belongs. A volume can be part of up to 256 FlashCopy mappings.

## Syntax

```
▶▶ lsvdiskfcmappings — [vdisk_name | vdisk_id] ▶▶
```

## Parameters

*vdisk\_name* | *vdisk\_id*

(Required) Specifies the name or ID of the volume for which a list of all FlashCopy mappings is required.

## Description

The **lsvdiskfcmappings** command returns a list of all FlashCopy mappings that the volume is a member of. The list is returned in no particular order.

### An invocation example

```
lsvdiskfcmappings -delim : vdisk2
```

### The resulting output

```
fc_id:fc_name
1:fcmap1
3:fcmap3
```

---

## lsvdiskhostmap

Use the **lsvdiskhostmap** command to list the volume to the host mapping. These hosts have the specified volume mapped to them; the volume is visible to these hosts.

## Syntax

```
lsvdiskhostmap [-nohdr] [-delim delimiter] [vdisk_id | vdisk_name]
```

## Parameters

### -nohdr

(Optional) By default, headings are displayed for each column of data in a concise style view, and for each item of data in a detailed style view. The **-nohdr** parameter suppresses the display of these headings.

**Note:** If there is no data to be displayed, headings are not displayed.

### -delim delimiter

(Optional) By default in a concise view, all columns of data are space-separated. The width of each column is set to the maximum possible width of each item of data. In a detailed view, each item of data has its own row, and if the headers are displayed, the data is separated from the header by a space. The **-delim** parameter overrides this behavior. Valid input for the **-delim** parameter is a one-byte character. If you enter `-delim :` on the command line, the colon character (`:`) separates all items of data in a concise view; for example, the spacing of columns does not occur. In a detailed view, the data is separated from its header by the specified delimiter.

*vdisk\_id | vdisk\_name*

(Required) Specifies the ID or name of the volume. The clustered system displays a list of all the hosts to which this volume is mapped and the SCSI ID by which the volume is mapped.

## Description

This command displays a list of host IDs and names. These hosts have the specified volume mapped to them; that is, the volume is visible to these hosts. The SCSI LUN ID is also displayed. The SCSI LUN ID is the ID by which the volume is recognized by the host.

**Determining the host that a volume is mapped to:** List the hosts that this volume is mapped to, by issuing the following command:

```
lsvdiskhostmap vdisk_id | vdisk_name
```

where *vdisk\_id | vdisk\_name* is the name or ID of the volume. A list is displayed. Look for the host name or ID to determine which host this volume is mapped to. If no data is displayed, the volume is not mapped to any hosts.

### An invocation example

```
lsvdiskhostmap bbb
```

### The resulting output

| id  | name | SCSI_id | host_id | host_name | vdisk_UID                         |
|-----|------|---------|---------|-----------|-----------------------------------|
| 200 | bbb  | 0       | 9       | mchost13  | 600507680197014B000000000000002A0 |

---

## lsvdisklba

The **lsvdisklba** command lists the volume and logical block address (LBA) for the specified MDisk LBA.

## Syntax

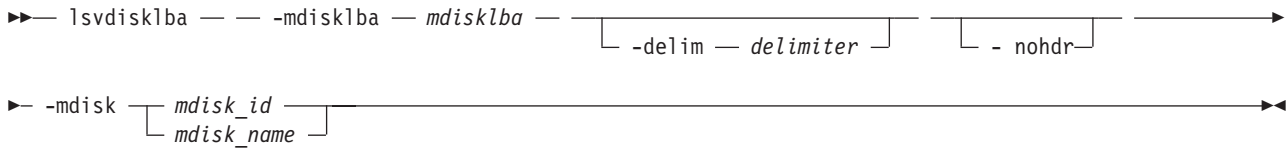

## Parameters

### **-mdisklba** *mdisklba*

(Required) Specifies the 64-bit hexadecimal LBA on the MDisk. The LBA must be specified in hex, with a 0x prefix.

### **-nohdr**

(Optional) By default, headings are displayed for each column of data in a concise style view, and for each item of data in a detailed style view. The **-nohdr** parameter suppresses the display of these headings.

**Note:** If there is no data to be displayed, headings are not displayed.

### **-delim** *delimiter*

(Optional) By default in a concise view, all columns of data are space separated. The width of each column is set to the maximum possible width of each item of data. In a detailed view, each item of data has its own row, and if the headers are displayed the data is separated from the header by a space. The **-delim** parameter overrides this behavior. Valid input for the **-delim** parameter is a one-byte character. If you enter **-delim :** on the command line, the colon character (:) separates all items of data in a concise view; for example, the spacing of columns does not occur. In a detailed view, the data is separated from its header by the specified delimiter.

### **-mdisk** *mdisk\_id* | *mdisk\_name*

(Required) Specifies the MDisk name or ID.

## Description

The **lsvdisklba** command returns the LBA of the volume that is associated with the MDisk LBA.

If applicable, the command also lists the range of LBAs on both the volume and MDisk that are mapped in the same extent, or for space-efficient disks, in the same grain.

Table 43 provides command output that depends on several variables.

Table 43. *lsvdisklba* command output scenarios

| Field              | Typical scenario | Quorum disk | Space-efficient metadata | Extent not allocated | Formatting extent | Extent allocated to space-efficient disk, LBA not used on space-efficient disk |
|--------------------|------------------|-------------|--------------------------|----------------------|-------------------|--------------------------------------------------------------------------------|
| <b>copy_id</b>     | yes              | no          | yes                      | no                   | yes               | yes                                                                            |
| <b>vdisk_id</b>    | yes              | no          | yes                      | no                   | yes               | yes                                                                            |
| <b>vdisk_name</b>  | yes              | no          | yes                      | no                   | yes               | yes                                                                            |
| <b>type</b>        | allocated        | metadata    | metadata                 | unallocated          | formatting        | unallocated                                                                    |
| <b>vdisk_lba</b>   | yes              | no          | no                       | no                   | no                | no                                                                             |
| <b>vdisk_start</b> | yes              | no          | no                       | no                   | no                | no                                                                             |
| <b>vdisk_end</b>   | yes              | no          | no                       | no                   | no                | no                                                                             |



Table 43. `lsvdisklba` command output scenarios (continued)

| Field                    | Typical scenario | Quorum disk | Space-efficient metadata | Extent not allocated | Formatting extent | Extent allocated to space-efficient disk, LBA not used on space-efficient disk |
|--------------------------|------------------|-------------|--------------------------|----------------------|-------------------|--------------------------------------------------------------------------------|
| <code>mdisk_start</code> | yes              | yes         | yes                      | yes                  | yes               | yes                                                                            |
| <code>mdisk_end</code>   | yes              | yes         | yes                      | yes                  | yes               | yes                                                                            |

### An invocation example

```
lsvdisklba -mdisk 1 -mdisklba 0x0
```

### The resulting output

```
vdisk_id
vdisk_name
copy_id
type metadata
vdisk_lba 0x00090000
vdisk_start
vdisk_end
mdisk_start 0x00000000
mdisk_end 0x1FFFFFFFFF
```

---

## lsvdiskmember

The `lsvdiskmember` command displays a list of MDisks that are members of the specified volume.

### Syntax

```

▶▶▶ lsvdiskmember -- [-copy copy_id] [-nohdr] [-delim delimiter]
▶ [vdisk_id | vdisk_name]

```

### Parameters

#### **-copy** *copy\_id*

(Optional) Displays a list of MDisks that are members of the specified volume copy.

#### **-nohdr**

(Optional) By default, headings are displayed for each column of data in a concise style view, and for each item of data in a detailed style view. The **-nohdr** parameter suppresses the display of these headings.

**Note:** If there is no data to be displayed, headings are not displayed.

#### **-delim** *delimiter*

(Optional) By default in a concise view, all columns of data are space-separated. The width of each column is set to the maximum possible width of each item of data. In a detailed view, each item of data has its own row, and if the headers are displayed, the data is separated from the header by a space. The **-delim** parameter overrides this behavior. Valid input for the **-delim** parameter is a one-byte character. If you enter `-delim :` on the command line, the colon character (`:`) separates all items of data in a concise view; for example, the spacing of columns does not occur. In a detailed view, the data is separated from its header by the specified delimiter.

*vdisk\_id* | *vdisk\_name*

(Required) Displays a list of MDisks that are members of the specified volume.

## Description

This command displays a list of managed disks, which provide extents that make up the volume that is specified by the ID.

Every volume is constructed from one or more MDisks. At times, you might have to determine the relationship between the two objects. The following procedure allows you to determine the relationships.

If you use the **lsmdiskmember** command, the concise view displays a list of volumes. These are the volumes that are using extents on the managed disk that is specified by the ID. The list displays the members of the respective object and is independent of the state of the individual members; that is, if they are in offline state, they are still displayed.

To determine the relationship between volumes and MDisks, issue the following command:

```
lsdiskmember vdisk_id | vdisk_name
```

where *vdisk\_id* | *vdisk\_name* is the name or ID of the volume. This displays a list of IDs that correspond to the MDisks that make up the volume.

To determine the relationship between volumes and MDisks, and the number of extents that are provided by each MDisk, you must use the command-line interface. Issue the following command:

```
lsdiskextent vdisk_id | vdisk_name
```

where *vdisk\_id* | *vdisk\_name* is the name or ID of the volume. This displays a table of MDisk IDs and the corresponding number of extents that each MDisk provides as storage for the specified volume.

To determine the relationship between MDisks and volumes, issue the following command:

```
lsmdiskmember mdisk_id | mdisk_name
```

where *mdisk\_id* | *mdisk\_name* is the name or ID of the MDisk. This displays a list of IDs that correspond to the volumes that are using this MDisk.

To determine the relationship between MDisks and volumes, and the number of extents that are used by each volume, you must use the command-line interface. For a specified MDisk, issue the following command:

```
lsmdiskextent mdisk_id | mdisk_name
```

where *mdisk\_id* | *mdisk\_name* is the name or ID of the MDisk. This displays a table of volume IDs and the corresponding number of extents that are used by each volume.

## An invocation example

```
lsdiskmember 1
```

## The resulting output

```
id
2
```

---

## lsvdiskprogress

The `lsvdiskprogress` command tracks the progress during new volume formatting.

### Syntax

```
lsvdiskprogress [-nohdr] [-delim delimiter] [vdisk_id | vdisk_name]
```

### Parameters

#### **-nohdr**

(Optional) By default, headings are displayed for each column of data in a concise style view, and for each item of data in a detailed style view. The **-nohdr** parameter suppresses the display of these headings.

**Note:** If there is no data to be displayed, headings are not displayed.

#### **-delim delimiter**

(Optional) By default in a concise view, all columns of data are space-separated. The width of each column is set to the maximum possible width of each item of data. In a detailed view, each item of data has its own row, and if the headers are displayed, the data is separated from the header by a space. The **-delim** parameter overrides this behavior. Valid input for the **-delim** parameter is a one-byte character. If you enter `-delim :` on the command line, the colon character (`:`) separates all items of data in a concise view; for example, the spacing of columns does not occur. In a detailed view, the data is separated from its header by a colon character.

#### *vdisk\_id | vdisk\_name*

(Optional) Specifies the volume ID or name. If you do not specify this parameter, the progress of all volumes currently being formatted is displayed.

### Description

This command displays the progress of the format of a new volume as a completed percentage. If the volume has multiple copies, the command reports the average progress of the format.

#### An invocation example

```
lsvdiskprogress -delim : 0
```

#### The resulting output

```
id:progress
0:58
```

---

## lsvdisksyncprogress

The `lsvdisksyncprogress` command displays the progress of volume copy synchronization.

### Syntax

```
lsvdisksyncprogress [-copy id] [vdisk_name | vdisk_id]
```

## Parameters

### **-copy id**

(Optional) Specifies the volume copy ID to list synchronization progress for. You must also specify a *vdisk\_name* | *vdisk\_id* value. If you do not specify this parameter, progress is displayed for all copies.

### *vdisk\_name* | *vdisk\_id*

(Optional) Specifies the volume name or ID to list synchronization progress for.

## Description

The **lsvdisksyncprogress** command displays the progress of volume copy synchronization. To display the volume copies that require synchronization, specify the command with no parameters. Estimated completion time is in the YYMMDDHHMMSS format. The command displays progress for the following types of volumes:

- A synchronized copy displays a progress of 100 and a blank estimated completion time.
- An offline copy displays a blank estimated completion time, and a gradually decreasing progress if the volume is being written to.
- Nonmirrored volumes are displayed as a single copy with a progress of 100, and a blank estimated completion time.

The **lsvdisksyncprogress** command also displays the progress of a mirrored volume synchronization. After you create a mirrored volume using the **mkvdisk** or **addvdiskcopy** command, you can use the command to monitor the progress of the synchronization.

### An invocation example

```
lsvdisksyncprogress
```

### The resulting output

| <i>vdisk_id</i> | <i>vdisk_name</i> | <i>copy_id</i> | <i>progress</i> | <i>estimated_completion_time</i> |
|-----------------|-------------------|----------------|-----------------|----------------------------------|
| 0               | vdisk0            | 0              | 100             |                                  |
| 0               | vdisk0            | 1              | 50              | 070301150000                     |
| 3               | vdisk3            | 0              | 72              | 070301132225                     |
| 3               | vdisk3            | 1              | 100             |                                  |
| 4               | vdisk4            | 0              | 22              | 070301160000                     |
| 4               | vdisk4            | 1              | 100             |                                  |
| 8               | vdisk8            | 0              | 100             |                                  |
| 8               | vdisk8            | 1              | 33              |                                  |

### An invocation example

```
lsvdisksyncprogress vdisk0
```

### The resulting output

| <i>vdisk_id</i> | <i>vdisk_name</i> | <i>copy_id</i> | <i>progress</i> | <i>estimated_completion_time</i> |
|-----------------|-------------------|----------------|-----------------|----------------------------------|
| 0               | vdisk0            | 0              | 100             |                                  |
| 0               | vdisk0            | 1              | 50              | 070301150000                     |

---

## Isdependentvdisks

Use the **Isdependentvdisks** command to view which volumes will go offline if you remove a specific piece of hardware from the system.

## Syntax

```
▶▶ Isdependentvdisks — [-node —node_id_or_name—] ▶▶
```

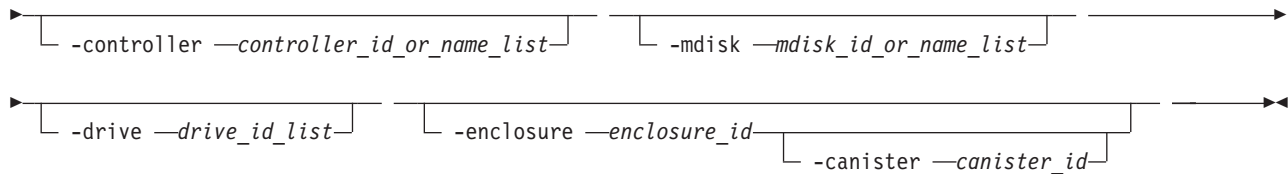

## Parameters

### **-node**

(Optional) Specifies the node for which volume dependency is required.

### **-controller**

(Optional) Specifies the controllers for which volume dependency is required.

### **-mdisk**

(Optional) Specifies the MDisks for which volume dependency is required.

### **-drive**

(Optional) Specifies the drives for which volume dependency is required. There is a maximum of 128 entries.

### **-enclosure**

(Optional) Specifies the enclosure for which volume dependency is required. You can remove a control enclosure without affecting your other data.

### **-canister**

(Optional) Specifies an enclosure canister if **-enclosure**. This option is not valid for any other type.

**Note:** Possible values are 1 and 2.

## Description

Use this command to view which volumes will go offline if you remove a specific piece of hardware from the system. Use this command before you perform maintenance, to determine which volumes will be affected.

### An invocation example

```
lsdependentvdisks -delim : -drive 0:1
```

### The resulting output

```
vdisk_id:vdisk_name
4:vdisk4
5:vdisk5
```

**Note:** This means that if drives 0 and 1 are removed, then volume vdisk4 and volume vdisk5 will go offline.

---

## Issasfabric

Use the **Issasfabric** command to see which canisters are visible to a node, and the order of these canisters.

## Syntax

```
Issasfabric
```

## Description

Use this command to see which canisters are visible to a node, and the order of these canisters. Table 44 describes possible outputs.

Table 44. *Issasfabric* output

| Attribute             | Description                                                                                             |
|-----------------------|---------------------------------------------------------------------------------------------------------|
| enclosure_id          | The identity of the enclosure the strand goes to.                                                       |
| canister_id           | The canister in the enclosure that the strand goes to.                                                  |
| canister_port_id      | The canister port that the strand goes to.                                                              |
| control_enclosure_id  | The identity of the enclosure the strand comes from.                                                    |
| node_canister_id      | The identity of the canister the strand comes from.                                                     |
| node_canister_port_id | The node canister port the strand is from. This should be the same as the chain ID.                     |
| position              | The position in the strand or chain.                                                                    |
| IO_group_id           | The I/O group the strand belongs to. This should be the same as the enclosure IO group.                 |
| IO_group_name         | The I/O group the strand belongs to. This should be the same as the enclosure IO group.                 |
| node_id               | The identity of the node that the strand is from. This is the same physical object as the node_canister |
| node_name             | The name of the node that the strand is from. This is the same physical object as the node_canister.    |

**An invocation example with three enclosures: Enclosure 1 is the control enclosure, Enclosure 2 is on chain 1 (node canister port 1) using canister port 1 as its connector, and Enclosure 3 is on chain 2 (node canister port 2) using canister port 2 as its connector**

```
lssasfabric
```

### The resulting output

**Note:** In this guide, the following output is split into two parts. This is for illustrative purposes; the output will not appear in two parts when you run this command.

#### Output

```
enclosure_id canister_id canister_port_id control_enclosure_id node_canister_id
 1 1 1 1 1
 1 2 1 1 2
 2 1 1 1 1
 2 2 1 1 2
 3 1 2 1 1
 3 2 2 1 2
```

#### Output, continued

```
node_canister_port_id position IO_group_id IO_group_name node_id node_name
 2 0 0 io_grp0 1 node1
 2 0 0 io_grp0 2 node2
 1 1 0 io_grp0 1 node1
 1 1 0 io_grp0 2 node2
 2 1 0 io_grp0 1 node1
 2 1 0 io_grp0 2 node2
```

---

## showtimezone

Use the **showtimezone** command to display the current time zone settings for the cluster.

### Syntax

```
▶▶ showtimezone — [-nohdr] [-delim — delimiter] ▶▶
```

### Parameters

#### **-nohdr**

(Optional) By default, headings are displayed for each column of data in a concise style view, and for each item of data in a detailed style view. The **-nohdr** parameter suppresses the display of these headings.

**Note:** If there is no data to be displayed, headings are not displayed.

#### **-delim *delimiter***

(Optional) By default in a concise view, all columns of data are space-separated. The width of each column is set to the maximum possible width of each item of data. In a detailed view, each item of data has its own row, and if the headers are displayed, the data is separated from the header by a space. The **-delim** parameter overrides this behavior. Valid input for the **-delim** parameter is a one-byte character. If you enter `-delim :` on the command line, the colon character (`:`) separates all items of data in a concise view; for example, the spacing of columns does not occur. In a detailed view, the data is separated from its header by the specified character.

### Description

This command displays a single time zone and its associated ID. This is the current time zone setting for the cluster. A list of available time-zones can be viewed by running the **lstimezones** command. The time zone can be changed by running the **settimezone** command.

#### An invocation example

```
showtimezone -delim :
```

#### The resulting output

```
id:timezone
522:UTC
```





---

## Chapter 18. livedump commands

Livedump commands are used to manage the node livedumps.

The livedump commands include:

### **lslivedump**

This command queries the livedump state of a node.

### **preplivedump**

This command reserves the system resources that are required for a livedump.

### **triggerlivedump**

This command captures the metadata that you want to dump, and writes the dump file to the internal disk on the node.

### **cancellivedump**

This command cancels a livedump.

---

## **cancellivedump**

Use the **cancellivedump** command to cancel a live dump.

### **Syntax**

```
▶▶ cancellivedump -- node_name | node_id ▶▶
```

### **Parameters**

*node\_name* | *node\_id*

Identifies the node name or ID.

### **Description**

Use this command if you issue a **preplivedump** command, but then decide not to issue a **triggerlivedump** command. This releases the resources you allocated for the livedump. This event is located in the node trace (.trc) file. For this command to succeed, the node must be in a livedump *prepared* state.

---

## **lslivedump**

The **lslivedump** command queries the livedump state of a node.

### **Syntax**

```
▶▶ lslivedump -- node_name | node_id ▶▶
```

### **Parameters**

*node\_name* | *node\_id*

Identifies the node name or ID.

## Description

You can issue this command repeatedly to determine if a livedump is in progress for the node. The following table describes the possible outputs:

Table 45. *lslivedump* outputs

| Attribute | Description                        |
|-----------|------------------------------------|
| inactive  | The node has no livedump activity. |
| prepared  | The node is ready to be triggered. |
| dumping   | The node is writing the dump file. |

---

## prelivedump

The **prelivedump** command reserves the system resources that are required for livedump.

### Syntax

```
prelivedump -- [node_name | node_id]
```

### Parameters

*node\_name* | *node\_id*  
Identifies the node name or ID.

## Description

You can prepare more than one node for livedump at a time by issuing the **prelivedump** command consecutively. However, you can only trigger one livedump at a time, with an automatic lag time of 30 seconds between each trigger event. This helps maintain node stability.

You can issue multiple **prelivedump** commands on the same node; however, only a **prelivedump** command followed by a **triggerlivedump** command results in output.

Because the livedump resource allocation can take time to execute, you can issue this command to prepare the livedump but trigger it at a later time. This command times out after 60 seconds. The **prelivedump** event is located in the node trace (.trc) file.

---

## triggerlivedump

The **triggerlivedump** command captures the metadata that you want to dump, and writes the dump file to the internal disk on the node.

### Syntax

```
triggerlivedump -- [node_name | node_id]
```

### Parameters

*node\_name* | *node\_id*  
Identifies the node name or ID.

## | **Description**

| You can issue this command to trigger a **livedump** command. Only one **triggerlivedump** action can be in progress at one time, with an automatic lag time of 30 seconds between each trigger event. The node must have a livedump state of *prepared* for this command to succeed. Output is recorded in the node trace (.trc) file.

| After you issue the **triggerlivedump** command, the command captures data and returns you to the CLI so that you can issue additional commands. While you issue additional commands, the livedump disk file is written to the disk in the background, and the livedump state shows as *dumping*. After the write is complete, the state shows as *inactive*.



---

## Chapter 19. Managed disk commands

The following commands enable you to work with managed disk options with the SAN Volume Controller.

If the clustered system (system) detects an MDisk, it automatically adds it to the list of known MDisks. If you subsequently delete the RAID that corresponds to the MDisk, the system only deletes the MDisk from the list if the MDisk is offline and it has a mode of unmanaged (it does not belong to an MDisk group).

---

### applymdisksoftware (Discontinued)

**Attention:** The **applymdisksoftware** command has been discontinued. Use the **applydrivesoftware** command to upgrade drives.

---

### chmdisk

Use the **chmdisk** command to modify the name of a managed disk (MDisk).

#### Syntax

```
▶▶ chmdisk — [-name — new_name_arg] [-tier [generic_ssd | generic_hdd]] [mdisk_id | mdisk_name] ▶▶
```

#### Parameters

**-name** *new\_name\_arg*

Specifies the new name to be applied to the managed disk.

**-tier**

Specifies the new tier of the MDisk.

*mdisk\_id* | *mdisk\_name*

(Required) Specifies the ID or name of the managed disk to modify.

#### Description

This command modifies the attributes of a managed disk.

#### An invocation example

```
chmdisk -tier generic_hdd mdisk13
```

#### The resulting output

No feedback

---

### chquorum

Use the **chquorum** command to change the quorum association.

## Syntax

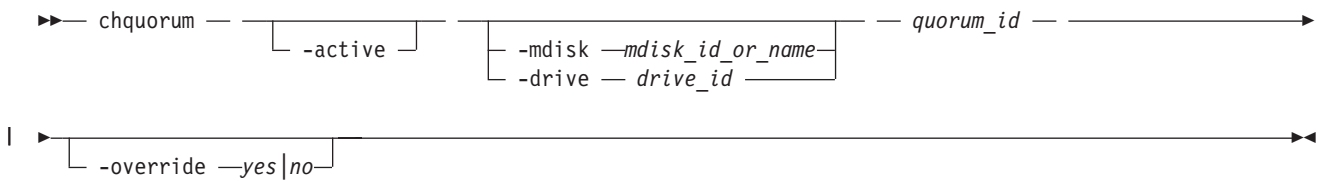

## Parameters

### **-active**

(Optional) Makes the specified quorum ID the active one. The **active** parameter must be used if neither the **mdisk** nor the **drive** parameters are specified.

### **-mdisk** *mdisk\_id\_or\_name* | **-drive** *drive\_id*

(Optional) Specifies the MDisk or drive to be this quorum ID.

**Note:** SAN Volume Controller uses MDisks only.

### *quorum\_id*

(Required) Specifies which quorum ID to change. Permitted values are values are 0, 1, and 2.

### **-override** *yes|no*

Enables the automatic quorum selection to be overridden. In this state, the quorum disk is only moved if the resources are offline. Do not use this parameter unless a specific quorum disk is required for the configuration.

## Description

Use the **chquorum** command to change the quorum association. To identify the drive or MDisk that is the current active quorum disk, use the **lsquorum** command.

**Note:** SAN Volume Controller uses MDisks only.

**Attention:** Only assign quorum to drives in the control enclosure or to external MDisks. Some maintenance procedures require that quorum is moved temporarily to expansion enclosures. Once that procedure is complete, return the quorum drives to the control enclosure.

The **chquorum** command is not synchronous, but usually takes only a few seconds to complete. In some situations it can take several minutes.

The clustered system (system) uses the quorum disk or drive as a tie breaker when exactly half of the nodes that were previously a member of the system is present.

The use of a quorum disk or drive allows the system to manage a SAN fault that splits the system exactly in half. One half of the system continues to operate and the other half stops until SAN connectivity is restored.

There is only one quorum disk or drive; however, the system uses three as quorum candidates. The system selects the actual quorum disk or drive from the pool of quorum candidates. The quorum candidates also hold a copy of important system metadata. Just over 256 MB is reserved for this purpose on each quorum candidate disk. When using an MDisk as quorum disk, this space is allocated from the storage pool. The number of extents required depends on the extent size for the managed disk group containing the MDisk. Table 46 on page 319 provides the number of extents reserved for quorum use by extent size.

Table 46. Number of extents reserved by extent size

| Extent size (MB) | Number of extents reserved for quorum use |
|------------------|-------------------------------------------|
| 16               | 17                                        |
| 32               | 9                                         |
| 64               | 5                                         |
| 128              | 3                                         |
| 256              | 2                                         |
| 512              | 1                                         |
| 1024             | 1                                         |
| 2048             | 1                                         |
| 4096             | 1                                         |
| 8192             | 1                                         |

When you issue this command, the MDisk or drive that currently is assigned the quorum index number is set to a nonquorum disk. The system automatically assigns quorum indexes.

You can set the active quorum disk or drive with the **active** parameter. This can be useful in a split-site system configuration to ensure that the most highly-available quorum disk or drive is used.

#### An invocation example

```
chquorum -mdisk 45 2
```

#### The resulting output

No feedback

---

## dumpallmdiskbadblocks

The **dumpallmdiskbadblocks** command dumps bad block counts to a dump file for use by fix procedures and the satask **snap** command.

### Syntax

▶▶— dumpallmdiskbadblocks —————▶▶

### Parameters

None

### Description

Use the **dumpallmdiskbadblocks** command to dump bad block counts to a readable ASCII dump file for use by fix procedures and the satask **snap** command. The output contains bad blocks for which an error log has been raised.

Use **lsdumps -prefix /dumps/mdisk** to list the output files. Use **cleardumps -prefix /dumps/mdisk** to clear the output files.

The maximum number of dump files is 20.

#### An invocation example

dumpallmdiskbadblocks

### The resulting output if MDisk 2 and MDisk 5 have bad blocks

Cluster name: my\_cluster  
Timestamp of dump: Fri Oct 31 11:27:33 2009 UTC

Mdisk id: 2  
Mdisk name: mdisk2  
Number of bad blocks: 4

Mdisk id: 5  
Mdisk name: mdisk 5  
Number of bad blocks: 1

Total mdisks with bad blocks: 2  
Total number of bad blocks: 5

### The resulting output if the MDisks have no bad blocks

Cluster name: my\_cluster  
Timestamp of dump: Fri Oct 31 11:27:33 2009 UTC

Total mdisks with bad blocks: 0  
Total number of bad blocks: 0

---

## dumpmdiskbadblocks

The **dumpmdiskbadblocks** command writes the bad block counts and locations that are on a specified MDisk to a dump file for use by fix procedures.

### Syntax

▶▶ — dumpmdiskbadblocks — — *object\_id\_or\_name* —————▶▶

### Parameters

*object\_id\_or\_name*

(Required) Specifies the MDisk for which you need to dump the bad block record table.

### Description

Use the **dumpmdiskbadblocks** command to write the bad block counts and locations that are on a specified MDisk to a readable ASCII dump file for use by fix procedures. The output consists of bad blocks for which an error log has been raised.

Use **lsdumps -prefix /dumps/mdisk** to list the output files. Use **cleardumps -prefix /dumps/mdisk** to clear the output files.

The reported error log sequence numbers correspond to the first error seen in the bad block record, which is a 512-block region.

- If there are multiple error logs in the same region, the earliest error sequence is used.
- If there are error logs of different types in the same region, error sequence numbers for killsectors take precedence.
- If a range of bad blocks runs across record boundaries, the sequence number corresponding to the last record is used.

The maximum number of dump files is 20.



### An invocation example

```
dumpdiskbadblocks 3
```

### The resulting output if the MDisk has bad blocks

```
Cluster name: my_cluster
Timestamp of dump: Fri Oct 31 11:27:33 2009 UTC
```

```
Mdisk id: 3
Mdisk name: mdisk3
Number of bad blocks: 6
```

```
Start LBA: 0x1234123412341234
Length: 2
Error log sequence number: 1
```

```
Start LBA: 0x5678567812341234
Length: 4
Error log sequence number: 2
```

### The resulting output if the MDisk has no bad blocks

```
Cluster name: my_cluster
Timestamp of dump: Fri Oct 31 11:27:33 2009 UTC
```

```
Mdisk id: 3
Mdisk name: mdisk3
Number of bad blocks: 0
```

---

## includemdisk

Use the **includemdisk** command to include a disk that has been excluded by the cluster.

### Syntax

```
▶▶ — includemdisk — [mdisk_id | mdisk_name] —▶▶
```

### Parameters

*mdisk\_id* | *mdisk\_name*

(Required) Specifies the ID or name of the managed disk to add back into the cluster.

### Description

The specified managed disk is included in the cluster.

You might exclude a disk from the cluster because of multiple I/O failures. These failures might be caused by noisy links. Once a fabric-related problem has been fixed, the excluded disk can be added back into the cluster.

Running this command against an MDisk might change its state, whether the state is reported as excluded.

**Note:** If an MDisk is in the excluded state, is offline, and does not belong to an MDisk group, issuing an include command for this MDisk results in the MDisk record being deleted from the cluster.

### An invocation example

```
includemdisk mdisk5
```

## The resulting output

No feedback

---

## setquorum (Deprecated)

**Attention:** The **svctask setquorum** command is deprecated. Use the **svctask chquorum** command to change the quorum association.

---

## triggerdiskdump (Discontinued)

**Attention:** The **triggerdiskdump** command is discontinued. Use the **triggerdrivedump** command to collect support data from a disk drive.

---

## Chapter 20. Managed disk group commands

The following commands enable you to work with managed disk group options with the SAN Volume Controller.

---

### addmdisk

The **addmdisk** command adds one or more managed disks to an existing managed disk group.

#### Syntax

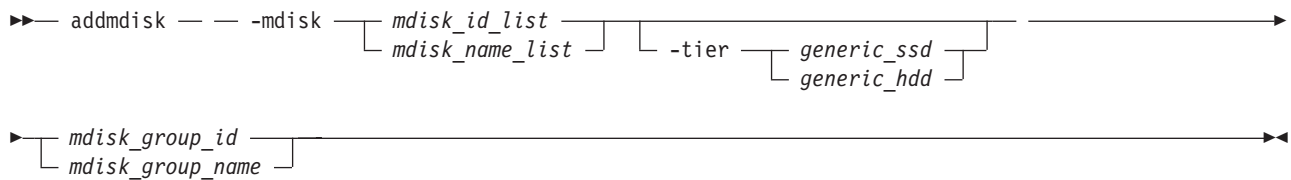

#### Parameters

**-mdisk** *mdisk\_id\_list* | *mdisk\_name\_list*

(Required) Specifies one or more managed disk IDs or names to add to the group.

*mdisk\_group\_id* | *mdisk\_group\_name*

(Required) Specifies the ID or name of the managed disk group to add the disks to. When an MDisk is added, the warning threshold for the MDisk group is automatically scaled.

**-tier**

Specifies the tier of the MDisk or MDisks being added.

Unless otherwise specified, the current tier value associated with the MDisk will be retained. The default value for a newly discovered unmanaged MDisk is *generic\_hdd*. You can change this value by using the **chmdisk** command.

External SSDs cannot be detected automatically. If you want external SSDs to be known by the system, you must either specify the tier when adding the managed disk to the mdisk group, or use the **chmdisk** command.

#### Description

This command adds the managed disks that you specify to the group. The disks can be specified in terms of the managed disk ID or the managed disk name.

The managed disks must be in unmanaged mode. Disks that already belong to a group cannot be added to another group until they have been deleted from their current group. You can delete a managed disk from a group under the following circumstances:

- If the managed disk does not contain any extents in use by a virtual disk
- If you can first migrate the extents in use onto other free extents within the group.

#### An invocation example

```
addmdisk -mdisk mdisk13:mdisk14 -tier generic_ssd Group0
```

#### The resulting output

No feedback

---

## chmdiskgrp

Use the **chmdiskgrp** command to modify the name that is assigned to a managed disk (MDisk) group or to set the warning threshold for the MDisk group.

### Syntax

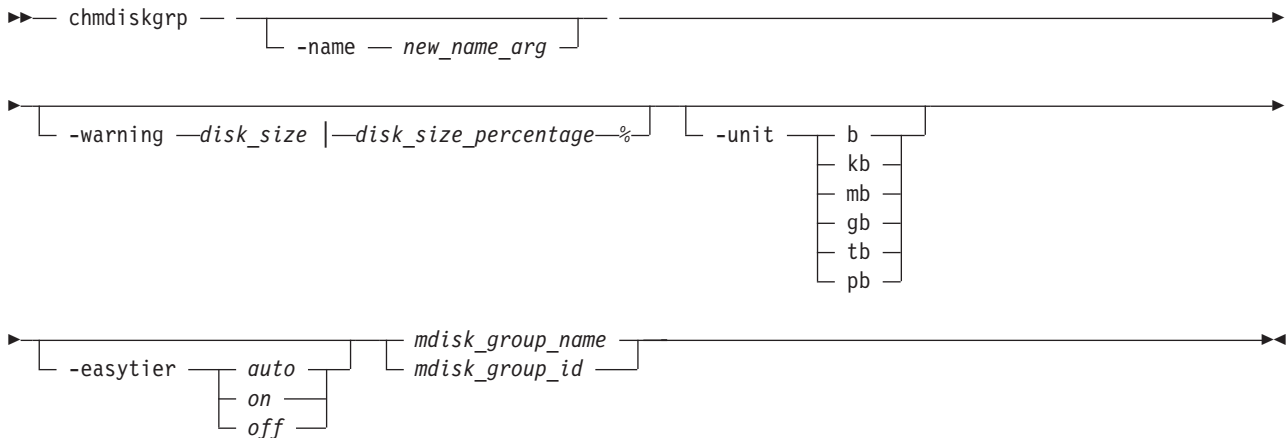

### Parameters

**-name** *new\_name\_arg*

(Optional) Specifies the new name of the managed disk group.

**-warning** *disk\_size* | *disk\_size\_percentage%*

(Optional) Sets a threshold at which a warning is generated. The warning is generated the first time that the threshold is exceeded by the used-disk capacity in the MDisk group. You can specify a *disk\_size* integer, which defaults to megabytes (MB) unless the **-unit** parameter is specified; or you can specify a *disk\_size%*, which is a percentage of the MDisk group size. To disable warnings, specify **0** or **0%**.

**-unit** **b** | **kb** | **mb** | **gb** | **tb** | **pb**

(Optional) Specifies the data units for the **-warning** parameter.

*mdisk\_group\_id* | *mdisk\_group\_name*

(Required) Specifies the ID or name of the managed disk group to modify.

**-easytier**

Specifies if the Easy Tier function is on or off for this MDisk group, or if it is automatically determined.

**Note:** **-easytier** must be followed by one of the following:

- If **-easytier** is set to *auto*, SAN Volume Controller will automatically enable Easy Tier functions when the MDisk group contains MDisks from more than one tier, and will disable automatic data placement when the MDisk group contains MDisks from only one tier.
- If **-easytier** is set to *on*, then Easy Tier functions will be active.
- If **-easytier** is set to *off*, then Easy Tier functions will be inactive.

### Description

This command modifies the name, or label, assigned to a given managed disk group. Subsequently, you can use the new name to refer to the managed disk group.

The command can also be used to set the warning threshold for the managed disk group. The warning threshold is the threshold at which a warning is generated when it is exceeded by the used-disk capacity in the MDisk group.

### An invocation example

```
chmdiskgrp -name testmdiskgrp -easytier on Group0
```

### The resulting output

No feedback

## mkmdiskgrp

The **mkmdiskgrp** command creates a new managed disk group (storage pool).

### Syntax

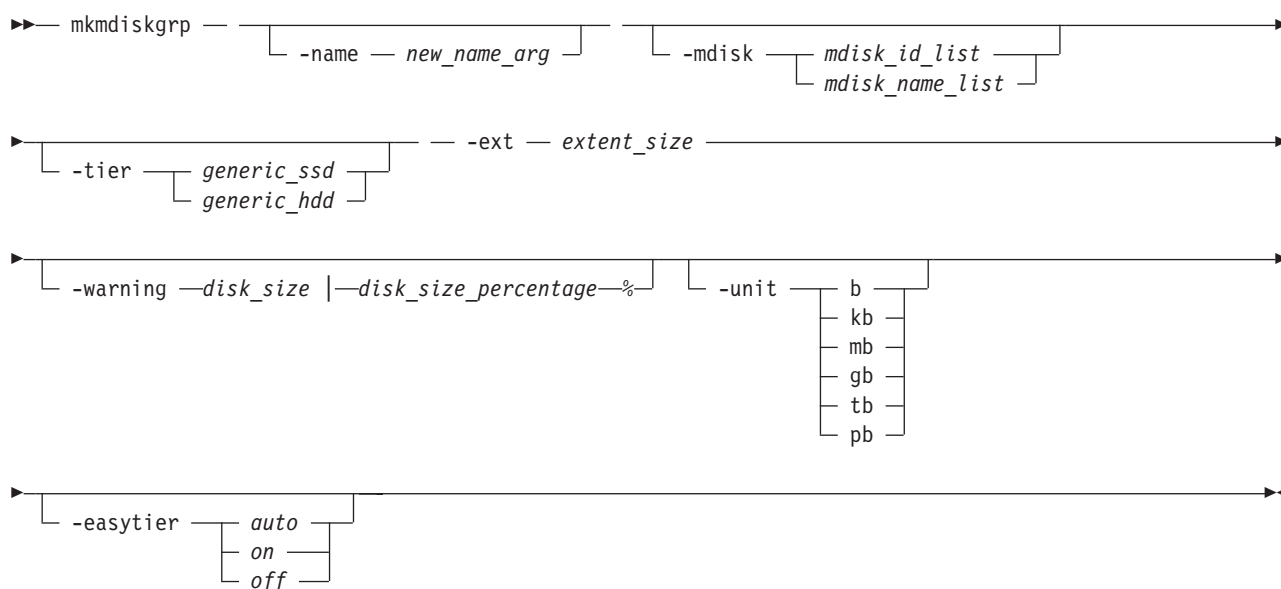

### Parameters

**-name** *new\_name\_arg*

(Optional) Specifies a name to assign to the new group.

**-mdisk** *mdisk\_id\_list* | *mdisk\_name\_list*

(Optional) Specifies a colon-separated list of managed disk IDs or names to add to the group. You can create an empty MDisk group by not specifying the **-mdisk** parameter.

**-ext** *extent\_size*

(Required) Specifies the size of the extents for this group in MB. The **ext** parameter must have one of the following values: **16**, **32**, **64**, **128**, **256**, **512**, **1024**, **2048**, **4096**, or **8192** (MB).

**-warning** *disk\_size* | *disk\_size\_percentage%*

(Optional) Generates a warning when the used disk capacity in the MDisk group first exceeds the specified threshold. You can specify a *disk\_size* integer, which defaults to megabytes (MB) unless the **-unit** parameter is specified; or you can specify a *disk\_size%*, which is a percentage of the MDisk group size. To disable warnings, specify **0** or **0%**. The default value is **0**.

**-unit** **b** | **kb** | **mb** | **gb** | **tb** | **pb**

(Optional) Specifies the data units for the **-warning** parameter.

**-tier**

Specifies the tier of the MDisk or MDisks being added. If you do not specify a tier, the current tier value of the MDisk will be retained. The default value for an external MDisk is `generic_hdd`.

**-easytier**

Specifies if the Easy Tier function is active for this MDisk group, or if it is automatically determined. *Auto* is the default value.

**Note:**

- If **-easytier** is set to *auto*, SAN Volume Controller will automatically enable Easy Tier functions when the MDisk group contains MDisk from more than one tier, and will disable Easy Tier functions when the MDisk group contains MDisk from only one tier.
- If **-easytier** is set to *on*, then Easy Tier functions will be active.
- If **-easytier** is set to *off*, then Easy Tier functions will be inactive.

## Description

The **mkmdiskgrp** command creates a new managed disk group and assigns the group name if specified. The ID of the new group is returned if the command is successful. Managed disk groups are collections of managed disks. Each group is divided into chunks, called extents, which are used to create VDIs(volumes).

Optionally, you can specify a list of managed disks that will be added to this group. These managed disks cannot belong to another group, and they must have a mode of unmanaged. Use the **lsmdiskcandidate** command to get a list of suitable candidates. If **-tier** is specified, it will apply to all of the MDisks.

Each managed disk that is a member of this group is split into extents. The storage that is available on these disks is added to a pool of extents that is available in this group. When a virtual disk is created from this group, free extents from the pool are used, in accordance with the policy used when the virtual disk was first created.

All managed disks subsequently added to this group are split into extents of the same size as the size that is assigned to the group.

When choosing an extent size, take into account the amount of storage you want to virtualize in this group. The system maintains a mapping of extents between virtual disks and managed disks. The cluster can only manage a finite number of extents (4 194 304). One cluster can virtualize the following number of extents:

- 64 TB – if all managed disk groups have extent sizes of 16 MB.
- 32 PB – if all managed disk groups have extent sizes of 8192 MB.

**Important:** The extent size for the MDisk group can also limit VDisk size. Consider the maximum VDisk size you want to use when creating MDisk groups. Refer to the information on creating MDisk groups for a comparison of the maximum VDisk capacity for each extent size. The maximum is different for space-efficient Vdisks (thin-provisioned volumes).

**Note:** When an image mode VDisk is created, the MDisk group increases in capacity by the size of the image mode VDisk (not the MDisk capacity), because the image mode VDisk might be smaller than the MDisk itself. If an extent is migrated from the image mode VDisk or MDisk to elsewhere in the group, the VDisk becomes a striped VDisk (no longer image mode). At this point the available capacity might increase, because the extra capacity available on the MDisk (for example, the capacity that was not part of the image mode VDisk) becomes available.

### An invocation example

```
mkmdiskgrp -mdisk mdisk13 -tier generic_hdd -easytier off -ext 512
```

### The resulting output

```
MDisk Group, id [1], successfully created
```

### An invocation example

```
mkmdiskgrp -mdisk mdisk0:mdisk1:mdisk2:mdisk3 -ext 32
```

### The resulting output

```
MDisk Group, id [0], successfully created
```

---

## rmmdisk

The **rmmdisk** command deletes a managed disk (MDisk) from a managed disk group.

### Syntax

```
▶▶ rmmdisk — — -mdisk [mdisk_id_list | mdisk_name_list] [-force] [mdisk_group_id | mdisk_group_name] ▶▶
```

### Parameters

**-mdisk** *mdisk\_id\_list* | *mdisk\_name\_list*

(Required) Specifies one or more managed disk IDs or names to delete from the group.

**-force**

(Optional) Migrates data on the specified disks to other disks in the group. The command completes asynchronously if **-force** is specified.

*mdisk\_group\_id* | *mdisk\_group\_name*

(Required) Specifies the ID or name of the managed disk group to delete the disks from. The warning threshold for an MDisk group is automatically scaled when MDisks are deleted.

### Description

This command attempts to remove the managed disk or disks from the group.

Deleting a managed disk from a group can only be done if the managed disk does not contain any extents in use by a virtual disk. If there are extents in use and you do not supply the force flag, the command fails.

**Attention:** If this disk being removed has already been powered down, removed, or is experiencing a power outage, the migration is pending and does not complete until the MDisk comes back online. The MDisk is not removed from the list of MDisks that are contained in the group.

If the disk has been deliberately removed, the only method of removing the MDisk is to remove the entire group itself.

Ensure that you do not destroy any controller LUNs until you have deleted them from the MDisk group that they belong to.

The **rmmdisk** command fails if there are insufficient free extents on other disks in the mdisk group for the duration of the command.

If you do specify the force flag, an attempt will be made to migrate the extents that are in use onto other free extents within the group. If there are not enough free extents in the group, the command will fail even if the force flag is specified.

When an array MDisk is in a storage pool, five extents in the storage pool are reserved for internal use. If you attempt to remove an MDisk when an array MDisk is in the storage pool, the command will fail (even if the **-force** flag is specified), if five free extents do not remain in the storage pool.

To delete the disks from the group, you have the following options:

- You can delete the virtual disk that is using the extents specified on the managed disk.
- You can add more managed disks to the group, rerun the command and specify the **-force** parameter.

When data is being migrated from the managed disk, it might take some time for the command to complete. The command itself will return with a success code, notifying you that migration is in progress. An event is logged when the migration is complete and the disk is deleted from the group at this time. You can also check the progress of any active migrations by running the **lsmigrate** command.

If the **-force** parameter is used, the **rmmdisk** command fails if offline Managed Disks or no online quorum disks will prevent the migration. Correct the offline or quorum disk condition and try reissuing the command.

#### An invocation example

```
rmmdisk -mdisk mdisk12 -force Group3
```

#### The resulting output

No feedback

---

## rmmdiskgrp

The **rmmdiskgrp** command deletes a managed disk group so that there is no possibility to recover it.

### Syntax

```
►► rmmdiskgrp [-force] [mdisk_group_id | mdisk_group_name]
```

### Parameters

#### **-force**

(Optional) Specifies that all virtual disks and virtual disk-to-host mappings be deleted.

**Attention:** Use this parameter with extreme caution. When you use this parameter, all managed disks in the group are removed and the group itself is deleted.

*mdisk\_group\_id* | *mdisk\_group\_name*

(Required) Specifies the ID or name of the managed disk group that is to be deleted.

### Description

The **rmmdiskgrp** command deletes the specified managed disk group. The **-force** parameter is required if there are virtual disks that have been created from this group or if there are managed disks in the group. Otherwise, the command fails.



Deleting a managed disk group is essentially the same as deleting a cluster or part of a cluster, because the managed disk group is the central point of control of virtualization. Because virtual disks are created using available extents in the group, mapping between virtual disk extents and managed disk extents is controlled based on the group.

The command deletes all VDisk copies in the specified MDisk group. If the VDisk has no remaining synchronized copies in other MDisk groups, the VDisk is also deleted.

**Attention:**

1. This command partially completes asynchronously. All virtual disks, host mappings, and Copy Services relationships are deleted before the command completes. The deletion of the managed disk group then completes asynchronously.
2. Before you issue the command, ensure that you want to delete all mapping information; data that is contained on virtual disks cannot be recovered after the managed disk group has been deleted.

In detail, if you specify the **-force** parameter and the virtual disks are still using extents in this group, the following actions are initiated or occur:

- The mappings between that disk and any host objects and the associated Copy Services relationships are deleted.
- If the virtual disk is a part of a FlashCopy mapping, the mapping is deleted.

**Note:** If the mapping is not in the **idle\_or\_copied** or **stopped** states, the mapping is force-stopped and then deleted. Force-stopping the mapping might cause other FlashCopy mappings in the cluster to also be stopped. See the description for the **-force** parameter in the **stopfcmap** command for additional information.

- Any virtual disk that is in the process of being migrated into or out of the managed disk group is deleted. This frees up any extents that the virtual disk was using in another managed disk group.
- Virtual disks are deleted without first flushing the cache. Therefore, the storage controller LUNs that underlie any image mode MDisks might not contain the same data as the image mode VDisk prior to the deletion.
- If there are managed disks in the group, all disks are deleted from the group. They are returned to the unmanaged state.
- The group is deleted.

**Attention:** If you use the **-force** parameter to delete all the managed disk groups in your cluster, you are returned to the processing state where you were after you added nodes to the cluster. All data that is contained on the virtual disks is lost and cannot be recovered.

**An invocation example**

```
rmmdiskgrp -force Group3
```

**The resulting output**

```
No feedback
```



---

## Chapter 21. Metro Mirror and Global Mirror commands

The following Copy Service commands enable you to work with the Metro Mirror and Global Mirror services that the SAN Volume Controller provides.

---

### chpartnership

The **chpartnership** command modifies the bandwidth of the partnership between the local clustered system (system) and the remote system that is specified in the command. This affects the bandwidth that is available for background copy in a system partnership by either Metro Mirror or Global Mirror operations. This command can also be used to disable and re-enable the partnership, to permit the local system to be disconnected and then reconnected to the remote system.

#### Syntax

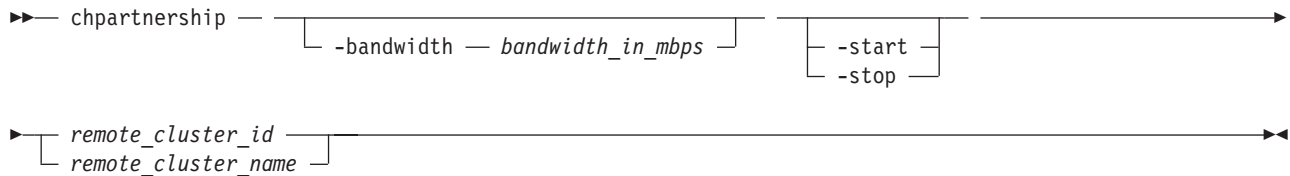

#### Parameters

##### **-bandwidth** *bandwidth\_in\_mbps*

(Optional) Specifies the new bandwidth in megabytes per second (MBps). This bandwidth is used to cap the background remote copy progress. Set the bandwidth to the maximum rate that the remote copies should resynchronize at. Write operations from the host add to the use of the system link. If this parameter is set to a value that is greater than the inter-system links can sustain, the actual copy rate defaults to what is available on the link.

##### **-start** | **-stop**

(Optional) Starts or stops a Metro Mirror or Global Mirror partnership. To start or stop a partnership, run the **chpartnership** command from either system.

##### *remote\_cluster\_id* | *remote\_cluster\_name*

(Required) Specifies the system ID or name of the remote system. The intra-system bandwidth cannot be modified, so if you enter the local system name or ID, an error occurs.

#### Description

This command modifies the bandwidth of the partnership between the local system and the remote system that is specified in the command. This affects the bandwidth that is available for a background copy in Metro Mirror or Global Mirror relationships, in the direction from the local to the remote system. To modify the background copy bandwidth in the other direction (remote system→ local system), it is necessary to issue the corresponding **chpartnership** command to the remote system.

When you stop the system partnership, you temporarily disable the partnership and disconnect the local system from the remote system. The configuration is retained. The system partnership must be in either the `partially_configured_stopped` or `fully_configured_stopped` states to be started.

#### An invocation example

```
chpartnership -bandwidth 20 cluster1
chpartnership -stop cluster1
```

## The resulting output

No feedback

---

## chrconsistgrp

The **chrconsistgrp** command modifies the name of an existing Metro Mirror or Global Mirror consistency group.

### Syntax

```
➤ chrconsistgrp -- -name -- new_name_arg -- [rc_consist_group_name | rc_consist_group_id]
```

### Parameters

**-name** *new\_name\_arg*

(Required) Specifies the new name to assign to the consistency group.

*rc\_consist\_group\_name* | *rc\_consist\_group\_id*

(Required) Specifies the ID or existing name of the consistency group that you want to modify.

### Description

This command changes the name of the specified consistency group.

### An invocation example

Change the name of the consistency group called `rc_testgrp` to `rctestone`.

```
chrconsistgrp -name rctestone rc_testgrp
```

## The resulting output

No feedback

---

## chrrelationship

The **chrrelationship** command enables you to modify certain attributes of an existing relationship, such as to add a relationship to a consistency group, to remove a relationship from a consistency group, and to change the name of the relationship. You can only change one attribute at a time per command submittal.

### Syntax

```
➤ chrrelationship -- [-name -- new_name_arg | -force | -consistgrp [consist_group_id | consist_group_name]] [rc_rel_id | rc_rel_name]
```

### Parameters

**-name** *new\_name\_arg*

(Optional) Specifies a new label to assign to the relationship.

This parameter is required if you do not specify the **-consistgrp** or **-force** parameter.

**-consistgrp** *consist\_group\_id* | *consist\_group\_name*

(Optional) Specifies a new consistency group to assign the relationship to. Only relationships of the

same copy type (Metro Mirror or Global Mirror) can be assigned to the same consistency group. You cannot use this parameter with the **-name**, or **-force** parameters.

This parameter is required if you do not specify the **-name** or **-force** parameter.

#### **-force**

(Optional) Specifies that you want the system to remove the relationship from a consistency group making the relationship a stand-alone relationship. You cannot use this parameter with the **-name** or **-consistgrp** parameters.

This parameter is required if you do not specify the **-name** or **-consistgrp** parameter.

*rc\_rel\_name* | *rc\_rel\_id*

(Required) Specifies the ID or name of the relationship.

## **Description**

This command modifies the specified attributes of the supplied relationship, one attribute at a time; you cannot use more than one of the three optional parameters in the same command. In addition to changing the name of a consistency group, this command can be used for the following purposes.

- You can add a stand-alone relationship to a consistency group by specifying the **-consistgrp** parameter and the name or ID of the consistency group. The relationship and consistency group must be connected when the command is issued and must share the following components:
  - Master cluster
  - Auxiliary cluster
  - State (unless the group is empty)
  - Primary (unless the group is empty)
  - Type (unless the group is empty)

When the first relationship is added to an empty group, the group takes on the same state, primary (copy direction), and type (Metro or Global Mirror) as the relationship. Subsequent relationships must have the same state, copy direction, and type as the group in order to be added to it. A relationship can only belong to one consistency group.

- You can remove a relationship from a consistency group by specifying the **-force** parameter and the name or ID of the relationship. Although you do not have to specify or confirm the name of the consistency group, verify which group the relationship belongs to before you issue this command.

This form of the modify relationship command succeeds in the connected or disconnected states. If the clusters are disconnected the relationship is only removed from the consistency group on the local cluster, at the time the command is issued. When the clusters are reconnected the relationship is automatically removed from the consistency group on the other cluster. Alternatively, you can issue an explicit modify (**chrrelationship**) command to remove the relationship from the group on the other cluster while it is still disconnected.

**Note:** If you remove all relationships from the group, the relationship type is reset to **empty\_group**. When you add a relationship to the empty group, the group again takes on the same type as the relationship.

- To move a relationship between two consistency groups, you must issue the **chrrelationship** command twice. Use the **-force** parameter to remove the relationship from its current group, and then use the **-consistgrp** parameter with the name of the new consistency group.

### **An invocation example**

Change the name of the relationship `rccopy1` to `testrel`.

```
chrrelationship -name testrel rccopy1
```

### **The resulting output**

No feedback

### An invocation example

Add relationship rccopy2 to group called newgroup.

```
chrcrelationship -consistgrp newgroup rccopy2
```

### The resulting output

No feedback

### An invocation example

Remove relationship rccopy3 from whichever consistency group it is a member of.

```
chrcrelationship -force rccopy3
```

### The resulting output

No feedback

---

## mkpartnership

The **mkpartnership** command establishes a one-way Metro Mirror or Global Mirror relationship between the local clustered system (system) and a remote system.

### Syntax

To establish a fully functional Metro Mirror or Global Mirror partnership, you must issue this command to both systems. This step is a prerequisite to creating Metro Mirror or Global Mirror relationships between volumes on the systems.

```
▶▶— mkpartnership — — -bandwidth — bandwidth_in_mbps — — [remote_cluster_id | remote_cluster_name] —▶▶
```

### Parameters

**-bandwidth** *bandwidth\_in\_mbps*

(Required) Specifies the bandwidth, in megabytes per second (MBps), that is used by the background copy process between the systems. It adjusts the bandwidth that is used by Metro Mirror or Global Mirror for the initial background copy process. Set the bandwidth to a value that is less than or equal to the bandwidth that can be sustained by the intersystem link. If the **-bandwidth** parameter is set to a higher value than the link can sustain, the background copy process uses the actual available bandwidth.

*remote\_cluster\_id* | *remote\_cluster\_name*

(Required) Specifies the system ID or name of the remote system. Issue the **lsclustercandidate** command to list the remote systems that are available. If two or more remote systems have the same name and the name is included in this command, the command fails and it requests the ID of the system instead of the name.

### Description

This command creates a one-way partnership between the local system and the remote system that you specify in the command. To create a two-way partnership, the equivalent **mkpartnership** command must be issued from the other system. The maximum supported number of systems in a partnership set is four.

Intersystem Mirror relationships can be created between primary volumes in the local system and auxiliary volumes in the remote system. Intrasystem relationships can be created between volumes that reside in a local system. The volumes must belong to the same I/O group within the system.

**Note:** Background copy bandwidth can impact foreground I/O latency. To set the background copy bandwidth optimally, you must consider all three resources: the primary storage, intersystem link bandwidth, and secondary storage. Provision the most restrictive of these three resources between the background copy bandwidth and the peak foreground I/O workload.

#### An invocation example

```
mkpartnership -bandwidth 20 cluster1
```

#### The resulting output

No feedback

---

## mkrcconsistgrp

The **mkrcconsistgrp** command creates a new, empty Metro Mirror or Global Mirror consistency group. If the **-cluster** parameter is not specified, the consistency group is created on the local cluster only.

### Syntax

```
➤ mkrcconsistgrp — [-name new_name] [-cluster cluster_id | cluster_name] ➤
```

### Parameters

**-name** *new\_name*

(Optional) Specifies a name for the new consistency group.

**-cluster** *cluster\_id* | *cluster\_name*

(Optional) Specifies the name or ID of the remote cluster. If **-cluster** is not specified, a consistency group is created only on the local cluster.

### Description

This command creates a new consistency group. The ID of the new group is displayed after the command processes. The name must be unique across all consistency groups that are known to the clusters within this consistency group. If the consistency group involves two clusters, the clusters must be in communication throughout the create process.

The new consistency group does not contain any relationships and will be in the empty state. You can add Metro Mirror or Global Mirror relationships to the group using the **chrrelationship** command.

#### An invocation example

```
mkrcconsistgrp -name rc_testgrp
```

#### The resulting output

```
RC Consistency Group, id [255], successfully created
```

---

## mkrcrelationship

| The **mkrcrelationship** command creates a new Metro Mirror or Global Mirror relationship with volumes in the same cluster (intracluster relationship) or in two different clusters (intercluster relationship).

## Syntax

```
mkcrrelationship - - -master [master_vdisk_id | master_vdisk_name] - -aux [aux_vdisk_id | aux_vdisk_name]
- -cluster [cluster_id | cluster_name] [-name new_name_id]
- -consistgrp [consist_group_id | consist_group_name] [-sync] [-global]
```

## Parameters

**-master** *master\_vdisk\_id* | *master\_vdisk\_name*  
(Required) Specifies the ID or name of the master volume.

**-aux** *aux\_vdisk\_id* | *aux\_vdisk\_name*  
(Required) Specifies the ID or name of the auxiliary volume.

**-cluster** *cluster\_id* | *cluster\_name*  
(Required) Specifies the ID or name of the remote cluster.

If you are creating an intracluster relationship, enter the ID of the local cluster. The volumes in the relationship must belong to the same I/O group within the cluster.

If you are creating an intercluster relationship, enter the ID of the remote cluster. To create a relationship in two different clusters, the clusters must be connected at the time that the **mkcrrelationship** command is received.

**-name** *new\_name\_id*  
(Optional) Specifies a label to assign to the relationship.

**-consistgrp** *consist\_group\_id* | *consist\_group\_name*  
(Optional) Specifies a consistency group that this relationship joins. If you do not supply the **-consistgrp** parameter, the relationship is created as a stand-alone relationship that can be started, stopped, and switched on its own.

**Note:** Metro and Global Mirror relationships cannot belong to the same consistency group. When the first relationship is added to the consistency group, the group takes on the same type as the relationship. Subsequently, only relationships of that type can be added to the consistency group.

**-sync**  
(Optional) Specifies that you want the system to create a synchronized relationship. The **-sync** parameter guarantees that the master and auxiliary disks contain identical data at the point that the relationship is created. You must ensure that the auxiliary disk is created to match the master disk and that no input transactions take place to either disk before you issue the create command. The initial background synchronization is skipped.

**-global**  
(Optional) Specifies that you want the system to create a new Global Mirror relationship. If you do not specify the **-global** parameter, a Metro Mirror relationship is created instead.

## Description

This command creates a new Metro Mirror or Global Mirror relationship. A Metro Mirror relationship defines the relationship between two volumes: a master volume and an auxiliary volume. This relationship persists until it is deleted. The auxiliary virtual disk must be identical in size to the master virtual disk or the command fails, and if both volumes are in the same cluster, they must both be in the same I/O group. The master and auxiliary cannot be in an existing relationship. Any defined FlashCopy



| mappings that have the proposed master volume as the target of the FlashCopy mapping must be using  
| the same I/O group as the master volume. Any defined FlashCopy mappings that have the proposed  
| auxiliary volume as the target of the FlashCopy mapping must be using the same I/O group as the  
| auxiliary volume.

| **Note:** You cannot create a remote copy relationship with this command if the auxiliary volume is an  
| active FlashCopy mapping target.

The command also returns the new relationship ID.

Metro Mirror relationships use one of the following copy types:

- A Metro Mirror copy ensures that updates are committed to both the primary and secondary volumes before sending confirmation of I/O completion to the host application. This ensures that the secondary volume is synchronized with the primary volume in the event that a failover operation is performed.
- A Global Mirror copy allows the host application to receive confirmation of I/O completion before the updates are committed to the secondary volume. If a failover operation is performed, the host application must recover and apply any updates that were not committed to the secondary volume.

You can optionally give the relationship a name. The name must be a unique relationship name across both clusters.

The relationship can optionally be assigned to a consistency group. A consistency group ensures that a number of relationships are managed so that, in the event of a disconnection of the relationships, the data in all relationships within the group is in a consistent state. This can be important in, for example, a database application where data files and log files are stored on separate volumes and consequently are managed by separate relationships. In the event of a disaster, the primary and secondary sites might become disconnected. As the disconnection occurs and the relationships stop copying data from the primary to the secondary site, there is no assurance that updates to the two separate secondary volumes will stop in a consistent manner if the relationships that are associated with the volumes are not in a consistency group.

For proper database operation, it is important that updates to the log files and the database data are made in a consistent and orderly fashion. It is crucial in this example that the log file volume and the data volume at the secondary site are in a consistent state. This can be achieved by putting the relationships that are associated with these volumes into a consistency group. Both Metro Mirror and Global Mirror processing ensure that updates to both volumes at the secondary site are stopped, leaving a consistent image based on the updates that occurred at the primary site.

If you specify a consistency group, both the group and the relationship must have been created using the same master cluster and the same auxiliary cluster. The relationship must not be a part of another consistency group. If the consistency group is *empty*, it acquires the type of the first relationship that is added to it. Therefore, each subsequent relationship that you add to the consistency group must have the same type.

If the consistency group is *not empty*, the consistency group and the relationship must be in the same state. If the consistency group is *empty*, it acquires the state of the first relationship that is added to it. If the state has an assigned copy direction, the direction of the consistency group and the relationship must match that direction.

If you do not specify a consistency group, a stand-alone relationship is created.

If you specify the **-sync** parameter, the master and auxiliary virtual disks contain identical data at the point when the relationship is created. You must ensure that the auxiliary is created to match the master and that no data movement occurs to either virtual disk before you issue the **mkrrelationship** command.

If you specify the **-global** parameter, a Global Mirror relationship is created. Otherwise, a Metro Mirror relationship is created instead.

#### An invocation example

```
mkrcrelationship -master vdisk1 -aux vdisk2 -name rccopy1
-cluster 0000020063432AFD
```

#### The resulting output

```
RC Relationship, id [28], successfully created
```

---

## rmpartnership

The **rmpartnership** command removes a Metro Mirror or Global Mirror partnership on one cluster. Because the partnership exists on both clusters, it is necessary to run this command on both clusters to remove both sides of the partnership. If the command is run on only one cluster, the partnership enters a partially configured state on the other cluster.

### Syntax

```
►► rmpartnership — [remote_cluster_id | remote_cluster_name]
```

### Parameters

*remote\_cluster\_id* | *remote\_cluster\_name*  
(Required) Specifies the cluster ID or the name of the remote cluster.

### Description

This command deletes one half of a partnership on a cluster. To remove the entire partnership, you must run the command twice, once on each cluster.

**Attention:** Before running the **rmpartnership** command, you must remove all relationships and groups that are defined between the two clusters. To display cluster relationships and groups, run the **lsrcrelationship** and **lsrcconsistgrp** commands. To remove the relationships and groups that are defined between the two clusters, run the **rmrcrelationship** and **rmrcconsistgrp** commands.

#### An invocation example

```
rmpartnership cluster1
```

#### The resulting output

```
No feedback
```

---

## rmrcconsistgrp

The **rmrcconsistgrp** command deletes an existing Metro Mirror or Global Mirror consistency group.

### Syntax

```
►► rmrcconsistgrp — [-force] [rc_consist_group_id | rc_consist_group_name]
```

## Parameters

### **-force**

(Optional) Specifies that you want the system to remove all relationships belonging to a group before the consistency group is deleted. The relationships themselves are not deleted; they become stand-alone relationships.

**Note:** The **-force** parameter must be used to delete a consistency group when the consistency group has any Metro Mirror or Global Mirror relationships that is associated with it. If you do not use the **-force** parameter, the command fails.

*rc\_consist\_group\_id* | *rc\_consist\_group\_name*

(Required) Specifies the ID or the name of the consistency group to delete.

## Description

This command deletes the specified consistency group. You can issue this command for any existing consistency group. If the consistency group is disconnected at the time that the command is issued, the consistency group is only deleted on the cluster that is connected. When the clusters reconnect, the consistency group is automatically deleted on the other cluster. Alternatively, if the clusters are disconnected, and you still want to remove the consistency group on both clusters, you can issue the **rmrconsistgrp** command separately on both of the clusters.

If the consistency group is not empty, the **-force** parameter is required to delete the group. This removes the relationships from the consistency group before the group is deleted. These relationships become stand-alone relationships. The state of these relationships is not changed by the action of removing them from the consistency group.

### An invocation example

```
rmrconsistgrp rctestone
```

### The resulting output

No feedback

---

## rmrrelationship

The **rmrrelationship** command deletes an existing Metro Mirror or Global Mirror relationship.

## Syntax

```
➤— rmrrelationship — [rc_rel_id | rc_rel_name] —➤
```

## Parameters

*rc\_rel\_id* | *rc\_rel\_name*

(Required) Specifies the ID or the name of the relationship.

## Description

This command deletes the relationship that is specified.

Deleting a relationship only deletes the logical relationship between the two virtual disks; it does not affect the virtual disks themselves.

If the relationship is disconnected at the time that the command is issued, the relationship is only deleted on the cluster where the command is being run. When the clusters reconnect, the relationship is automatically deleted on the other cluster. Alternatively, if the clusters are disconnected and if you still want to remove the relationship on both clusters, you can issue the **rmrcrelationship** command independently on both of the clusters.

If you delete an inconsistent relationship, the secondary virtual disk becomes accessible even though it is still inconsistent. This is the one case in which Metro or Global Mirror does not inhibit access to inconsistent data.

### An invocation example

```
rmrcrelationship rccopy1
```

### The resulting output

No feedback

---

## startrcconsistgrp

The **startrcconsistgrp** command starts the Metro Mirror or Global Mirror consistency group copy process, sets the direction of copy if it is undefined, and optionally marks the secondary volumes of the consistency group as clean.

### Syntax

```
▶▶ startrcconsistgrp — [-primary master | aux] [-force] [-clean]
▶ [rc_consist_group_id | rc_consist_group_name]
```

### Parameters

**-primary** *master* | *aux*

(Optional) Specifies the copy direction by defining whether the master or auxiliary disk becomes the primary (source). This parameter is required when the primary is undefined if, for example, the consistency group is in the **Idling** state.

**-force**

(Optional) Specifies that you want the system to process the copy operation even if it might lead to a temporary loss of consistency while synchronization occurs. This parameter is required if the consistency group is in the **ConsistentStopped** state, but is not synchronized or is in the **Idling** state, but is not synchronized.

**-clean**

(Optional) Specifies that the volume that is to become a secondary is clean for each of the relationships belonging to the group; any changes made on the secondary volume are ignored, and only changes made on the clean primary volume are considered during synchronization of the primary and secondary disks. The consistency group must be in an **Idling** (connected) state for this parameter to work.

**Attention:** This flag should only be used when the primary and secondary volumes contain identical data. Otherwise, relationships that are not consistent are reported as consistent. Once this has been done there is no method to determine whether these volumes ever reach a true consistent state until a full background copy can be carried out again.

*rc\_consist\_group\_id* | *rc\_consist\_group\_name*

(Required) Specifies the ID or name of the consistency group to start.

## Description

- | This command starts a Metro Mirror or Global Mirror stand-alone consistency group. You cannot use this
- | command to start a remote copy relationship if the primary volume is a target volume of a prepared
- | FlashCopy mapping.

This command can only be issued to a consistency group that is connected. For a consistency group that is idling, this command assigns a copy direction (primary and secondary roles) and begins the copy process. Otherwise, this command restarts a previous copy process that was stopped either by a stop command or by an I/O error.

If the resumption of the copy process leads to a period of time when the relationship is not consistent, then you must specify the **-force** parameter when you restart the relationship. This situation can arise if the relationship had been stopped and then further input transactions had been performed on the original primary disk of the relationship. When you use the **-force** parameter in this situation, the data on the secondary disk is not usable (because it is inconsistent) in a disaster recovery circumstance.

In the idling state, you must provide the **-primary** parameter. In other connected states, you can provide the **-primary** parameter, but it must match the existing setting.

The **-force** parameter is required if consistency would be lost by starting a copy operation. This can occur if write operations on either primary or secondary volumes have taken place since the **ConsistentStopped** or **idling** state occurred. If the command is issued without the **-force** parameter in such circumstances, the command fails. In general, the **-force** parameter is required if the group is in one of the following states:

- Consistent\_Stopped but not synchronized (sync=out\_of\_sync)
- Idling but not synchronized

The **-force** parameter is not required if the group is in one of the following states:

- Inconsistent\_Stopped
- Inconsistent\_Copying
- Consistent\_Synchronized

However, the command does not fail if you specify the **-force** parameter.

The **-clean** parameter is used when a Metro Mirror or Global Mirror group is started and the secondary volumes in this group are assumed to be clean. Clean in this sense, means that any changes that have been made at the secondary are ignored and only changes made at the primary are considered when synchronizing the primary and secondary volumes. The **-clean** parameter can be used in the following scenario:

1. A consistency group is created with the **-sync** parameter. At this point, it does not matter if the primary and secondary contain the same data, even though the use of the **-sync** parameter implies that this is true.
2. A **stoprcconsistgrp** command is issued with the **-access** parameter. This permits access to the secondary disk. Change recording begins at the primary.
3. An image of the primary disk is copied and loaded on to the secondary disk. It is permissible to allow updates to the primary disk during the image copy as this image can be only a fuzzy image of the primary disk.
4. A **startrcconsistgrp** command that specifies the **-primary master**, **-force**, and **-clean** parameters is issued. The auxiliary disk is marked as clean and changes on the master disk that have occurred since the relationship was stopped are copied to the auxiliary disk.

5. Once the background copy has completed, relationships in the group become consistent and synchronized.

### An invocation example

```
starttrconsistgrp rccopy1
```

### The resulting output

No feedback

---

## startrelationship

The **startrelationship** command starts the Metro Mirror or Global Mirror relationship copy process, sets the direction of copy if undefined, and optionally, marks the secondary volume of the relationship as clean. The relationship must be a stand-alone relationship.

### Syntax

```
▶▶ startrelationship [-primary master | aux] [-force] [-clean] rc_rel_id rc_rel_name ▶▶
```

### Parameters

**-primary** *master* | *aux*

(Optional) Specifies the copy direction by defining whether the master or auxiliary disk becomes the primary (source). This parameter is required when the primary is undefined if, for example, the relationship is in the idling state.

**-force**

(Optional) Specifies that you want the system to process the copy operation even if it might lead to a temporary loss of consistency while synchronization occurs. This parameter is required if the relationship is in the **Consistentstopped** state, but is not synchronized or in the Idling state, but is not synchronized.

**-clean**

(Optional) Specifies that the volume that is to become a secondary is clean; any changes made on the secondary volume are ignored, and only changes made on the clean primary volume are considered when synchronizing the primary and secondary disks. The relationship must be in an Idling (connected) state for this parameter to work.

**Attention:** This flag should only be used when the primary and secondary volumes contain identical data. Otherwise, relationships that are not consistent are reported as consistent. Once this has been done there is no method to determine whether these volumes ever reach a true consistent state until a full background copy can be carried out again.

*rc\_rel\_id* | *rc\_rel\_name*

(Required) Specifies the ID or name of the relationship that you want to start in a stand-alone relationship.

### Description

The **startrelationship** command starts a stand-alone relationship. The command fails if it is used to start a relationship that is part of a consistency group.

This command can only be issued to a relationship that is connected. For a relationship that is idling, this command assigns a copy direction (primary and secondary roles) and begins the copy process. Otherwise, this command restarts a previous copy process that was stopped either by a stop command or by some I/O error.

- | **Note:** A command in idling state is rejected if any of the indicated secondary volumes is the target of an existing FlashCopy map.
- | If the FlashCopy mapping is active, the remote copy cannot be started.
- | In the idling state, you must provide the **-primary** parameter. In other connected states, you can provide the **-primary** parameter, but it must match the existing setting.
- | The **-force** parameter is required if consistency would be lost by starting a copy operation. This can occur if input transactions have occurred on either the primary or secondary volumes since the ConsistentStopped or Idling state occurred. This happens when the relationship is in either of these states:
  - | • ConsistentStopped but not synchronized
  - | • Idling but not synchronized
- | After restarting a relationship in either of these states, the data on the secondary volume is not usable for disaster recovery until the relationship becomes consistent.
- | The **-force** parameter is not required if the relationship is in one of the following states:
  - | • InconsistentStopped
  - | • InconsistentCopying
  - | • ConsistentSynchronized
- | However, the command does not fail if you specify the **-force** parameter.

The **-clean** parameter is used when a Metro Mirror or Global Mirror relationship is started and the secondary volume in the relationship is assumed to be clean; any changes made on the secondary volume are ignored, and only changes made on the clean primary volume are considered when synchronizing the primary and secondary disks. The **-clean** parameter can be used in the following circumstance:

1. A relationship is created with the **-sync** parameter specified. (At this point it does not matter if the primary and secondary disks contain the same data, even though the use of the **-sync** parameter implies that this is true).
2. A **stoptrcrelationship** command is issued with the **-access** parameter specified. This permits access to the secondary disk. Change recording begins at the primary disk.
3. An image of the primary disk is copied and loaded on to the secondary disk. It is permissible to allow updates to the primary disk during the image copy as this image need only be a *fuzzy* image of the primary disk.
4. A **starttrcrelationship** command that specifies the **-primary master**, **-force**, and **-clean** parameters is issued. The auxiliary disk is marked as clean and changes on the master disk that have occurred since the relationship was stopped are copied to the auxiliary disk.
5. Once the background copy has completed, the relationship becomes consistent and synchronized.

#### An invocation example

```
starttrcrelationship rccopy1
```

#### The resulting output

```
No feedback
```

## stoprcconsistgrp

The **stoprcconsistgrp** command stops the copy process for a Metro Mirror or Global Mirror consistency group. This command can also be used to enable write access to the secondary volumes in the group if the group is in a consistent state.

### Syntax

```
stoprcconsistgrp [-access] [rc_consist_group_id | rc_consist_group_name]
```

### Parameters

#### -access

(Optional) Allows write access to consistent secondary volumes in the consistency group.

*rc\_consist\_group\_id* | *rc\_consist\_group\_name*

(Required) Specifies the ID or the name of the consistency group to stop all processing for.

### Description

This command applies to a consistency group. You can issue this command to stop processing on a consistency group that is copying from primary volumes to secondary volumes.

If the consistency group is in an inconsistent state, all copy operations stop and do not resume until you issue the **startrcconsistgrp** command. For a consistency group in the `consistent_synchronized` state, this command causes a consistency freeze.

When a consistency group is in a consistent state (for example, in the `consistent_stopped`, `consistent_synchronized`, or `consistent_disconnected` state) you can issue the **access** parameter with the **stoprcconsistgrp** command to enable write access to the secondary virtual disks within that group. Table 47 shows consistency group initial and final states:

Table 47. **stoprcconsistgrp** consistency group states

| Initial state                        | Final state                       | Notes                                                                                                                                                           |
|--------------------------------------|-----------------------------------|-----------------------------------------------------------------------------------------------------------------------------------------------------------------|
| <code>inconsistent_stopped</code>    | <code>inconsistent_stopped</code> | If <b>access</b> is specified, the command is rejected.                                                                                                         |
| <code>inconsistent_copying</code>    | <code>inconsistent_stopped</code> | If <b>access</b> is specified, the command is rejected with no effect and the relationship remains in the <code>inconsistent_copying</code> state.              |
| <code>consistent_stopped</code>      | <code>consistent_stopped</code>   | If <b>access</b> is specified, the final state is <code>idling</code> .                                                                                         |
| <code>consistent_synchronized</code> | <code>consistent_stopped</code>   | If <b>access</b> is specified, the final state is <code>idling</code> . If <b>access</b> is not specified, the final state is <code>consistent_stopped</code> . |
| <code>idling</code>                  | <code>idling</code>               | Remains in <code>idling</code> state whether <b>access</b> is specified or not.                                                                                 |



Table 47. **stoprcconsistgrp** consistency group states (continued)

| Initial state             | Final state          | Notes                                                                                                                                                                                                                       |
|---------------------------|----------------------|-----------------------------------------------------------------------------------------------------------------------------------------------------------------------------------------------------------------------------|
| idling_disconnected       | unchanged            | If specified without <b>access</b> , the relationship/group remains in idling_disconnected state. If the clustered systems reconnect, the relationship/group is in either inconsistent_stopped or consistent_stopped state. |
| inconsistent_disconnected | inconsistent_stopped | The command is rejected, with or without the <b>access</b> flag.                                                                                                                                                            |
| consistent_disconnected   | consistent_stopped   | The command is rejected if specified without <b>access</b> . If specified with <b>access</b> , the relationship/group moves to idling_disconnected.                                                                         |

### An invocation example

```
stoprcconsistgrp rccopy1
```

### The resulting output

No feedback

---

## stoprcrelationship

The **stoprcrelationship** command stops the copy process for a Metro Mirror or Global Mirror stand-alone relationship. You can also use this command to enable write access to a consistent secondary volume.

### Syntax

```

▶▶ stoprcrelationship [-access] [rc_rel_id | rc_rel_name]

```

### Parameters

#### -access

(Optional) Specifies that the system allow write access to a consistent secondary volume.

*rc\_rel\_id* | *rc\_rel\_name*

(Required) Specifies the ID or the name of the relationship to stop all processing for.

### Description

The **stoprcrelationship** command applies to a stand-alone relationship. The command is rejected if it is addressed to a relationship that is part of a consistency group. You can issue this command to stop a relationship that is copying from primary to secondary volumes.

If the relationship is in an inconsistent state, any copy operation stops and does not resume until you issue a **starttrcrelationship** command. For a relationship in the consistent\_synchronized state, this command causes a consistency freeze.

When a relationship is in a consistent state – in the consistent\_stopped, consistent\_synchronized, or consistent\_disconnected state – you can use the **access** parameter to enable write access to the secondary virtual disk. Table 48 on page 346 provides consistency group initial and final states.

Table 48. stopprrelationship consistency group states

| Initial state             | Final state          | Notes                                                                                                                                                                                                                       |
|---------------------------|----------------------|-----------------------------------------------------------------------------------------------------------------------------------------------------------------------------------------------------------------------------|
| inconsistent_stopped      | inconsistent_stopped | If <b>access</b> is specified, the command is rejected.                                                                                                                                                                     |
| inconsistent_copying      | inconsistent_stopped | If <b>access</b> is specified, the command is rejected with no effect and the relationship remains in the inconsistent_copying state.                                                                                       |
| consistent_stopped        | consistent_stopped   | If <b>access</b> is specified, the final state is idling.                                                                                                                                                                   |
| consistent_synchronized   | consistent_stopped   | If <b>access</b> is specified, the final state is idling. If <b>access</b> is not specified, the final state is consistent_stopped.                                                                                         |
| idling                    | idling               | Remains in idling state whether <b>access</b> is specified or not.                                                                                                                                                          |
| idling_disconnected       | unchanged            | If specified without <b>access</b> , the relationship/group remains in idling_disconnected state. If the clustered systems reconnect, the relationship/group is in either inconsistent_stopped or consistent_stopped state. |
| inconsistent_disconnected | inconsistent_stopped | The command is rejected, with or without the <b>access</b> flag.                                                                                                                                                            |
| consistent_disconnected   | consistent_stopped   | The command is rejected if specified without <b>access</b> . If specified with <b>access</b> , the relationship/group moves to idling_disconnected.                                                                         |

### An invocation example

```
stopprrelationship rccopy1
```

### The resulting output

No feedback

---

## switchrconsistgrp

The **switchrconsistgrp** command reverses the roles of the primary and secondary volumes in a Metro Mirror or Global Mirror consistency group when that consistency group is in a consistent state. All the relationships in the consistency group are affected by this change.

### Syntax

```

▶▶ switchrconsistgrp — — -primary —┬─ master ─┬─ rc_consist_group_id ─┬─▶
 │ aux ─┬─ rc_consist_group_name ─┬─

```

### Parameters

**-primary master | aux**

(Required) Specifies whether the master or auxiliary side of the relationships in the group will become the primary volumes.

*rc\_consist\_group\_id* | *rc\_consist\_group\_name*

(Required) Specifies the ID or name of the consistency group to switch.

## Description

This command applies to a consistency group. It is normally issued to reverse the roles of the primary and secondary virtual disks in a consistency group, perhaps as part of a failover process that is associated with a disaster recovery event. Write access to the former primary volumes is lost and write access to the new primary volumes is acquired. This command is successful when the consistency group is in a connected, consistent state, and when reversing the direction of the relationships would not lead to a loss of consistency, for example, when the consistency group is consistent and synchronized. The consistency group must be in one of the following states in order for the **switchrconsistgrp** command to process correctly:

- ConsistentSynchronized
- ConsistentStopped and Synchronized
- Idling and Synchronized

**Note:** This command will be rejected under either of the following conditions:

- You switch consistency group relationship so that the new secondary becomes the target volume of an active FlashCopy mapping.
- Any of the indicated secondary volumes (in the consistency group) are the target of an existing FlashCopy mapping.

The consistency group moves to the ConsistentSynchronized state after the successful completion of this command. If you specify the **-primary** parameter and it is the same as the current primary, the command has no effect.

### An invocation example

```
switchrconsistgrp -primary aux rccopy2
```

### The resulting output

No feedback

---

## switchrrelationship

The **switchrrelationship** command reverses the roles of primary and secondary virtual disks in a stand-alone Metro Mirror or Global Mirror relationship when that relationship is in a consistent state.

## Syntax

```
switchrrelationship - - -primary [master | aux] [rc_rel_id | rc_rel_name]
```

## Parameters

**-primary master | aux**

(Required) Specifies whether the master disk or the auxiliary disk is to be the primary.

*rc\_rel\_id* | *rc\_rel\_name*

(Required) Specifies the ID or the name of the relationship to switch.

## Description

The **switchrrelationship** command applies to a stand-alone relationship. It is rejected if it is used to try to switch a relationship that is part of a consistency group. It is normally issued to reverse the roles of the

primary and secondary virtual disk in a relationship perhaps as part of a failover process during a disaster recovery event. Write access to the old primary disk is lost and write access to the new primary disk is acquired. This command is successful when the relationship is in a connected, consistent state, and when reversing the direction of the relationship does not lead to a loss of consistency; that is, when the relationship is consistent and synchronized. The relationship must be in one of the following states in order for the **switchrcrelationship** command to process correctly:

- ConsistentSynchronized
- ConsistentStopped and Synchronized
- Idling and Synchronized

| **Note:** A command in idling state is rejected if any of the indicated secondary volumes is the target of  
| an existing FlashCopy map.

The relationship moves to the **ConsistentSynchronized** state after the successful completion of this command. If you specify the **-primary** parameter with the current primary, the command has no effect.

### **An invocation example**

```
switchrcrelationship -primary master rccopy2
```

### **The resulting output**

No feedback

---

## Chapter 22. Migration commands

The following commands enable you to work with migration options with the SAN Volume Controller.

---

### migrateexts

The **migrateexts** command migrates extents from one managed disk to another.

#### Syntax

```
► migrateexts -- -source [source_mdisk_id | source_mdisk_name] -- -target [target_mdisk_id | target_mdisk_name]
► -exts number_of_extents [-threads number_of_threads] [-copy id]
► -vdisk [vdisk_id | vdisk_name]
```

#### Parameters

**-source** *source\_mdisk\_id* | *source\_mdisk\_name*

(Required) Specifies the MDisk on which the extents currently reside.

**-target** *target\_mdisk\_id* | *target\_mdisk\_name*

(Required) Specifies the MDisk to migrate the extents to.

**-exts** *number\_of\_extents*

(Required) Specifies the number of extents to migrate.

**-threads** *number\_of\_threads*

(Optional) Specifies the number of threads to use while migrating these extents. You can specify 1 - 4 threads. The default number of threads is 4.

**-copy** *id*

(Required if the specified VDisk has more than one copy) Specifies the VDisk copy that the extents belong to.

**-vdisk** *vdisk\_id* | *vdisk\_name*

(Required) Specifies the VDisk that the extents belong to.

#### Description

This command migrates a given number of extents from the source virtual disk and the managed disk that contains extents that are used to make up the virtual disk. The target is a managed disk within the same managed disk group.

If a large number of extents are being migrated, you can specify 1 - 4 threads. You can issue the **lsmigrate** command to check the progress of the migration.

The **migrateexts** command fails if there are insufficient free extents on the target managed disk. To avoid this problem, do not issue new commands that use extents until the extents migration is completed.

The **migrateexts** command fails if the target or source VDisk is offline, or if Easy Tier is active for the VDisk copy. Correct the offline condition before attempting to migrate the VDisk.

**Note:** Migration activity on a single managed disk is limited to a maximum of 4 concurrent operations. This limit does not take into account whether the managed disk is the source or the destination target. If more than four migrations are scheduled for a particular managed disk, further migration operations are queued pending the completion of one of the currently running migrations. If a migration operation is stopped for any reason, a queued migration task can be started. However, if a migration is suspended, the current migration continues to use resources and a pending migration is not started. For example, the following setup is a possible initial configuration:

- MDiskGrp 1 has VDisk 1 created in it
- MDiskGrp 2 has VDisk 2 created in it
- MDiskGrp 3 has only one MDisk

With the previous configuration, the following migration operations are started:

- Migration 1 migrates VDisk 1 from MDiskGrp 1 to MDiskGrp 3, running with 4 threads.
- Migration 2 migrates VDisk 2 from MDiskGrp 2 to MDiskGrp 3, running with 4 threads.

Due to the previous limitations, the two migration operations do not always run at the same speed. MDiskGrp 3 has only one MDisk and the two migration operations have a total of 8 threads that are trying to access the one MDisk. Four threads are active. The remaining threads are in standby mode waiting to access the MDisk.

### An invocation example

```
migrateexts -vdisk vdisk4 -source mdisk4 -exts
64 -target mdisk6 -threads 4
```

### The resulting output

No feedback

## migratetoimage

The **migratetoimage** command migrates data from a volume (image mode) onto a new image mode volume copy. The target disk does not have to be in the same MDisk group (storage pool) as the source disk.

### Syntax

```

▶▶ migratetoimage — [-copy id] — -vdisk [source_vdisk_id | source_vdisk_name]
▶ [-threads number_of_threads] — -mdisk [unmanaged_target_mdisk_id | unmanaged_target_mdisk_name]
▶ [-tier [generic_ssd | generic_hdd]] — -mdiskgrp [managed_disk_group_id | managed_disk_group_name]

```

### Parameters

**-vdisk** *source\_vdisk\_id* | *name*

(Required) Specifies the name or ID of the source volume to be migrated.

**-copy** *id*

(Required if the specified volume has more than one copy) Specifies the volume copy to migrate from.

**-threads** *number\_of\_threads*

(Optional) Specifies the number of threads to use during the migration of extents. You can specify 1 - 4 threads. The default number of threads is 4.

**-mdisk** *unmanaged\_target\_mdisk\_id* | *name*

(Required) Specifies the name of the MDisk to which the data must be migrated. This disk must be unmanaged and large enough to contain the data of the disk that is being migrated.

**-mdiskgrp** *managed\_disk\_group\_id* | *name*

(Required) Specifies the MDisk group (storage pool) into which the MDisk must be placed, after the migration has completed.

**-tier**

Specifies the tier of the MDisk being added.

## Description

The **migratetoimage** command migrates the data of a user-specified volume by consolidating its extents (which might reside on one or more MDisks) onto the extents of the target MDisk that you specify. After migration is complete, the volume is classified as an image type volume, and the corresponding mdisk is classified as an image mode MDisk.

The managed disk that is specified as the target must be in an unmanaged state at the time that the command is run. Running this command results in the inclusion of the MDisk into the user-specified MDisk (storage pool) group.

The **migratetoimage** command fails if the target or source volume is offline. Correct the offline condition before attempting to migrate the volume.

The following example specifies that the user wants to migrate the data from vdisk1 onto mdisk5 and that the MDisk must be put into the MDisk group (storage pool) mdgrp2.

### An invocation example

```
migratetoimage -vdisk vdisk1 -mdisk mdisk5 -tier generic_ssd -mdiskgrp mdgrp2
```

### The resulting output

No feedback

---

## migratevdisk

The **migratevdisk** command enables you to migrate an entire virtual disk from one managed disk group to another managed disk group.

### Syntax

```
➤ migratevdisk -- -mdiskgrp mdisk_group_id | mdisk_group_name [-threads number_of_threads]
```

```
➤ [-copy id] -vdisk vdisk_id | vdisk_name
```

### Parameters

**-mdiskgrp** *mdisk\_group\_id* | *mdisk\_group\_name*

(Required) Specifies the new managed disk group ID or name.

**-threads** *number\_of\_threads*

(Optional) Specifies the number of threads to use during the migration of these extents. You can specify 1 - 4 threads. The default number of threads is 4.

**-copy** *id*

(Required if the specified VDisk has more than one copy) Specifies the VDisk copy to migrate.

**-vdisk** *vdisk\_id* | *vdisk\_name*

(Required) Specifies the virtual disk ID or name to migrate in to a new managed disk group.

## Description

The **migratevdisk** command migrates the specified virtual disk into a new managed disk group; all the extents that make up the virtual disk are migrated onto free extents in the new managed disk group.

You can issue the **lsmigrate** command to view the progress of the migration.

The process can be prioritized by specifying the number of threads to use during the migration. Using only one thread puts the least background load on the system.

The **migratevdisk** command fails if there are insufficient free extents on the targeted managed disk group for the duration of the command. To avoid this problem, do not issue new commands that use extents until the VDisk migration is completed.

The **migratevdisk** command fails if the target VDisk or source VDisk is offline. Correct the offline condition before attempting to migrate the VDisk.

### An invocation example

```
migratevdisk -vdisk 4 -mdiskgrp Group0 -threads 2
```

### The resulting output

No feedback



---

## Chapter 23. Service information commands

Service information commands are used to view the status of the hardware and report hardware errors.

---

### lscmdstatus

Use the **lscmdstatus** command to display the status of any currently running service-aid task.

#### Syntax

```
▶▶ sainfo -- lscmdstatus panel_name ▶▶
```

#### Parameters

*panel\_name*

The name of the panel. This command will fail if the *panel\_name* ID is not in the list returned by **lsservicenodes**.

#### Description

This command displays the status of any currently running service-aid task. If no task is running, then the completion status of the last task will be displayed.

If no service-aid tasks have run since the node was last restarted, the command will return immediately with no output. Otherwise, it will display something similar to the following:

```
Backup date 20100706 15:53 : quorum time 20100706 16:24
```

---

### lsfiles

Use the **lsfiles** command to display the files on the node that you want to retrieve with the **satask cpfiles** command.

#### Syntax

```
▶▶ sainfo -- lsfiles -- -prefix path panel_name ▶▶
```

#### Parameters

*panel\_name*

The name of the panel. The command will fail if the *panel\_name* ID is not in the list returned by the **lsservicenodes** command.

**-prefix** *path*

The path must exist in a permitted listable directory. You can use the following **-prefix** paths:

- /dumps (the default if **-prefix** is not set)
- /dumps/audit
- /dumps/cimom
- /dumps/configs
- /dumps/drive

- /dumps/elogs
- /dumps/enclosure
- /dumps/feature
- /dumps/iostats
- /dumps/iotrace
- /dumps/mdisk
- /dumps/syslogs
- /home/admin/upgrade

## Description

This command displays a list of the files on the node that you want to retrieve using the **satask cpfiles** command.

```
filename
sublun.trc.old
sublun.trc
100050.trc.old
eccore.100050.100305.183051
eccore.100050.100305.183052
ethernet.100050.trc
100050.trc
```

---

## lshardware

The **lshardware** command enables you to view the configured and actual hardware configuration of a node in the cluster.

## Syntax

```
▶▶ — sainfo — lshardware — [-delim — delimiter] [panel_name] ▶▶
```

## Parameters

### **-delim** *delimiter*

(Optional) By default in a concise view, all columns of data are space-separated. The width of each column is set to the maximum possible width of each item of data. In a detailed view, each item of data has its own row, and if the headers are displayed the data is separated from the header by a space. The **-delim** parameter overrides this behavior. Valid input for the **-delim** parameter is a one-byte character. If you enter **-delim :** on the command line, the colon character (:) separates all items of data in a concise view; for example, the spacing of columns does not occur. In a detailed view, the data is separated from its header by the specified delimiter.

### *panel\_name*

(Optional) The node panel name.

## Description

When the node is in a service state, use this command to view the current hardware configuration. Table 49 on page 355 provides the possible values that are applicable to the attributes that are displayed as data in the output views.

Table 49. Ishardware attribute values

| Attribute          | Value                                                                     |
|--------------------|---------------------------------------------------------------------------|
| panel_name         | The node panel name.                                                      |
| node_id            | The node unique ID; blank if not in a clustered system.                   |
| node_name          | The node name; blank if not in a clustered system.                        |
| node_status        | The node status.                                                          |
| hardware           | The hardware model.                                                       |
| actual_different   | Indicates if the node hardware is different than the configured hardware. |
| actual_valid       | Indicates if the node hardware is valid.                                  |
| memory_configured  | The configured amount of memory (in GB).                                  |
| member_actual      | The currently installed amount of memory (in GB).                         |
| memory_valid       | Indicates if the actual memory is a valid configuration.                  |
| cpu_count          | The maximum number of CPUs for the node.                                  |
| cpu_socket         | The ID of socket to which the CPU fields refer.                           |
| cpu_configured     | The configured CPU for this socket.                                       |
| cpu_actual         | The currently installed CPU in this socket.                               |
| cpu_valid          | Indicates if the currently installed CPU is a valid configuration.        |
| adapter_count      | The maximum number of adapters for the node (differs by node type).       |
| adapter_location   | The location of this adapter.                                             |
| adapter_configured | The configured adapter for this location.                                 |
| adapter_actual     | The currently installed adapter for this location.                        |
| adapter_valid      | Indicates if the adapter in this location is valid.                       |

### Sample output for an 8A4 node

```

panel_name 123456
node_id
node_name
status,service
hardware,8A4
actual_different,yes
actual_valid,no
memory_configured,8
memory_actual,8
memory_valid,yes
cpu_count 2
cpu_socket 1
cpu_configured,4 core Intel(R) Xeon(R) CPU E3110 @ 3.0GHz
cpu_actual,4 core Intel(R) Xeon(R) CPU E3110 @ 3.0GHz
cpu_valid,yes
cpu_socket 2
cpu_configured,none
cpu_actual,none
cpu_valid,yes
adapter_count,4
adapter_location,0
adapter_configured,1Gb/s Ethernet adapter
adapter_actual,1Gb/s Ethernet adapter
adapter_valid,yes
adapter_location,0
adapter_configured,1Gb/s Ethernet adapter
adapter_actual,1Gb/s Ethernet adapter
adapter_valid,yes

```

```
adapter_location,1
adapter_configured,Four port 8Gb/s FC adapter card
adapter_actual,Four port 8Gb/s FC adapter card
adapter_valid,yes
adapter_location,2
adapter_configured,none
adapter_actual,Four port 8Gb/s FC adapter card
adapter_valid,no
adapter_location,
adapter_configured,
adapter_actual,
adapter_valid,
adapter_location,
adapter_configured,
adapter_actual,
adapter_valid,
```

### Sample output for a 300 node

```
panel_name 123456
node_id,
node_name,
status,service
hardware,300
actual_different,no
actual_valid,yes
memory_configured,8
memory_actual,8
memory_valid,yes
cpu_count,1
cpu_socket,1
cpu_configured,4 core Intel(R) Xeon(R) CPU E3110 @ 3.0GHz
cpu_actual,4 core Intel(R) Xeon(R) CPU E3110 @ 3.0GHz
cpu_valid,yes
cpu_socket,
cpu_configured,
cpu_actual,
cpu_valid,
adapter_count,6
adapter_location,0
adapter_configured,1Gb/s Ethernet adapter
adapter_actual,1Gb/s Ethernet adapter
adapter_valid,yes
adapter_location,0
adapter_configured,1Gb/s Ethernet adapter
adapter_actual,1Gb/s Ethernet adapter
adapter_valid,yes
adapter_location,0
adapter_configured,Four port 8Gb/s FC adapter card
adapter_actual,Four port 8Gb/s FC adapter card
adapter_valid,yes
adapter_location,0
adapter_configured,High-speed SAS adapter
adapter_actual,High-speed SAS adapter
adapter_valid,yes
adapter_location,0
adapter_configured,Midplane bus adapter
adapter_actual,Midplane bus adapter
adapter_valid,yes
adapter_location,1
adapter_configured,Two port 10Gb/s ethernet adapter
adapter_actual,Two port 10Gb/s ethernet adapter
adapter_valid,yes
```

---

## Isservicenodes

Use the **Isservicenodes** command to displays a list of all the nodes that can be serviced using the service assistant CLI.

### Syntax

▶— `sainfo` — — `Isservicenodes` —————▶

### Parameters

None

### Description

This command displays a list of all the nodes that can be serviced using the service assistant CLI. This list includes nodes that at a code level of at least 6.2.0, are visible on the fabric, and are one of the following:

- The partner node in a control enclosure to the node that is running the command.
- In the same clustered system as the node running the command.
- In candidate state.
- Not in a clustered system and in service state.
- Not in an enclosure with a stored clustered system ID (which is not the clustered system ID of the local node).

Nodes not clustered with the local node will not be shown unless they are the partner node. Table 50 shows possible outputs.

*Table 50. Isservicenodes outputs*

| Attribute    | Value                                                                                                                                                                                                                                                                                                                                                                                         |
|--------------|-----------------------------------------------------------------------------------------------------------------------------------------------------------------------------------------------------------------------------------------------------------------------------------------------------------------------------------------------------------------------------------------------|
| panel_name   | The front panel name, enclosure IDs, or canister IDs that identify the node.                                                                                                                                                                                                                                                                                                                  |
| cluster_id   | Blank if node is a candidate; otherwise, the value is determined from vpd_cluster.                                                                                                                                                                                                                                                                                                            |
| cluster_name | Blank if node is a candidate; otherwise, the value is determined from vpd_cluster.                                                                                                                                                                                                                                                                                                            |
| node_id      | Blank if node is a candidate; otherwise, the value is determined from vpd_cluster.                                                                                                                                                                                                                                                                                                            |
| node_name    | Blank if node is a candidate; otherwise, the value is determined from vpd_cluster.                                                                                                                                                                                                                                                                                                            |
| relation     | <ul style="list-style-type: none"><li>• Local: the node the CLI command was issued from.</li><li>• Partner: the node in the same enclosure as the local node.</li><li>• Cluster: nodes other than the partner that are in the same clustered system as the local node.</li><li>• Candidate: the node is not part of the clustered system.</li></ul>                                           |
| node_status  | <ul style="list-style-type: none"><li>• Active: the node is part of a clustered system and can perform I/O.</li><li>• Service: the node is in service, standby, or node rescue.</li><li>• Candidate: the node is not part of a clustered system.</li><li>• Starting: the node is part of a clustered system and is attempting to join the clustered system, and cannot perform I/O.</li></ul> |
| error_data   | Outstanding error and error data, by priority.                                                                                                                                                                                                                                                                                                                                                |

**Storwize® V7000:** This command displays a list of all the nodes that can be serviced using the service assistant CLI. This list includes nodes that at a code level of at least 6.2.0, are visible on the fabric, and are one of the following:

- The partner node in a control enclosure to the node that is running the command.
- In the same clustered system as the node running the command.
- In candidate state.
- Not in a clustered system and in service state.
- Not in an enclosure with a stored clustered system ID (which is not the clustered system ID of the local node).

Nodes not clustered with the local node will not be shown unless they are the partner node. Table 51 shows possible outputs.

*Table 51. lsservicenodes outputs*

| Attribute    | Value                                                                                                                                                                                                                                                                                                                                                                                              |
|--------------|----------------------------------------------------------------------------------------------------------------------------------------------------------------------------------------------------------------------------------------------------------------------------------------------------------------------------------------------------------------------------------------------------|
| panel_name   | The front panel name, enclosure IDs, or canister IDs that identify the node.                                                                                                                                                                                                                                                                                                                       |
| cluster_id   | Blank if node is a candidate; otherwise, the value is determined from vpd_cluster.                                                                                                                                                                                                                                                                                                                 |
| cluster_name | Blank if node is a candidate; otherwise, the value is determined from vpd_cluster.                                                                                                                                                                                                                                                                                                                 |
| node_id      | Blank if node is a candidate; otherwise, the value is determined from vpd_cluster.                                                                                                                                                                                                                                                                                                                 |
| node_name    | Blank if node is a candidate; otherwise, the value is determined from vpd_cluster.                                                                                                                                                                                                                                                                                                                 |
| relation     | <ul style="list-style-type: none"> <li>• Local: the node the CLI command was issued from.</li> <li>• Partner: the node in the same enclosure as the local node.</li> <li>• Cluster: nodes other than the partner that are in the same clustered system as the local node.</li> <li>• Candidate: the node is not part of a clustered system.</li> </ul>                                             |
| node_status  | <ul style="list-style-type: none"> <li>• Active: the node is part of a clustered system and can perform I/O.</li> <li>• Service: the node is in service, standby, or node rescue.</li> <li>• Candidate: the node is not part of a clustered system.</li> <li>• Starting: the node is part of a clustered system and is attempting to join the clustered system, and cannot perform I/O.</li> </ul> |
| error_data   | Outstanding error and error data, by priority.                                                                                                                                                                                                                                                                                                                                                     |
| candidate    | The candidate for the node. If this option is selected, the cluster_id, cluster_name, node_id and node_name must be blank.                                                                                                                                                                                                                                                                         |

### An invocation example

```
sainfo lsservicenodes
```

### The resulting output

```
panel_name cluster_id cluster_name node_id node_name relation node_status error_data
01-1 0000020073C0A0D4 Cluster_9.180.28.82 1 node1 local Active
1107812-1
```

---

## lsservicerecommendation

Use the **lsservicerecommendation** command to determine what actions should be performed when servicing a node.

## Syntax

```
▶▶ sainfo — — lsservicerecommendation —————▶▶
└──panel_name┘
```

## Parameters

*panel\_name*

(Optional) If no panel ID is provided, the service recommendation for the local node is returned. If a *panel\_name* from the list returned by **lsservicenodes** is specified, then the service recommendation for that node is returned. The command will fail if the *panel\_name* is not in the list returned by **lsservicenodes**.

## Description

This command enables you to determine what actions should be performed when servicing a node.

### Example 1 for service\_action:

Use fabric tools to diagnose and correct Fibre Channel fabric problem.

### Example 2 for service\_action

No service action required, use console to manage node.

---

## lsservicestatus

Use the **lsservicestatus** command to display the current status of a node.

## Syntax

```
▶▶ sainfo — — lsservicestatus —————▶▶
└──panel_name┘
```

## Parameters

*panel\_name*

If a *panel\_name* is provided, the service recommendation for the local node is returned. If a *panel\_name* from the list returned by **lsservicenodes** is specified, then the service recommendation for that node is returned. The command will fail if the *panel\_name* ID is not in the list returned by **lsservicenodes**. This output will also be returned as the node status on all USB flash drive commands.

## Description

Use this command to display the current status of a node. This command provides all the information that can be obtained using the front panel of a SAN Volume Controller node. You can run this command on any node, even one that is not part of a cluster, to obtain the VPD and error status.

Table 52 shows possible outputs.

Table 52. *lsservicestatus* output

| Attribute  | Value                                                                        |
|------------|------------------------------------------------------------------------------|
| panel_name | The front panel name, enclosure IDs, or canister IDs that identify the node. |
| cluster_id | Specifies the ID of a cluster.                                               |

Table 52. *Isservicestatus* output (continued)

| Attribute            | Value                                                                                                                                                                                                                                                                                                                                                                                                         |
|----------------------|---------------------------------------------------------------------------------------------------------------------------------------------------------------------------------------------------------------------------------------------------------------------------------------------------------------------------------------------------------------------------------------------------------------|
| cluster_name         | Specifies the name of a cluster. When you use this parameter, the detailed view of the specific cluster is displayed and any value that you specified by the <b>-filtervalue</b> parameter is ignored. If you do not specify the <i>cluster_name</i> parameter, the concise view of all clusters that match the filtering requirements that are specified by the <b>-filtervalue</b> parameter are displayed. |
| cluster_status       | The error code is the same as the one displayed on the front panel.                                                                                                                                                                                                                                                                                                                                           |
| cluster_ip_count     | The maximum number of management addresses you can configure.                                                                                                                                                                                                                                                                                                                                                 |
| cluster_ip_port      | This, and fields down to <i>prefix_6</i> , are repeated for each management address.                                                                                                                                                                                                                                                                                                                          |
| cluster_ip           | The IPv4 management IP address.                                                                                                                                                                                                                                                                                                                                                                               |
| cluster_gw           | The IPv4 management IP gateway.                                                                                                                                                                                                                                                                                                                                                                               |
| cluster_mask         | The IPv4 management IP mask.                                                                                                                                                                                                                                                                                                                                                                                  |
| cluster_ip_6         | The IPv6 management IP address.                                                                                                                                                                                                                                                                                                                                                                               |
| cluster_gw_6         | The IPv6 management IP gateway.                                                                                                                                                                                                                                                                                                                                                                               |
| cluster_prefix_6     | The IPv6 management IP prefix.                                                                                                                                                                                                                                                                                                                                                                                |
| node_id              | The ID of the node that is being configured.                                                                                                                                                                                                                                                                                                                                                                  |
| node_name            | The name of the node that is being configured.                                                                                                                                                                                                                                                                                                                                                                |
| node_status          | active   starting   service   candidate                                                                                                                                                                                                                                                                                                                                                                       |
| config_node          | yes   no                                                                                                                                                                                                                                                                                                                                                                                                      |
| hardware             | 8F2   8F4   8G4   CF8   8A4   other                                                                                                                                                                                                                                                                                                                                                                           |
| service_IP_address   | The IPv4 service address for the node.                                                                                                                                                                                                                                                                                                                                                                        |
| service_gateway      | The IPv4 service gateway for the node.                                                                                                                                                                                                                                                                                                                                                                        |
| service_subnet_mask  | The IPv4 service mask for the node.                                                                                                                                                                                                                                                                                                                                                                           |
| service_IP_address_6 | The IPv6 service address for the node.                                                                                                                                                                                                                                                                                                                                                                        |
| service_gateway_6    | The IPv6 service gateway for the node.                                                                                                                                                                                                                                                                                                                                                                        |
| service_prefix_6     | The IPv6 service gateway for the node.                                                                                                                                                                                                                                                                                                                                                                        |
| node_sw_version      | The software version of the node.                                                                                                                                                                                                                                                                                                                                                                             |
| node_sw_build        | The build string for software on the node.                                                                                                                                                                                                                                                                                                                                                                    |
| cluster_sw_build     | The CSM build that the cluster is running.                                                                                                                                                                                                                                                                                                                                                                    |
| node_error_count     | The number of node errors.                                                                                                                                                                                                                                                                                                                                                                                    |
| node_error_data      | The type of node errors.                                                                                                                                                                                                                                                                                                                                                                                      |
| FC_port_count        | The number of Fibre Channel ports.                                                                                                                                                                                                                                                                                                                                                                            |
| FC_port_id           | The beginning of repeating fields for each Fibre Channel port; the whole set of fields indicated is repeated for each port.                                                                                                                                                                                                                                                                                   |
| port_status          | This should match the port on the front panel, enclosure, or canister.                                                                                                                                                                                                                                                                                                                                        |
| port_speed           | This should match the port speed on the front panel, enclosure, or canister.                                                                                                                                                                                                                                                                                                                                  |
| port_WWPN            | The worldwide port number of the port.                                                                                                                                                                                                                                                                                                                                                                        |
| SFP_type             | long-wave   short-wave                                                                                                                                                                                                                                                                                                                                                                                        |
| ethernet_port_count  | The number of detected Ethernet ports.                                                                                                                                                                                                                                                                                                                                                                        |
| ethernet_port_id     | Specifies the ID of an Ethernet port.                                                                                                                                                                                                                                                                                                                                                                         |
| port_status          | online   offline   not configured                                                                                                                                                                                                                                                                                                                                                                             |
| port_speed           | 10Mbps   100Mbps   1Gbps   10Gbps   full   half                                                                                                                                                                                                                                                                                                                                                               |



Table 52. *Isservicestatus* output (continued)

| Attribute               | Value                                                                              |
|-------------------------|------------------------------------------------------------------------------------|
| MAC                     | A single MAC address.                                                              |
| product_mtm             | The machine type and model.                                                        |
| product_serial          | The node serial number.                                                            |
| time_to_charge          | The estimated start time (in minutes) needed for 50% of the battery to be charged. |
| battery_charging        | The percentage of charge of the batteries.                                         |
| disk_WWNN_prefix        | The most recently used WWNN prefix.                                                |
| node_WWNN               | N/A                                                                                |
| enclosure_WWNN_1        | N/A                                                                                |
| enclosure_WWNN_2        | N/A                                                                                |
| node_part_identity      | N/A                                                                                |
| node_FRU_part           | N/A                                                                                |
| enclosure_part_identity | N/A                                                                                |
| PSU_count               | N/A                                                                                |
| PSU_id                  | N/A                                                                                |
| PSU_status              | N/A                                                                                |
| battery_count           | N/A                                                                                |
| battery_id              | N/A                                                                                |
| battery_status          | N/A                                                                                |

**Storwize® V7000:** Table 53 shows possible outputs.

**Note:** On a node that is not part of a cluster, some of the fields will be blank or N/A.

Table 53. *Isservicestatus* output

| Attribute        | Value                                                                                                                                                                                                                                                                                                                                                                                                         |
|------------------|---------------------------------------------------------------------------------------------------------------------------------------------------------------------------------------------------------------------------------------------------------------------------------------------------------------------------------------------------------------------------------------------------------------|
| panel_name       | The front panel name, enclosure IDs, or canister IDs that identify the node.                                                                                                                                                                                                                                                                                                                                  |
| cluster_id       | Specifies the ID of a cluster.                                                                                                                                                                                                                                                                                                                                                                                |
| cluster_name     | Specifies the name of a cluster. When you use this parameter, the detailed view of the specific cluster is displayed and any value that you specified by the <b>-filtervalue</b> parameter is ignored. If you do not specify the <i>cluster_name</i> parameter, the concise view of all clusters that match the filtering requirements that are specified by the <b>-filtervalue</b> parameter are displayed. |
| cluster_status   | The error code is the same as the one displayed on the front panel.                                                                                                                                                                                                                                                                                                                                           |
| cluster_ip_count | The maximum number of management addresses you can configure.                                                                                                                                                                                                                                                                                                                                                 |
| cluster_ip_port  | This, and fields down to <i>prefix_6</i> , are repeated for each management address.                                                                                                                                                                                                                                                                                                                          |
| cluster_ip       | The IPv4 management IP address.                                                                                                                                                                                                                                                                                                                                                                               |
| cluster_gw       | The IPv4 management IP gateway.                                                                                                                                                                                                                                                                                                                                                                               |
| cluster_mask     | The IPv4 management IP mask.                                                                                                                                                                                                                                                                                                                                                                                  |
| cluster_ip_6     | The IPv6 management IP address.                                                                                                                                                                                                                                                                                                                                                                               |
| cluster_gw_6     | The IPv6 management IP gateway.                                                                                                                                                                                                                                                                                                                                                                               |
| cluster_prefix_6 | The IPv6 management IP prefix.                                                                                                                                                                                                                                                                                                                                                                                |
| node_id          | The ID of the node that is being configured.                                                                                                                                                                                                                                                                                                                                                                  |

Table 53. Isservicestatus output (continued)

| Attribute               | Value                                                                                                                       |
|-------------------------|-----------------------------------------------------------------------------------------------------------------------------|
| node_name               | The name of the node that is being configured.                                                                              |
| node_status             | active   starting   service   candidate                                                                                     |
| config_node             | yes   no                                                                                                                    |
| hardware                | 8F2   8F4   8G4   CF8   8A4   other                                                                                         |
| service_IP_address      | The IPv4 service address for the node.                                                                                      |
| service_gateway         | The IPv4 service gateway for the node.                                                                                      |
| service_subnet_mask     | The IPv4 service mask for the node.                                                                                         |
| service_IP_address_6    | The IPv6 service address for the node.                                                                                      |
| service_gateway_6       | The IPv6 service gateway for the node.                                                                                      |
| service_prefix_6        | The IPv6 service gateway for the node.                                                                                      |
| node_sw_version         | The software version of the node.                                                                                           |
| node_sw_build           | The build string for software on the node.                                                                                  |
| cluster_sw_build        | The CSM build that the cluster is running.                                                                                  |
| node_error_count        | The number of node errors.                                                                                                  |
| node_error_data         | The type of node errors.                                                                                                    |
| FC_port_count           | The number of Fibre Channel ports.                                                                                          |
| FC_port_id              | The beginning of repeating fields for each Fibre Channel port; the whole set of fields indicated is repeated for each port. |
| port_status             | This should match the port on the front panel, enclosure, or canister.                                                      |
| port_speed              | This should match the port speed on the front panel, enclosure, or canister.                                                |
| port_WWPN               | The worldwide port number of the port.                                                                                      |
| SFP_type                | long-wave   short-wave                                                                                                      |
| ethernet_port_count     | The number of detected Ethernet ports.                                                                                      |
| ethernet_port_id        | Specifies the ID of an Ethernet port.                                                                                       |
| port_status             | online   offline   not configured                                                                                           |
| port_speed              | 10Mbps   100Mbps   1Gbps   10Gbps   full   half                                                                             |
| MAC                     | A single MAC address.                                                                                                       |
| product_mtm             | The machine type and model.                                                                                                 |
| product_serial          | The node serial number.                                                                                                     |
| time_to_charge          | The estimated start time (in minutes) needed for 50% of the battery to be charged.                                          |
| battery_charging        | The percentage of charge of the batteries.                                                                                  |
| node_WWNN               | The last active WWNN stored in the node; blank if no cluster data.                                                          |
| enclosure_WWNN_1        | Canister 1 WWNN from the enclosure VPD.                                                                                     |
| enclosure_WWNN_2        | Canister 2 WWNN from the enclosure VPD.                                                                                     |
| node_part_identity      | The I1S string from the hardware VPD.                                                                                       |
| node_FRU_part           | if stored in node VPD                                                                                                       |
| enclosure_part_identity | The S11 data.                                                                                                               |
| PSU_count               | The number of expected PSUs (two).                                                                                          |
| PSU_id                  | The ID of the slot the PSU is in.                                                                                           |
| PSU_status              | missing   failed   active                                                                                                   |

Table 53. *Isservicestatus* output (continued)

| Attribute                | Value                                                                                                                           |
|--------------------------|---------------------------------------------------------------------------------------------------------------------------------|
| battery_count            | The number of expected batteries (two).                                                                                         |
| battery_id               | The ID of the slot the battery is in.                                                                                           |
| battery_status           | missing   failed   charging   active                                                                                            |
| node_location_copy       | Equivalent to the panel name; blank if a node has been removed from a cluster.                                                  |
| node_product_mtm_copy    | Equivalent to panel product_mtm; blank if a node has been removed from a cluster.                                               |
| node_product_serial_copy | Equivalent to product_serial; blank if a node has been removed from a cluster.                                                  |
| node_WWNN_1_copy         | Equivalent to enclosure_WWNN_1; blank if a node has been removed from a cluster.                                                |
| node_WWNN_2_copy         | Equivalent to enclosure_WWNN_2; blank if a node has been removed from a cluster.                                                |
| latest_cluster_id        | The cluster ID running on the current enclosure; blank if a node has been removed from a cluster.                               |
| next_cluster_id          | The cluster ID that will be used to create the next cluster on this enclosure; blank if a node has been removed from a cluster. |



---

## Chapter 24. Service mode commands (Discontinued)

**Attention:** The service mode commands are discontinued.

---

### **applysoftware (Discontinued)**

**Attention:** The `svcservicemodetask applysoftware` command is discontinued. Use the `satask installsoftware` command instead.

Discontinued.

---

### **cleardumps (Discontinued)**

**Attention:** The `svcservicemodetask cleardumps` command is discontinued.

---

### **dumperrlog (Discontinued)**

**Attention:** The `svcservicemodetask dumperrlog` command is discontinued.

---

### **exit (Discontinued)**

**Attention:** The `svcservicemodetask exit` command is discontinued. Use the `satask stopservice` command instead.



---

## Chapter 25. Service mode information commands (Discontinued)

**Attention:** The service mode information commands are discontinued.

---

### ls2145dumps (Discontinued)

**Attention:** The `svcserviceinfo ls2145dumps` command is discontinued. Use the `svcinfo lsdumps` command to display a list of files in a particular dumps directory.

---

### lscimomdumps (Discontinued)

**Attention:** The `svcserviceinfo lscimomdumps` command is discontinued. Use the `svcinfo lsdumps` command to display a list of files in a particular dumps directory.

---

### lsclustervpd (Discontinued)

**Attention:** The `svcserviceinfo lsclustervpd` command is discontinued. Use the `sainfo lsservicestatus` command instead.

---

### lserrlogdumps (Discontinued)

**Attention:** The `svcserviceinfo lserrlogdumps` command is discontinued. Use the `svcinfo lsdumps` command to display a list of files in a particular dumps directory.

---

### lsfeaturedumps (Discontinued)

**Attention:** The `svcserviceinfo lsfeaturedumps` command is discontinued. Use the `svcinfo lsdumps` command to display a list of files in a particular dumps directory.

---

### lsiostatsdumps (Discontinued)

**Attention:** The `svcserviceinfo lsiostatsdumps` command is discontinued. Use the `svcinfo lsdumps` command to display a list of files in a particular dumps directory.

---

### lsiotracedumps (Discontinued)

**Attention:** The `svcserviceinfo lsiotracedumps` command is discontinued. Use the `svcinfo lsdumps` command to display a list of files in a particular dumps directory.

---

### lsmdiskdumps (Discontinued)

**Attention:** The `svcserviceinfo lsmdiskdumps` command is discontinued. Use the `svcinfo lsdumps` command to display a list of files in a particular dumps directory.

---

### lsnodevpd (Discontinued)

**Attention:** The `svcserviceinfo lsnodevpd` command is discontinued. Use the `svcinfo lsnodevpd` command to display the vital product data (VPD) for each node.

---

## **lssoftwaredumps (Discontinued)**

**Attention:** The `svcserviceinfo lssoftwaredumps` command is discontinued. Use the `svcinfo lsdumps` command to display a list of files in a particular dumps directory.



---

## Chapter 26. Service task commands

Service information commands enable you to service the node hardware.

---

### chenclosurevpd

Use the **chenclosurevpd** command to cause the partner node in the enclosure to warmstart so that it can acquire the changed midplane, and to change fields in the control enclosure VPD.

#### Syntax

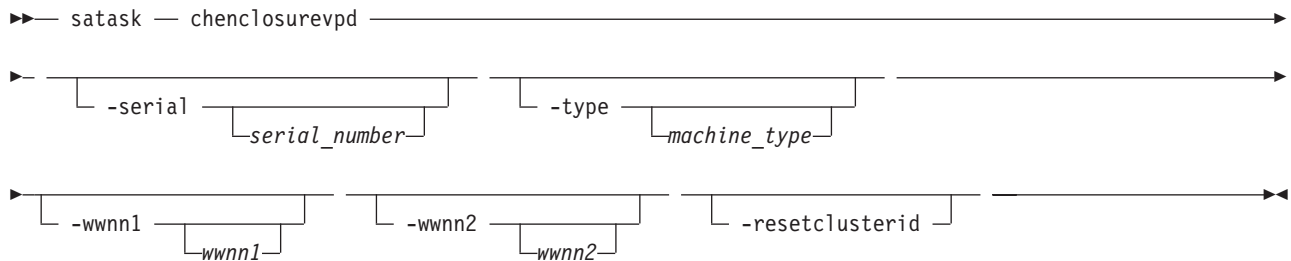

#### Parameters

**-serial** *serial\_number*

(Optional) The new serial number for the enclosure. The *serial\_number* must be set on a replacement enclosure to match the values of the enclosure being replaced.

**-type** *machine\_type*

(Optional) The type of machine. The *machine\_type* must be set on a replacement enclosure to match the values of the enclosure being replaced.

**-wwnn1** *wwnn1*

(Optional) The WWNN of canister 1. The *wwnn1* must be set on a replacement enclosure to match the values of the enclosure being replaced.

**Note:** If you change *wwnn1* on an operating system, you might need to also change the host and Fibre Channel configuration settings.

**-wwnn2** *wwnn2*

(Optional) The WWNN of canister 2. The *wwnn2* must be set on a replacement enclosure to match the values of the enclosure being replaced.

**Note:** If you change *wwnn2* on an operating system, you might need to also change the host and Fibre Channel configuration settings.

**-resetclusterid**

(Optional) Requests the stored cluster to be zeroed.

**Attention:** The cluster ID indicates if the enclosure, and the drives it contains, are part of a cluster. Resetting it indicates it is no longer part of a cluster, and any data required on the drives is not required. This might result in loss of access to your data.

## Description

Use this command to change fields in the control enclosure VPD. The node must be in candidate or service state when you run this command, and cannot be part of a cluster.

### An example of setting the serial number

```
satask chenclosurevpd -serial 123456
```

---

## chnodeled

Use the **chnodeled** command to turn on or off the location LED for the specified canister.

## Syntax

```
▶▶ satask — chnodeled —on | -off—panel_name—————▶▶
```

## Parameters

*on* | *off*

Turns on or off the location LED for the specified canister.

## Description

This command turns on or off the canister location LED.

**Note:** The location LED is mapped onto the physical LEDs using different methods, depending on your hardware. Refer to the documentation for your hardware platform for more information.

### To turn on the LED for canister 1 in enclosure 02:

```
satask chnodeled -on 02-1
```

---

## chserviceip

Use the **chserviceip** command to set the service assistant IP address for a specific node.

## Syntax

```
▶▶ satask — chserviceip — --serviceip—ipv4— [—gw—ipv4—] [—mask—ipv4—] [—resetpassword—] [—panel_name—]—————▶▶
```

```
▶▶ satask — chserviceip — --serviceip_6—ipv6— [—gw_6—ipv6—] [—prefix_6—int—] [—resetpassword—] [—panel_name—]—————▶▶
```

```
▶▶ satask — chserviceip — [—resetpassword—] [—panel_name—]—————▶▶
```

```
▶▶ satask — chserviceip — --dhcp— [—resetpassword—] [—panel_name—]—————▶▶
```

```
▶▶ satask — chserviceip — --dhcp_6— [—resetpassword—] [—panel_name—]—————▶▶
```

## Parameters

### **panel\_name**

(Optional) Identifies the node being serviced.

### **-serviceip**

The IPv4 address for the service assistant.

**Note:** The IPv4 service address can be unconfigured by setting the address to 0.0.0.0.

### **-gw**

The IPv4 gateway for the service assistant.

### **-mask**

The IPv4 subnet for the service assistant.

### **-serviceip\_6**

The IPv6 address for the service assistant.

**Note:** The IPv6 service address can be unconfigured by setting the address to 0:0:0:0:0:0:0:0.

### **-gw\_6**

The IPv6 gateway for the service assistant.

### **-prefix\_6**

The IPv6 prefix for the service assistant.

### **-dhcp**

Attempts to obtain an IPv4 address from DHCP.

### **-dhcp\_6**

Attempts to obtain an IPv6 address from DHCP.

### **-resetpassword**

Sets the service assistant password to default.

## Storwize V7000:

### **-default**

Resets the IPv4 service address of a Storwize V7000 to the default address.

### **panel\_name**

(Optional) Identifies the node being serviced.

### **-serviceip**

The IPv4 address for the service assistant.

**Note:** The IPv4 service address can be unconfigured by setting the address to 0.0.0.0.

### **-gw**

The IPv4 gateway for the service assistant.

### **-mask**

The IPv4 subnet for the service assistant.

### **-serviceip\_6**

The IPv6 address for the service assistant.

**Note:** The IPv6 service address can be unconfigured by setting the address to 0:0:0:0:0:0:0:0.

### **-gw\_6**

The IPv6 gateway for the service assistant.

### **-prefix\_6**

The IPv6 prefix for the service assistant.

### **-resetpassword**

Sets the service assistant password to default.

## **Description**

This command sets the service assistant IP address for a specific node. If the node is part of cluster, then the cluster gateway, subnet and prefix will be used unless specified otherwise. If the node is a candidate node, the subnet, prefix and gateway must be specified. If you specify an IPV4 or IPV6 address, but do not provide a gateway, mask, or prefix, then the existing gateway, mask, and prefix values will be preserved.

### **Input**

```
satask chserviceip
```

### **Input (with a specific -serviceip, -gw, and -mask parameters)**

```
satask chserviceip -serviceip 1.2.3.4 -gw 1.2.3.1 -mask 255.255.255.0
```

---

## **chwwnn**

Use the **chwwnn** command to modify the node World Wide Node Name (WWNN).

### **Syntax**

```
▶▶ satask — chwwnn — — -wwnnsuffix — wwnn_suffix — [-panel_name] ▶▶
```

### **Parameters**

#### **-wwnnsuffix**

(Optional) The suffix to be used for node *wwnn*.

#### **panel\_name**

(Optional) Identifies the node being serviced.

### **Description**

This command modifies the WWNN. Use the **lsservicestatus** command to view suggested WWNNs.

[No feedback]

---

## **cpfiles**

Use the **cpfiles** command to copy files from another node.

### **Syntax**

```
▶▶ satask — cpfiles — -prefix — path — [directory] — -source — source_panel_name —▶▶
[file_filter]
▶▶ [target_panel_name] ▶▶
```

## Parameters

### **-prefix** *path*

Specifies the directory, files, or directory and files to be retrieved. The path must exist in a permitted listable directory. You can use the following **-prefix** filters:

- /dumps (retrieves all files in all subdirectories)
- /dumps/audit
- /dumps/cimom
- /dumps/configs
- /dumps/drive
- /dumps/elogs
- /dumps/enclosure
- /dumps/feature
- /dumps/iostats
- /dumps/iotrace
- /dumps/mdisk
- /dumps/syslogs
- /home/admin/upgrade
- \* /dumps/enclosure

### **Note:**

- You can also specify a file filter. For example, if you specify /dumps/elogs/\*.txt, all files in the /dumps/elogs directory that end in .txt are copied.
- If you use a wildcard, the following rules apply:
  1. The wildcard character is an asterisk (\*).
  2. The command can contain a maximum of one wildcard.
  3. When you use a wildcard, you must surround the filter entry with double quotation marks ("x"). For example: `satask cpfiles -prefix "/dumps/elogs/*.txt"`

### *source\_panel\_name*

Identifies the source node files will be copied from.

### *target\_panel\_name*

Identifies the node that files will be copied to. If no panel name is provided, the files will be copied to the local node.

## Description

This command copies files from another node. You can monitor the progress of the copy using the **sainfo lscmdstatus** command.

### **To get configuration information from canister 1 in enclosure 2:**

```
satask cpfiles -prefix /dumps/configs -source 02-1
```

---

## installsoftware

Use the **installsoftware** command to install a specific software package.

## Syntax

```
▶▶ satask — installsoftware — — -file filename — [-ignore | -pacedccu] [panel_name] ▶▶
```

## Parameters

### panel\_name

(Optional) Identifies the node being serviced.

### -file

The file name of software installation package.

**Note:** The argument to **-file** must be present on the local node; the argument will be automatically copied to the target panel\_name.

### -ignore

Overrides prerequisite checking and forces installation of the software.

### -pacedccu

Causes the node to initiate a paced ccu (in which you define when the node begins its upgrade) instead of a normal ccu (in which each node in the cluster automatically upgrades in sequence).

## Description

This command installs a specific software package.

### An invocation example:

```
satask installsoftware -file install_pkg.gpg nodeB_panel_name
```

---

## leavecluster

Use the **leavecluster** command to remove clustered system (system) state data, location information, and other history from a node.

## Syntax

```
▶▶▶ satask -- leavecluster -- -force -- -panel_name ▶▶▶
```

## Parameters

### -force

**Attention:** The **-force** parameter is required because this service action can cause temporary or permanent loss of access to data. Use this command only when a service procedure instructs you to do so.

### panel\_name

(Optional) Identifies the node being serviced.

## Description

Use this command to remove system state data, location information, and other history from a node.

```
satask leavecluster -force
```

---

## metadata

Use the **metadata** command to recover a virtualization table.

## Syntax

```
▶▶ satask metadata --rebuildcluster
▶▶ satask metadata --scan --file filename_arg --disk UID_arg --start start_arg
▶ [-end end_arg]
▶▶ satask metadata --dump --disk UID_arg --start start_arg
```

## Parameters

### -rebuildcluster

Creates a cluster from the metadata found in `/dumps/t3_recovery.bin` created by the `-dump` process.

### -file

Specifies the file in which you want the results of a scan operation. The file is placed into the node filesystem in the directory `/dumps` and can be retrieved using `scp`. The file can be subsequently cleaned using the `cleandumps` command.

### -disk

Specifies the UID of the MDisk or drive that you want to scan, or remove a dump from. .

### -start

- scan: the LBA at which to start scanning
- dump: the LBA at which the metadata resides (as reported in the scan file)

### -end

The last LBA in which to look for metadata on the disk.

## Description

Use this command to recover a virtualization table.

### An example

```
satask metadata -scan -file scan.0.xml
-disk 600a0b80000f14ee0000008e4146bdee00000000000000000000000000000000 -start 0
```

---

## mkcluster

Use the `mkcluster` command to create a new clustered system.

## Syntax

```
▶▶ satask mkcluster --clusterip --gw --mask
▶ -clusterip_6 --gw_6 --prefix_6 [-name cluster_name] [-panel_name]
```

## Parameters

### -clusterip

The IPv4 address for clustered system Ethernet port 1.

**-gw**  
The IPv4 gateway for clustered system Ethernet port 1.

**-mask**  
The IPv4 subnet for clustered system Ethernet port 1.

**-clusterip\_6**  
The IPv6 address for clustered system Ethernet port 1.

**gw\_6**  
The IPv6 gateway for clustered system Ethernet port 1.

**prefix\_6**  
The IPv6 prefix for clustered system Ethernet port 1.

**name***cluster\_name*  
(Optional) The name of the new clustered system.

**panel\_name**  
(Optional) Identifies the node being serviced.

**Note:** You must specify either an IPv4 clustered system IP, gateway and subnet, or an IPv6 clustered system IP, gateway, and subnet.

## Description

- | This command creates a new clustered system.

### Input

```
satask mkcluster -clusterip ipv4 -gw ipv4 -mask ipv4 [-name cluster_name] [panel_name]
```

### Input (with specific **-clusterip**, **-gw**, and **-mask** parameters)

```
satask mkcluster -clusterip 192.168.1.2 -gw 192.168.1.1 -mask 255.255.255.0
```

---

## rescuenode

Use the **rescuenode** command to start automatic recovery for a specific node.

## Syntax

```
▶▶ satask — rescuenode — — -force — — [-panel_name] ▶▶
```

## Parameters

**panel\_name**  
(Optional) Identifies the node being serviced.

### **-force**

**Attention:** The **-force** parameter is required because this service action can cause temporary or permanent loss of access to data. Use this command only when the node reports corrupted software.

## Description

This command starts automatic recovery for a specific node. Use this command only when the node reports corrupted software.

```
satask rescuenode -force 112233
```



---

## resetleds

Use the **resetleds** command to simultaneously switch off all LEDs in the cluster.

### Syntax

▶▶ resetleds ◀◀

### Parameters

None.

### Description

The command simultaneously switches off all LEDs in the cluster. This ensures that, when an identity LED is switched on, it is the only one in the cluster. This command works only on LEDs on devices that can be communicated with; it will fail if an object is offline or if the enclosure is an unsupported type. Some LEDs are not affected by this command (for example, LEDs on independently controlled objects, LEDs with hardware-only controls, or LEDs on offline objects).

resetleds

---

## resetpassword

Use the **resetpassword** command to reset the clustered system (system) superuser password to *password*.

### Syntax

▶▶ satask — resetpassword — ◀◀

### Parameters

None.

### Description

This command resets the system superuser password to *password*. The next time you log in to the GUI, you will be prompted for a new password.

No feedback

---

## restartservice

Use the **restartservice** command to restart a named service.

### Syntax

▶▶ satask — restartservice — -service — *service\_name* — *panel\_name* ◀◀

### Parameters

-service *service\_name*

Specifies the name of the service that you want to restart. The following services are supported:

| `sshd`  
 | Secure Shell Daemon

| `slpd`  
 | Service Location Protocol Daemon

| `easy`  
 | Easy Tier

| `tomcat`  
 | Web server

| `cimom`  
 | CIMOM

| `panel_name`  
 | Identifies the node being serviced.

## | Description

| When directed to do so by IBM support, use this command to restart a named service.

### | An example of restarting cimom

| `satask restartservice -service cimom`

---

## snap

Use the **snap** command to create a snap file on the node that you specify.

## Syntax

►► `satask -- snap` -dump -panel\_name \_\_\_\_\_ ►►

## Parameters

**-dump**  
 (Optional) Collects the existing dump.

**panel\_name**  
 (Optional) Identifies the node being serviced.

## Description

This command creates a snap file on the node that you specify.

The name of the output file is `snap.single.nodeid.date.time.tgz`.

---

## setpacedccu

Use the **setpacedccu** command to flag a node to participate in a user-paced concurrent code upgrade.

## Syntax

►► `satask -- setpacedccu` panel\_name \_\_\_\_\_ ►►

## Parameters

**panel\_name**  
(Optional) Identifies the node being serviced.

## Description

Use this command to flag a node to participate in a user-paced concurrent code upgrade. This command can only be used when the node is:

- In a service state
- Error-free
- Not part of a cluster when the node is out of a service state

[No feedback]

---

## settempsshkey

Use the **settempsshkey** command to install a temporary Secure Shell (SSH) key for a superuser ID to run commands in the service assistant CLI.

## Syntax

```
▶▶ satask — settempsshkey — — -keyfile filename — [-panel_name]
```

## Parameters

**-keyfile *filename***  
Specifies the name of the file that contains the Secure Shell (SSH) public key. The file identified by *filename* must be on the local node (or on the USB flash drive, if you execute the command from there).

**panel\_name**  
(Optional) Identifies the node being serviced.

## Description

This command installs a temporary SSH key for a superuser ID to run commands in the service assistant CLI (for example, to copy files to or from the node).

You can only perform this command when performing a service action. Installing a temporary key will replace any available existing keys. The key will be deleted when the node joins a cluster or is rebooted or power cycled.

[No feedback.]

---

## startservice

Use the **startservice** command to enter a service state.

## Syntax

```
▶▶ satask — startservice — [-force] [-panel_name]
```

## Parameters

### **-force**

(Optional) Overrides checking of clustered system (system) membership.

### **panel\_name**

(Optional) Identifies the node being serviced.

## Description

This command enters a service state. For example, you might use a service state to remove a node from the candidate list, or to prevent it from automatically being added to a system again. The **-force** flag is required if the action could interrupt I/O (last node in cluster or IO group). This command holds the node in service state until it is cleared using the **satask stopservice** command, or until the I/O process is restarted.

## Input

```
satask startservice
```

---

## stopnode

Use the **stopnode** command to power off, reboot, or warmstart a node.

## Syntax

```
▶▶ satask — stopnode — --poweroff | -reboot | -warmstart — panel_name —▶▶
```

## Parameters

### **panel\_name**

(Optional) Identifies the node being serviced.

### **-poweroff**

Powers off the node.

### **-reboot**

Reboots the node.

### **-warmstart**

Restarts the I/O process and issues a diagnostic dump.

## Description

Use this command to power off a node, reboot a node, or restart the I/O process.

### **Powering off canister 1 in enclosure 2:**

```
satask stopnode -poweroff 02-1
```

---

## stopservice

Use the **stopservice** command to exit a service state.

## Syntax

```
▶▶ satask — stopservice — [-panel_name]
```

## Parameters

**panel\_name**  
(Optional) Identifies the node being serviced.

## Description

This command exits a service state entered using the **startservice** command, and exits the service state on the local node.

### Input

```
satask stopservice
```

### Output

```
Node is no longer in service state
```

---

## t3recovery

Use the **t3recovery** command to prepare and start a T3 recovery.

## Syntax

```
▶▶ satask — t3recovery — — -prepare | execute — [-panel_name]
```

## Parameters

**panel\_name**  
(Optional) Identifies the node being serviced.

### -prepare

Search for T3 recovery data. This locates the date of the necessary backup file and quorum disk. You can track the progress of this command using the **sainfo lscmdstatus** command.

### -execute

Start T3 recovery using recovered data.

## Description

This command prepares and starts a T3 recovery.

[No feedback]



---

## Chapter 27. Tracing commands

Tracing commands capture information that can assist you with troubleshooting managed disks and virtual disks.

---

### setdisktrace

Use the **setdisktrace** command to set a list of disks of a given type, to include in a disk trace.

#### Syntax

```
►► — setdisktrace — — -type [mdisk | vdisk] [-set | -reset] [-all | -objectid id_or_name_list]
► [-objectid | -id_or_name_list]
```

#### Parameters

**-type mdisk | vdisk**

(Required) Specifies the object type for the disks.

**-set**

(Optional) Specifies the set argument. You cannot use the **-set** parameter with the **-reset** parameter.

**-reset**

(Optional) Specifies the reset argument. You cannot use the **-set** parameter with the **-reset** parameter.

**-all**

(Optional) Traces all disks of the specified type. You cannot use the **-all** parameter with the **-objectid** parameter.

**-objectid id\_or\_name\_list**

(Optional) Specifies a list of one or more disk IDs or names. You cannot use the **-objectid** parameter with the **-all** parameter.

#### Description

The **setdisktrace** command marks the disks to be included in the next triggered trace.

The command is used with the **settrace** command, which sets the options that result in a trace file and the data that is included in the trace file.

#### An invocation example

```
setdisktrace -type mdisk -objectid
mdisk1:mdisk3:mdisk11:mdisk10:mdisk9:mdisk5 -reset
```

#### The resulting output

No feedback

---

### settrace

The **settrace** command sets options to trace certain I/O operations through the system.

## Syntax

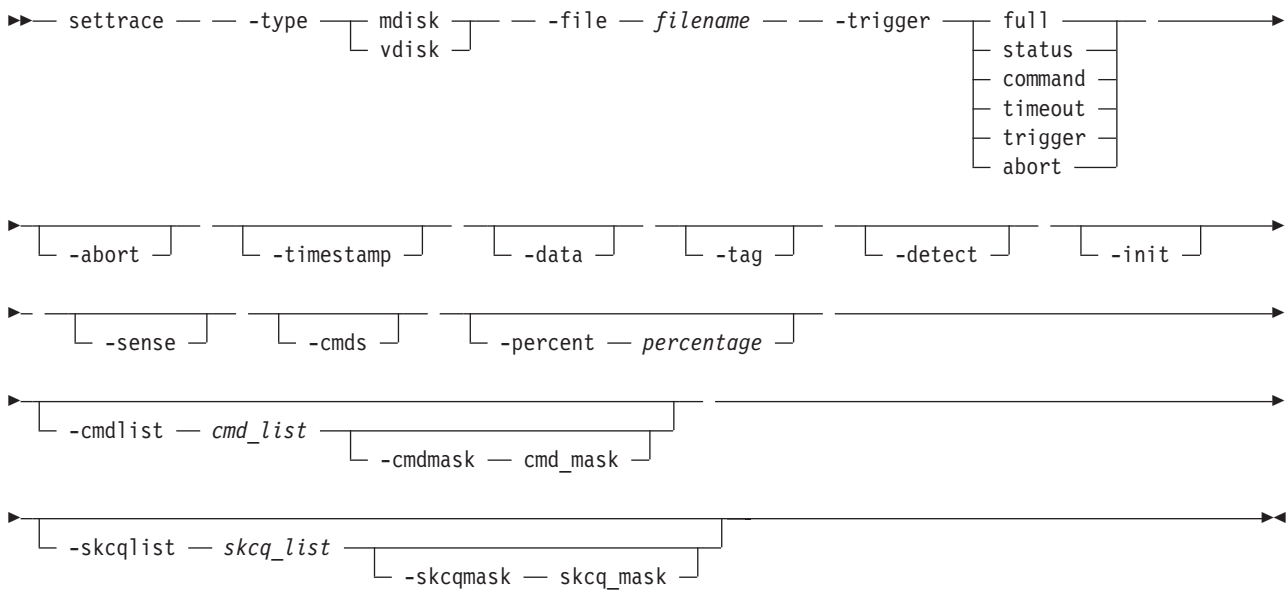

## Parameters

### **-type mdisk | vdisk**

(Required) Specifies the type of objects to trace.

### **-file filename**

(Required) Specifies the file name prefix for the trace file.

### **-trigger full | status | command | timeout | trigger | abort**

(Required) Specifies an action for when the trace is started (triggered).

**full** Specifies to stop the trace when the trace buffer is full, for MDisks and VDIs.

**status** Sets a trigger for when the specified SCSI status (**-skcqlist**) is reported in sense data, for MDisks and VDIs.

#### **command**

Specifies a trigger for when the given SCSI command (**-cmdlist**) is sent, for MDisks and VDIs.

#### **timeout**

Sets a trigger for when a timeout occurs, for MDisks only.

#### **trigger**

Specifies to keep running until the trigger event, for MDisks only.

**abort** Sets a trigger for when an abnormal end occurs, for VDIs only.

### **-abort**

(Optional) Adds abnormal ending details to the trace, for VDIs only.

### **-timestamp**

(Optional) Adds a time-stamp to each entry in the trace. A file name is created from the prefix plus a time-stamp. The file name is in the form *prefix\_AAAAAA\_YYMMDD\_HHMMSS*, where *AAAAAA* is the panel name of the node generating the trace file.

### **-data**

(Optional) Adds I/O data to the trace.



- tag**  
(Optional) Adds CCB tags to the trace, for MDisks only.
- detect**  
(Optional) Adds MDisk discovery details to the trace, for MDisks only.
- init**  
(Optional) Adds MDisk initialization details to the trace, for MDisks only.
- sense**  
(Optional) Adds SCSI sense data to the trace, for VDIs only.
- cmds**  
(Optional) Adds commands data to the trace, for VDIs only.
- percent**  
(Optional) Specifies the trigger point in the trace file, which determines the amount of data to collect after the trigger point. The default value is **50**, which places the trigger point in the middle of the trace file.
- cmdlist *cmd\_list***  
(Optional) Adds the commands in the *cmd\_list* to the trace file.
- cmdmask *cmd\_mask***  
(Optional) Adds the commands in the *cmd\_mask* to the trace file. The **-cmdmask** parameter must be used with the **-cmdlist** parameter.
- skcqlist *skcq\_list***  
(Optional) Specifies an SKCQ list, which adds only those SKCQ details to the trace file.
- skcqmask *skcq\_mask***  
(Optional) Specifies an SKCQ mask, which adds only those SKCQ details to the trace file. The **-skcqmask** parameter must be used with the **-skcqlist** parameter.

## Description

The **settrace** command sets the various I/O tracing options for managed disks or virtual disks. When the relevant disk type trace is subsequently triggered, the options specify the data to be included in the trace file.

The file name specifies a file name prefix to use when you are generating a trace file. The system appends the node panel name and a timestamp to the file name.

A maximum of 10 trace files are kept on the cluster. When the eleventh trace is made, the oldest existing trace file is overwritten.

The directory can also hold files that are retrieved from other nodes. These files are not counted. The cluster deletes the oldest file to maintain the maximum number of files.

### An invocation example

```
settrace -type vdisk -file tracedump -trigger abort
 -percent 100 -abort -timestamp
```

### The resulting output

No feedback

---

## starttrace

Use the **starttrace** command to begin tracing I/O operations that are based on the option currently set for the specified object type and the list of disks to trace.

## Syntax

```
▶▶ starttrace -- -type [mdisk | vdisk]
```

## Parameters

**-type mdisk | vdisk**

Specifies the object type to trigger.

## Description

This command starts the collection of I/O tracing information. The trace file is generated according to the options that you specified in the **settrace** command. The disks that are traced are those that are identified in the list that is set by the **setdisktrace** command.

The traces are written to the **/dumps/iotrace** directory. You can view the contents of this directory using the **lsiotrace** command.

### An invocation example

```
starttrace -type vdisk
```

### The resulting output

No feedback

---

## stoptrace

Use the **stoptrace** command to stop tracing operations for the specified disk type.

## Syntax

```
▶▶ stoptrace -- -type [mdisk | vdisk]
```

## Parameters

**-type mdisk | vdisk**

(Required) Specifies the object type to stop tracing.

## Description

This command stops the tracing of I/O operations for the specified object type. A trace file is not generated if the trigger options have not been met.

### An invocation example

```
stoptrace -type mdisk
```

### The resulting output

No feedback

---

## Chapter 28. User management commands

You can use the command-line interface (CLI) to configure remote authentication service and manage users and user groups on the clustered system.

The following user management commands are available:

### **chauthservice**

Configures the remote authentication service of the clustered system.

### **chcurrentuser**

Changes the attributes of the current user.

**chuser** Changes the attributes of an existing user.

### **chusergrp**

Changes the attributes of an existing user group.

### **lscurrentuser**

Displays the name and role of the logged-in user. See the “*lscurrentuser*” on page 216 command in the Chapter 17, “Information commands,” on page 205 section.

**lsuser** Lists the users who have been created on the system. See the “*lsuser*” on page 288 command in the Chapter 17, “Information commands,” on page 205 section.

### **lsusergrp**

Lists the user groups that have been created on the system. See the “*lsusergrp*” on page 289 command in the Chapter 17, “Information commands,” on page 205 section.

### **mkuser**

Creates either a local or a remote user to access a clustered system.

### **mkusergrp**

Creates a new user group.

### **rmuser**

Removes a user.

### **rmusergrp**

Removes a user group.

---

## **chauthservice**

The **chauthservice** command can be used to configure the remote authentication service of the clustered system (system).

### **Syntax**

```
▶▶ chauthservice — [-enable [yes | no]] [-url url] [-username user_name] [-password password] [-sslcert file_name]
```

┌ -refresh ─┐

## Parameters

### **-enable** *yes* | *no*

(Optional) Enables or disables the SAN Volume Controller system's use of the remote authentication server. When the **enable** parameter is set to *no*, remote authentications are failed by the system, but local authentications continue to operate normally.

### **-url** *url*

(Optional) Specifies the web address of the remote authentication service. This must be a valid IPv4 or IPv6 network address. You can use the following characters: a - z, A - Z, 0 - 9, \_ , ~ , : , [ , ] , % , or / . The maximum length of the web address is 100 characters.

### **-username** *user\_name*

(Optional) Specifies the HTTP basic authentication user name. The user name cannot start or end with a blank. The user name can consist of a string of 1 - 64 ASCII characters with the exception of the following characters: %:"\*'. .

### **-password** *password*

(Optional) Specifies the HTTP basic authentication user password. The password cannot start or end with a blank. It must consist of a string of 6 - 64 printable ASCII characters. The *password* variable is optional. If you do not provide a password, the system prompts you and does not display the password that you type.

### **-sslcert** *file\_name*

(Optional) Specifies the name of the file that contains the SSL certificate, in privacy enhanced mail (PEM) format, for the remote authentication server.

### **-refresh**

(Optional) Causes the SAN Volume Controller to invalidate any remote user authorizations that are cached on the system. Use this when you modify user groups on the authentication service and want the change to immediately take effect on the SAN Volume Controller.

## Description

This command sets the attributes of the remote authentication service on the system. It is not necessary to disable the remote authentication service to change its attributes. To disable the remote authentication service in a controlled manner when it is not available, use the **enable** parameter with the *no* option.

When the authentication service is enabled or the configuration is changed, the system does not test whether the remote authentication system is operating correctly. To establish whether the system is operating correctly, issue the command **!currentuser** for a remotely authenticated user. If the output lists the user roles obtained from the remote authentication server, remote authentication is operating successfully. If the output is an error message, remote authentication is not working correctly, and the error message describes the problem.

If you are using the **url** parameter, the web address can have either of the following formats:

- `http://network_address:http_remote_authentication_service_port_number/path_to_service`
- `https://network_address:https_remote_authentication_service_port_number/path_to_service`

The network address must be an IPv4 or IPv6 address. Do not use the corresponding host name.

For example, if the system network IPv4 address is 9.71.45.108, you could enter either of the following corresponding addresses:

```
http://9.71.45.108:16310/TokenService/services/Trust
https://9.71.45.108:16311/TokenService/services/Trust
```

### An invocation example

To fully configure and enable the authentication service:

```
chauthservice -url https://9.71.45.108:16311/TokenService/services/Trust
-sslcert /tmp/sslCACert.pem -username admin -password password -enable yes
```

### The resulting output

No feedback

### An invocation example

To disable remote authentication:

```
chauthservice -enable no
```

### The resulting output

No feedback

### An invocation example

To switch to an HTTPS connection to the authentication service:

```
chauthservice -url https://9.71.45.108:16311/TokenService/services/Trust
-sslcert /tmp/ssl_cert.pem
```

### The resulting output

No feedback

### An invocation example

To refresh the SAN Volume Controller remote authorization cache:

```
chauthservice -refresh
```

### The resulting output

No feedback

---

## chcurrentuser

The **chcurrentuser** command changes the attributes of the current user.

### Syntax

```
►► chcurrentuser — [-password cleartext_password] [-nokey] [-keyfile sshkey_filename]
```

### Parameters

**-password** *cleartext\_password*

(Optional) Specifies the new password to be associated with the current user. The password cannot start or end with a blank. It must consist of a string of 6 - 64 printable ASCII characters. You can optionally specify the password with the **password** parameter. If you do not specify the password, the system prompts you for it before running the command and does not display the password that you type. Either the **password** parameter or the **nopassword** parameter can be set.

**-nopassword**

(Optional) Specifies that the user's password is to be deleted.

**-keyfile *sshkey\_filename***

(Optional) Specifies the name of the file that contains the Secure Shell (SSH) public key. Either the **keyfile** parameter or the **nokey** parameter can be set.

**-nokey**

(Optional) Specifies that the user's SSH key is to be deleted.

## Description

Use the **chcurrent user** command to modify the attributes of the current user.

### An invocation example

```
chcurrentuser -password secret -nokey
```

### The resulting output

No feedback

## chuser

The **chuser** command changes the attributes of an existing user.

### Syntax

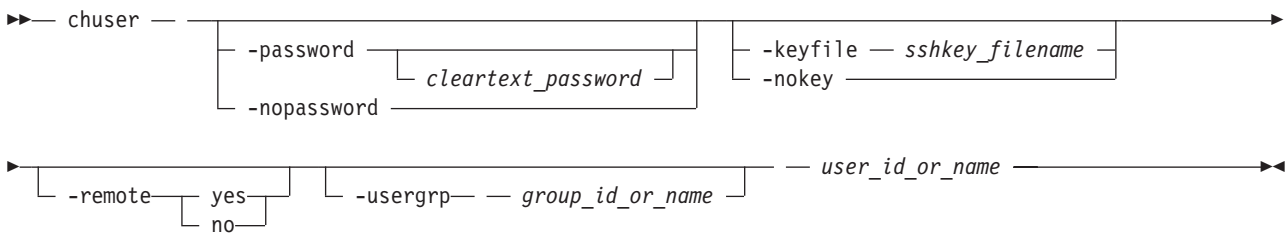

### Parameters

**-password *cleartext\_password***

(Optional) Specifies the new password to be associated with the user. The password cannot start or end with a blank. It must consist of a string of 6 - 64 printable ASCII characters. You can optionally specify the password with the **password** parameter. If you do not specify the password, the system prompts you for it before running the command and does not display the password that you type. Either the **password** parameter or the **nopassword** parameter can be set.

**-nopassword**

(Optional) Specifies that the user's password is to be deleted.

**-keyfile *sshkey\_filename***

(Optional) Specifies the name of the file that contains the Secure Shell (SSH) public key. Either the **keyfile** parameter or the **nokey** parameter can be set.

**-nokey**

(Optional) Specifies that the user's SSH key is to be deleted.

**-remote yes | no**

(Optional) Specifies whether the user authenticates to the cluster using a remote authentication service. Either the yes or no option must be set.

**-usergrp** *group\_id\_or\_name*  
(Optional) Specifies the new group for the user.

*user\_id\_or\_name*  
(Required) Specifies the user whose attributes are to be changed.

## Description

Use the **chuser** command to modify the attributes of an existing user.

You must have the Security Administrator role to create, delete, or change a user.

Only use the **usergrp** parameter for local users. If you change a user from local to remote, the user's association with any group is removed.

If you change a user from remote to local, a user group must be specified. If you change a user from local to remote, the user must have both a password and an SSH key.

If you use the **keyfile** parameter, the SSH key file should be placed in the /tmp directory before running this command. When you run the command, the SSH key is copied into cluster state and activated for the user, and the input file is deleted.

### An invocation example

```
chuser -remote no -usergrp Monitor -nokey jane
```

### The resulting output

No feedback

---

## chusergrp

The **chusergrp** command changes the attributes of an existing user group.

## Syntax

```
▶▶ chusergrp -- [-role -- role_name] [-remote yes|no] -- groupid_or_name ▶▶
```

## Parameters

**-role** *role\_name*  
(Optional) Specifies the role to be associated with users that belong to this group. One of the following roles must be selected: Monitor, CopyOperator, Service, Administrator, or SecurityAdmin.

**-remote** **yes** | **no**  
(Optional) Specifies whether this user group should be used to set the role of remote users. Either the yes or no option must be set.

*groupid\_or\_name*  
(Required) Specifies the user group whose attributes are to be changed.

## Description

Use the **chusergrp** command to modify the attributes of an existing user group.

You must have the Security Administrator role to create, delete, or change a user.

The roles of the default groups cannot be changed.

### An invocation example

```
chusergrp -role Administrator admin
```

### The resulting output

No feedback

---

## mkuser

The **mkuser** command creates either a local or a remote user to access a SAN Volume Controller cluster.

### Syntax

```
mkuser -name user_name [-remote | -usergrp group_name_or_id] [-password cleartext_password] [-keyfile sshkey_filename]
```

### Parameters

#### **-name** *user\_name*

(Required) Specifies the unique user name. The user name cannot start or end with a blank. The user name must consist of a string of 1 - 256 ASCII characters, with the exception of the following characters: %:"\*'

#### **-remote** | **-usergrp** *group\_name\_or\_id*

(Required) Specifies whether the user authenticates to the cluster using a remote authentication service or cluster authentication methods. The **usergrp** parameter specifies the name or ID of the user group with which the local user is to be associated. Either the **remote** parameter or the **usergrp** parameter must be set.

#### **-password** *cleartext\_password*

(Optional) Specifies the password to be associated with the user. The password cannot start or end with a blank. It must consist of a string of 6 - 64 printable ASCII characters. You can optionally specify the password with the **password** parameter. If you do not specify the password, the system prompts you for it before running the command and does not display the password that you type.

#### **-keyfile** *sshkey\_filename*

(Optional) Specifies the name of the file that contains the Secure Shell (SSH) public key.

### Description

The **mkuser** command creates a new local or remote user to access a cluster. The command returns the ID of the created user.

You must have the Security Administrator role to create, delete, or change a user.

If you create a local user, you must specify the existing user group that the user belongs to. All local users must have a group. The user group defines roles that provide the user with access to specific operations on the cluster. You must also specify either the **keyfile** or **password** parameter, or both.

If you create a remote user, you must specify both the **keyfile** and **password** parameters. Remote users have their groups defined by the remote authentication service.



If you use the **keyfile** parameter, the SSH key file should be placed in the /tmp directory before running this command. When you run the command, the SSH key is copied into cluster state and activated for the user, and the input file is deleted.

### An invocation example

```
mkuser -name jane -usergrp Service -password secret
```

### The resulting output

```
User, id [1], successfully created
```

---

## mkusergrp

The **mkusergrp** command creates a new user group.

### Syntax

```
▶▶ mkusergrp — — -name — group_name — -role — role_name —————▶▶
└──────────┘
-remote
```

### Parameters

#### **-name** *group\_name*

(Required) Specifies the unique user group name. The group name cannot start or end with a blank. The group name must consist of a string of 1 - 64 ASCII characters, with the exception of the following characters: %:";\*' .

#### **-role** *role\_name*

(Required) Specifies the role to be associated with all users that belong to this user group. One of the following roles must be selected: Monitor, CopyOperator, Service, Administrator, or SecurityAdmin.

#### **-remote**

(Optional) Specifies that this user group should be used to set the role of remote users. This is disabled by default.

### Description

The **mkusergrp** command creates a new user group to organize users of the SAN Volume Controller cluster by role. Use the **lsusergrp** command to view a list of user groups that have been created on the cluster.

You must have the security administrator role (SecurityAdmin role name) to create, delete, or change a user group.

Each user group has one role that determines the role of users that belong to that group. Use the **role** parameter to specify one of the following roles for the user group:

#### **Monitor**

Users can issue the following commands: finderr, dumperrlog, dumpinternallog, chcurrentuser, ping, svcconfig backup, and all of the information commands.

#### **CopyOperator**

Users can issue the following commands: prestartfcconsistgrp, startfcconsistgrp, stopfcconsistgrp, chfcconsistgrp, prestartfcmap, startfcmap, stopfcmap, chfcmap, startcrconsistgrp, stopcrconsistgrp, switchcrconsistgrp, chrconsistgrp, startcrrelationship, stopcrrelationship, switchcrrelationship, chrrelationship, and chpartnership. In addition, users can issue all of the commands allowed by the Monitor role.

## Service

Users can issue the following commands: `applysoftware`, `setlocale`, `addnode`, `rmnode`, `cherrstate`, `writesernum`, `detectmdisk`, `includemdisk`, `clearerrlog`, `cleardumps`, `settimezone`, `stopcluster`, `startstats`, `stopstats`, and `settime`. In addition, users can issue all of the commands allowed by the Monitor role.

## Administrator

Users can issue all commands except: `chauthservice`, `mkuser`, `rmuser`, `chuser`, `mkusergrp`, `rmusergrp`, `chusergrp`, and `setpwdreset`

## SecurityAdmin

Users can issue all commands.

The command returns the ID of the created user group.

## An invocation example

```
mkusergrp -name support -role Service
```

## The resulting output

```
User Group, id [5], successfully created
```

---

## rmuser

The **rmuser** command deletes a user.

## Syntax

```
▶▶ rmuser — — user_id_or_name —————▶▶
```

## Parameters

*user\_id\_or\_name*

(Required) Specifies the user to be removed.

## Description

Use the **rmuser** command to delete a user.

You must have the Security Administrator role to create, delete, or change a user.

## An invocation example

```
rmuser jane
```

## The resulting output

```
No feedback
```

---

## rmusergrp

The **rmusergrp** command deletes a user group.

## Syntax

```
▶▶ rmusergrp — — group_id_or_name —————▶▶
 └─ force ─┘
```

## Parameters

### **-force**

(Optional) Specifies that the user group should be deleted even if there are users in the group.

### *group\_id\_or\_name*

(Required) Specifies the ID or name of the user group to be removed.

## Description

Use the **rmusergrp** command to delete a user group.

You must have the Security Administrator role to create, delete, or change a user group.

User groups with users cannot normally be deleted. If you use the **force** parameter, the group is deleted and all of the users in that group are assigned to the Monitor group. Default user groups cannot be deleted, even if the **force** parameter is set.

### **An invocation example**

```
rmusergrp support
```

### **The resulting output**

No feedback



---

## Chapter 29. Virtual disk commands

The following commands enable you to work with virtual disk options with the SAN Volume Controller.

---

### addvdiskcopy

The **addvdiskcopy** command adds a copy to an existing volume, which changes a nonmirrored volume into a mirrored volume.

**Note:** The first syntax diagram depicts the addition of a sequential or striped mode volume. The second syntax diagram depicts the addition of an image mode volume.

#### Syntax



#### Parameters

**-mdiskgrp** *mdisk\_group\_id\_list* | *mdisk\_group\_name\_list*

(Required) Specifies the managed disk groups to use to create copies for the virtual disk. You must specify a group for each copy that is being added.

**-vtype** *seq* | *striped* | *image*

(Optional) Specifies the virtualization type for the copy: sequential, striped, or image. The type can be different than the virtualization types for other copies on the volume. The default virtualization type is **striped**.

**-mdisk** *mdisk\_id\_list* | *mdisk\_name\_list*

(Optional) Specifies one or more managed disks (MDisks). For sequential and image mode copies, you must specify a single MDisk that has sufficient free extents. For image mode copies, the MDisk must be in unmanaged mode. For sequential mode copies the MDisk must be in the managed mode.

**-syncrate** *rate*

(Optional) Specifies the copy synchronization rate. A value of zero (0) prevents synchronization. The default value is 50. For the supported **-syncrate** values and their corresponding rates, see Table 55 on page 400.

**-createsync**

(Optional) Suppresses the synchronization of the new volume copy with the primary copy. Using this parameter can cause data corruption if the primary copy fails and leaves an unsynchronized secondary copy to provide data. Using this parameter can cause loss of read stability in unwritten areas if the primary copy fails, data is read from the primary copy, and then different data is read from the secondary copy. To avoid data loss or read stability loss, use this parameter only for a primary copy that has been formatted and not written to, and with the **-fmtdisk** parameter.

**-fmtdisk**

(Optional) Formats a sequential or striped mode copy. You must also specify the **-createsync** parameter, which labels the formatted copy as identical to the primary copy. The **-fmtdisk** parameter causes the volume to go offline until new volume copy formatting completes. To query the formatting progress, use the **lsvdiskprogress** command.

**-rsize** *disk\_size* | *disk\_size\_percentage* | **auto**

(Optional) Makes the copy space-efficient and specifies the real size of the copy. Specify the *disk\_size* | *disk\_size\_percentage* value using an integer, or an integer immediately followed by the percent character (%). The default units for *disk\_size* are megabytes (MB); to specify different units, use the **-unit** parameter. The **auto** option creates a volume copy that uses the entire size of the MDisk; if you specify the **-rsize auto** option, you must also specify the **-vtype image** option.

**-warning** *disk\_size* | *disk\_size\_percentage*%

(Optional) Requires that the **-rsize** parameter also be specified. Generates a warning when the used disk capacity on the space-efficient copy first exceeds the specified threshold. You can specify a *disk\_size* integer, which defaults to megabytes (MB) unless the **-unit** parameter is specified; or you can specify a *disk\_size*%, which is a percentage of the virtual disk size. If **-autoexpand** is enabled, the default value for **-warning** is 80% of the virtual disk capacity. If **-autoexpand** is not enabled, the default value for warning is 80% of the real capacity. To disable warnings, specify 0.

**-autoexpand**

(Optional) Requires that the **-rsize** parameter also be specified. Specifies that space-efficient copies automatically expand their real capacities by allocating new extents from their managed disk group. If the **-autoexpand** parameter is specified, the **-rsize** parameter specifies a capacity that is reserved by the copy. This protects the copy from going offline when its managed disk group runs out of space by allowing it to consume this reserved space first.

**-grainsize** **32** | **64** | **128** | **256**

(Optional) Requires that the **-rsize** parameter also be specified. Sets the grain size (KB) for a space-efficient volume copy. The default is 32 KB.

**-unit** **b** | **kb** | **mb** | **gb** | **tb** | **pb**

(Optional) Specifies the data units for the **-rsize** and **-warning** parameters.

**-import**

(Optional) Imports an image mode disk that contains a space-efficient volume into the clustered system. Requires that the **-rsize** and **-vtype image** parameters also be specified.

*vdisk\_name* | *vdisk\_id*

(Required) Specifies the virtual disk to add the volume copy to, either by ID or by name.

**-tier**

(Optional) Specifies the MDisk tier when an image mode copy is added.

**-easytier**

(Optional) Determines if the IBM System Storage Easy Tier function is allowed to move extents for this volume. If a volume copy is striped and not being migrated the following table applies:

Table 54. Storage pool Easy Tier settings

| Storage pool Easy Tier setting | Number of tiers in the storage pool | Volume copy Easy Tier setting | Volume copy Easy Tier status |
|--------------------------------|-------------------------------------|-------------------------------|------------------------------|
| Off                            | One                                 | Off                           | inactive (see note 2)        |
| Off                            | One                                 | On                            | inactive (see note 2)        |
| Off                            | Two                                 | Off                           | inactive (see note 2)        |
| Off                            | Two                                 | On                            | inactive (see note 2)        |
| Auto (see note 5)              | One                                 | Off                           | inactive (see note 2)        |
| Auto (see note 5)              | One                                 | On                            | inactive (see note 2)        |
| Auto (see note 5)              | Two                                 | Off                           | measured (see note 3)        |
| Auto (see note 5)              | Two                                 | On                            | active (see note 1)          |
| On (see note 5)                | One                                 | Off                           | measured (see note 3)        |
| On (see note 5)                | One                                 | On                            | measured (see note 3)        |
| On (see note 5)                | Two                                 | Off                           | measured (see note 3)        |
| On (see note 5)                | Two                                 | On                            | active (see note 1)          |

**Note:**

1. If the volume copy is in image or sequential mode or is being migrated then the volume copy Easy Tier status will be *measured* instead of *active*.
2. When the volume copy status is *inactive*, no Easy Tier functions are enabled for that volume copy.
3. When the volume copy status is *measured*, the Easy Tier function collects usage statistics for the volume but automatic data placement is not active.
4. When the volume copy status is *active*, the Easy Tier function operates in automatic data placement mode for that volume.
5. The default Easy Tier setting for a storage pool is *auto*, and the default Easy Tier setting for a volume copy is *on*. This means that Easy Tier functions will be disabled for storage pools with a single tier, and that automatic data placement mode will be enabled for all striped volume copies in a storage pool with two tiers.

## Description

The **addvdiskcopy** command adds a copy to an existing volume, which changes a nonmirrored volume into a mirrored volume. Use the **-mdiskgrp** parameter to specify the managed disk group that will provide storage for the copy; the **lsmdiskgrp** command lists the available managed disk groups and the amount of available storage in each group.

The virtualization types are defined as follows:

**sequential (seq)**

This policy requires the **-mdisk** parameter with a single managed disk as its argument. This MDisk must be in the managed mode.

It creates the virtual disk using extents from the given managed disk (assuming there are enough free extents on the managed disk).

**striped**

This is the default policy. If the **-vtype** parameter is not specified, this policy is used in its default

form. That is, all managed disks in the managed disk group are used to create the virtual disk. The striping is at an extent level; one extent from each managed disk in the group is used. For example, a managed disk group with 10 managed disks uses one extent from each managed disk, then it uses the 11th extent from the first managed disk, and so on.

If the **-mdisk** parameter is also specified, you can supply a list of managed disks to use as the stripe set. This can be two or more managed disks from the same managed disk group. The same circular algorithm is used across the striped set. However, a single managed disk can be specified more than once in the list. For example, if you enter **-m 0:1:2:1**, the extents are from the following **managed** disks: 0, 1, 2, 1, 0, 1, 2, and so forth. All MDisks that are specified in the **-mdisk** parameter must be in **managed** mode.

**image** This policy allows image mode virtual disks to be created when a managed disk already has data on it, perhaps from a previrtualized subsystem. When an image mode virtual disk is created, it directly corresponds to the (previously unmanaged) managed disk that it was created from; therefore, virtual disk logical block address (LBA) *x* equals managed disk LBA *x*. You can use this command to bring a nonvirtualized disk under the control of the clustered system. After it is under the control of the clustered system, you can migrate the virtual disk from the single managed disk. When it is migrated, the virtual disk is no longer an image mode virtual disk.

You can add image mode volumes to an already populated storage pool with other types of volumes, such as a striped or sequential.

**Note:** An image mode copy must be at least as large as the volume that it is being added to, but any capacity beyond the size of the volume is not accessible.

The command returns the ID of the newly created volume copy.

Table 55 provides the relationship of the *rate* value to the data copied per second.

*Table 55. Relationship between the rate value and the data copied per second*

| User-specified <i>rate</i> attribute value | Data copied/sec |
|--------------------------------------------|-----------------|
| 1 - 10                                     | 128 KB          |
| 11 - 20                                    | 256 KB          |
| 21 - 30                                    | 512 KB          |
| 31 - 40                                    | 1 MB            |
| 41 - 50                                    | 2 MB            |
| 51 - 60                                    | 4 MB            |
| 61 - 70                                    | 8 MB            |
| 71 - 80                                    | 16 MB           |
| 81 - 90                                    | 32 MB           |
| 91 - 100                                   | 64 MB           |

### An invocation example

```
addvdiskcopy -mdiskgrp 0 -easytier off vdisk8
```

### The resulting output

```
Vdisk [8] copy [1] successfully created
```

### An invocation example

```
addvdiskcopy -mdiskgrp 0 -vtype image -mdisk 13 -tier generic_ssd -easytier off vdisk9
```

### The resulting output



Vdisk [9] copy [1] successfully created

## chvdisk

The **chvdisk** command modifies the properties of a volume, such as the disk name, I/O group, I/O governing rate, or unit number.

### Syntax

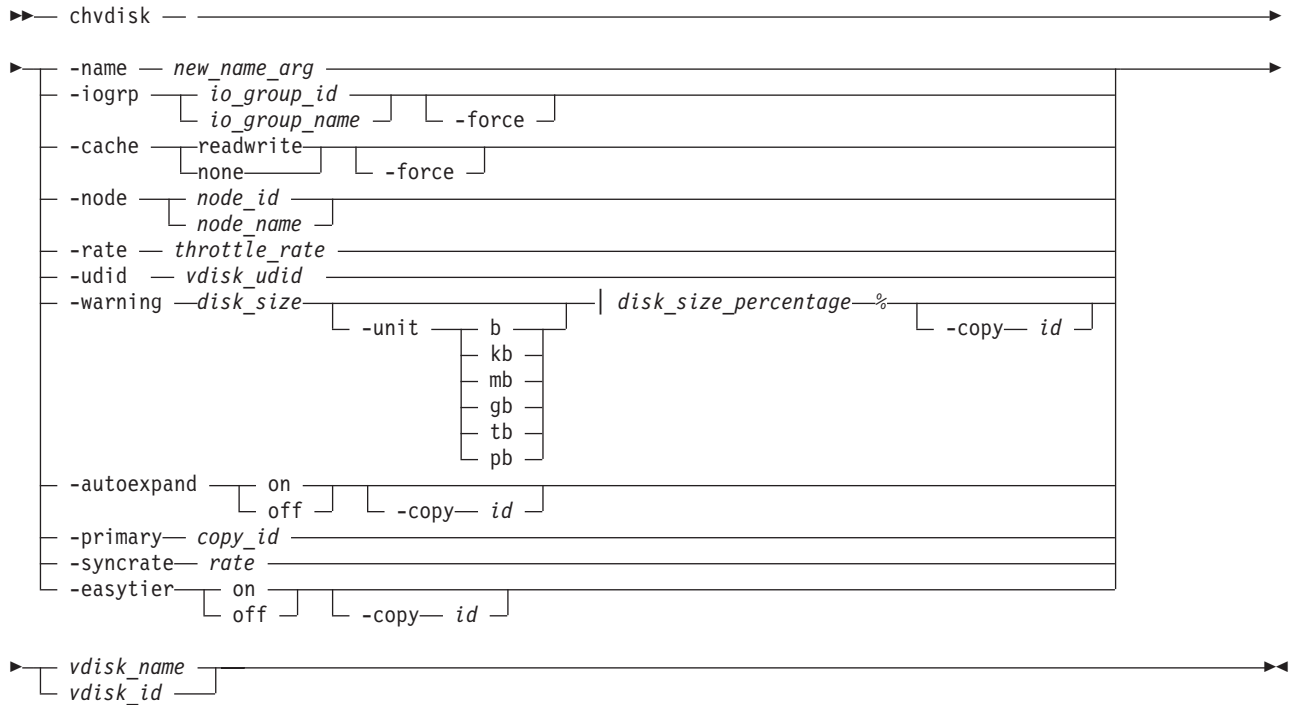

### Parameters

#### **-name** *new\_name\_arg*

(Optional) Specifies a new name to assign to the virtual disk. You cannot use this parameter with the **-iogrp**, **-rate**, **-node**, or **-udid** parameters. This parameter is required if you do not use the **-iogrp**, **-rate**, or **-udid** parameter.

#### **-iogrp** *io\_group\_id* | *io\_group\_name*

(Optional) Specifies a new I/O group to move the virtual disk to, by I/O group ID or I/O group name. You can use the **-node** parameter with the **-iogrp** parameter to specify a preferred node for the specified volume.

#### Notes:

1. If the volume has a mapping to any hosts, it is not possible to move the volume to an I/O group, unless all of those hosts are associated with the new I/O group.
2. This parameter can fail if there is not enough space to allocate bitmaps for a mirrored volume in the target I/O group.
3. This parameter can fail if any copy is not synchronized. The **-force** parameter can be used to force the move, but this resynchronizes the volume.

#### **-cache** *readwrite* | *none*

(Optional) Specifies the caching options for the volume. Valid entries are **readwrite**, to enable the cache for the volume, or **none**, to disable the cache mode for the volume.

### **-force**

(Optional) The **force** parameter can only be used for changing the I/O group of a volume or the caching mode. Use the **force** parameter with the **iogrp** parameter to force the volume to be removed from an I/O group. Use the **force** parameter with the **cache** parameter to specify that you want the system to change the cache mode of the volume even if the I/O group is offline. This option overrides the cache flush mechanism.

#### **Attention:**

1. If the **force** parameter is used for changing the caching mode or I/O group of a volume, the contents of the cache are discarded and the volume might be corrupted by the loss of the cached data. This could occur if the clustered system is able to destage all write data from the cache or not. The **force** parameter should be used with caution.
2. If the **force** parameter is used to move a volume that has out-of-sync copies, a full resynchronization is required.

### **-node** *node\_id* | *node\_name*

(Optional) Specifies a preferred node for the specified volume. This parameter can only be specified when using the **iogrp** parameter to move the volume to another I/O group. This parameter is mutually exclusive to all other parameters except for **iogrp** and **-force**.

### **-rate** *throttle\_rate* [**-unitmb**]

(Optional) Specifies the I/O governing rate for the volume, which caps the amount of I/O that is accepted. The default *throttle\_rate* units are I/Os. To change the *throttle\_rate* units to megabytes per second (MBps), specify the **-unitmb** parameter. The governing rate for a virtual disk can be specified by I/Os or by MBps, but not both. However, you can set the rate to I/Os for some virtual disks and to MBps for others.

You cannot use this parameter with the **-name**, **-iogrp**, **-node**, or **-udid** parameters.

### **-udid** *vdisk\_udid*

(Optional) Specifies the unit number (**udid**) for the disk. The *vdisk\_udid* is an identifier that is required to support OpenVMS hosts; no other systems use this parameter. Valid options are a decimal number from 0 to 32 767 or a hexadecimal number from 0 to 0x7FFF. A hexadecimal number must be preceded by **0x** (for example, **0x1234**). If you do not use the **-udid** parameter, the default **udid** is **0**.

You cannot use this parameter with the **-name**, **-iogrp**, **-node**, or **-rate** parameters.

### **-warning** *disk\_size* | *disk\_size\_percentage*%

(Optional) Generates a warning when the used disk capacity on the space-efficient copy first exceeds the specified threshold. You can specify a *disk\_size* integer, which defaults to MBs unless the **-unit** parameter is specified; or you can specify a *disk\_size*%, which is a percentage of the virtual disk size. To disable warnings, specify **0** or **0%**.

### **-unit** **b** | **kb** | **mb** | **gb** | **tb** | **pb**

(Optional) Specifies the data units to use for the **-warning** *disk\_size* parameter.

### **-autoexpand** **on** | **off**

(Optional) Specifies whether space-efficient volume copies automatically expand their real capacities by allocating new extents from their managed disk group. To use this parameter, the volume must be space-efficient.

### **-copy** *id*

(Optional) Specifies the copy to apply the changes to. You must specify this parameter with the **-autoexpand** or **-warning** parameter. The **-copy** parameter is required if the specified volume is mirrored and only one volume copy is space-efficient. If both copies are space-efficient and the **-copy** parameter is not specified, the specified **-autoexpand** or **-warning** parameter is set on both copies.

### **-primary** *copy\_id*

(Optional) Specifies the primary copy. Changing the primary copy only takes effect when the new

primary copy is online and synchronized. If the new primary is online and synchronized when the command is issued, the change takes effect immediately.

**-syncrate** *rate*

(Optional) Specifies the copy synchronization rate, as a percentage of the peak synchronization rate. A value of zero (0) prevents synchronization.

**-easytier** *on | off*

(Optional) Enables or disables the IBM System Storage Easy Tier function.

*vdisk\_name | vdisk\_id*

(Required) Specifies the volume to modify, either by ID or by name.

## Description

The **chvdisk** command modifies a single property of a volume. To change the volume name and modify the I/O group, for example, you must issue the command twice.

**Note:** If the volume is offline, use one of the **recovervdisk** commands to recover the volume volume and bring it back online.

You can specify a new name or label. You can use the new name subsequently to refer to the virtual disk. To specify a preferred node for the volume, use the **-node** *node\_id | node\_name* parameter.

You can change the I/O group with which this virtual disk is associated. However, to change the I/O group, you must first flush the cache within the nodes in the current I/O group to ensure that all data is written to disk. Ensure that you suspend I/O operations at the host level before you perform this operation.

**Attention:**

1. Do not move a volume to an offline I/O group under any circumstance. To avoid any data loss, you must ensure that the I/O group is online before you move the (volumes).
2. Do not move an offline volume to the recovery I/O group. Beginning with SAN Volume Controller version 4.3.1, use of the recovery I/O group is not required. Instead, use one of the **recovervdisk** commands to recover the volume and bring it back online.

You can set a limit on the amount of I/O transactions that is accepted for this virtual disk. It is set in terms of I/Os per second or MBs per second. By default, no I/O governing rate is set when a virtual disk is created.

**Attention:** All capacities, including changes, must be in multiples of 512 bytes. An error occurs if you specify a capacity that is not a multiple of 512, which can only happen when byte units (**-b**) are used. The default capacity is in MB.

When the virtual disk is created, there is no throttling applied to it. Using the **-rate** parameter can change this. To change the virtual disk back to an unthrottled state, specify 0 (zero) with the **-rate** parameter.

You can migrate a volume to a new I/O group to manually balance the workload across the nodes in the clustered system. You might end up with a pair of nodes that are overworked and another pair that are underworked. Use the following procedure to migrate a single volume to a new I/O group. Repeat for other volumes as required.

**Attention:** This is a disruptive procedure. Access to the volume is lost while you follow this procedure.

Ensure that when you migrate a volume to a new I/O group, you quiesce all I/O operations for the volume. Determine the hosts that are using this volume. Stop and delete any FlashCopy mappings or

Metro or Global Mirror relationships that use this volume. To check if the volume is part of a relationship or mapping, issue the **lsvdisk** *vdiskname* | *id* command, where *vdiskname* | *id* is the name or ID of the volume.

Look for the **FC\_id** and **RC\_id** fields. If these are not blank, the volume is part of a mapping or relationship. See the FlashCopy commands or Metro Mirror and Global Mirror commands for details on how to stop or delete the mapping or relationship. Issue the following command to migrate the volume:

```
chvdisk -iogrp newiogrpname | id vdiskname | id
```

Follow the procedure to discover the new vpaths and to check that each vpath is presenting the correct number of paths. Refer to Multipath Subsystem Device Driver (SDD) documentation for details on how to dynamically reconfigure SDD for the given host operating system.

**Note:** The command fails if you attempt to change the primary copy of a mirrored volume while the **repairvdiskcopy -resync** command is running.

### An invocation example

```
chvdisk -rate 2040 -unitmb 6
```

### The resulting output

No feedback

## expandvdisksize

The **expandvdisksize** command expands the size of a VDisk by a given capacity.

### Syntax

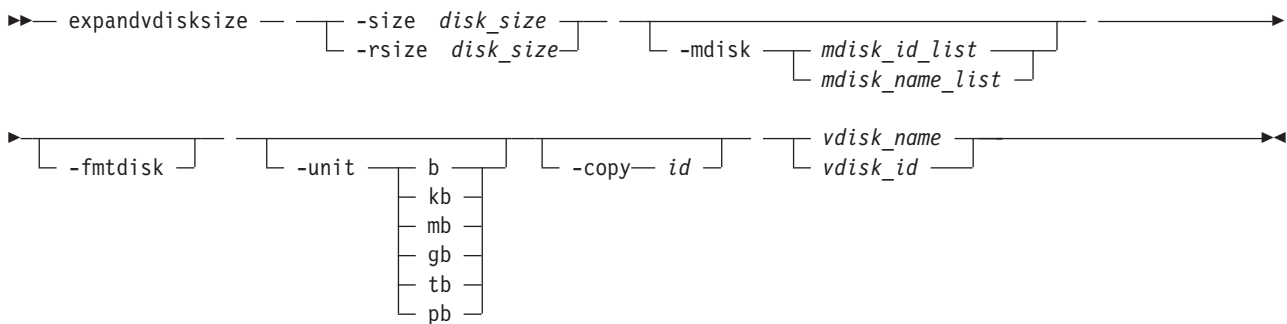

### Parameters

#### -size *disk\_size*

(Optional) Specifies the capacity by which the virtual disk is expanded. Disk size is used with the value of the unit. All capacities, including changes must be in multiples of 512 bytes. An error occurs if you specify a capacity that is not a multiple of 512, which can only occur when byte units (**-unit b**) are used. However, an entire extent is reserved even if it is only partially used. The default *disk\_size* unit is megabytes (MB). You cannot specify the **-size** parameter with the **-rsize** parameter. You must specify either **-size** or **-rsize**. If the VDisk is space-efficient, MDisks cannot be specified.

#### -rsize *disk\_size*

(Optional) Specifies the capacity by which to increase the real size of a space-efficient VDisk. Specify the *disk\_size* value using an integer. Specify the unit for a *disk\_size* integer using the **-unit** parameter;

the default unit is megabytes (MB). The **-rsize** value can be greater than, equal to, or less than the size of the VDisk. You cannot specify the **-rsize** parameter with the **-size** parameter. You must specify either **-size** or **-rsize**.

**-copy *id***

(Optional) Specifies the copy to change the real capacity for. You must also specify the **-rsize** parameter; you can only modify the real capacity of a VDisk copy. The **-copy** parameter is required if the specified VDisk is mirrored and only one copy is space-efficient. If the VDisk is mirrored, both copies are space-efficient and **-copy** is not specified, both copies are modified by the same amount.

**-mdisk *mdisk\_id\_list* | *mdisk\_name\_list***

(Optional) Specifies the list of one or more MDisks to be used as the stripe set. The extents that expand the VDisk come from the specified list of MDisks. All MDisks in the list must be part of the same MDisk group. The **-mdisk** parameter cannot be used if the specified VDisk is mirrored.

**-fmtdisk**

(Optional) Specifies that the VDisk be formatted before use. This parameter formats the new extents that have been added to the VDisk as a result of the **expandvdisksize** command. The **expandvdisksize** command completes asynchronously if you use this parameter.

**-unit *b* | *kb* | *mb* | *gb* | *tb* | *pb***

(Optional) Specifies the *disk\_size* unit for the **-size** or **-rsize** parameter. The default value is megabytes (MB).

***vdisk\_name* | *vdisk\_id***

(Required) Specifies the virtual disk to modify, either by ID or by name.

## Description

The **expandvdisksize** command can be used to expand the physical capacity that is allocated to a particular VDisk by the specified amount. The command can also be used to expand the virtual capacity of a space-efficient VDisk without altering the physical capacity that is assigned to the VDisk. To change the capacity of a non-space-efficient VDisk, or the virtual capacity of a space-efficient VDisk, use the **-size** parameter. To change the real capacity of a space-efficient VDisk, use the **-rsize** parameter.

The default capacity units are MB.

When a VDisk is expanded, the virtualization policy can change. Its mode becomes striped even if it was previously sequential. See the **mkvdisk** command for details of the virtualization policies.

To run the **expandvdisksize** command on a mirrored VDisk, all copies of the VDisk must be synchronized. The command formats all copies of a mirrored VDisk automatically.

### An invocation example

To increase the capacity of VDisk1 by 2048 bytes by using extents from two MDisks and to format the new part of the VDisk, enter:

```
expandvdisksize -size 2048 -unit b -mdisk mdisk0:mdisk1 -fmtdisk vdisk1
```

### The resulting output

No feedback

### An invocation example

To increase the capacity of VDisk1 by 100 MB using extents from two MDisks, and to format the new part of the VDisk, enter:

```
expandvdisksize -size 100 -unit mb -mdisk mdisk0:mdisk1 -fmtdisk vdisk1
```

## The resulting output

No feedback

## An invocation example

To increase the real capacity of space-efficient VDisk **vdisk2** by 100 MB without changing the virtual capacity, and to spread the extents across all MDisks in the MDisk group, enter:

```
expandvdisksize -rsize 100 -unit mb vdisk2
```

## The resulting output

No feedback

## An invocation example

To increase the real capacity of space-efficient VDisk copy id 1 of mirrored VDisk **vdisk3** by 100 MB, enter:

```
expandvdisksize -rsize 100 -unit mb -copy 1 vdisk3
```

## The resulting output

No feedback

---

## mkvdisk

The **mkvdisk** command creates sequential, striped, or image mode volume objects. When they are mapped to a host object, these objects are seen as disk drives with which the host can perform I/O operations.

**Note:** The first syntax diagram depicts the creation of a **striped** mode volume. The second syntax diagram depicts the creation of a **sequential** or **image** mode volume.

## Syntax

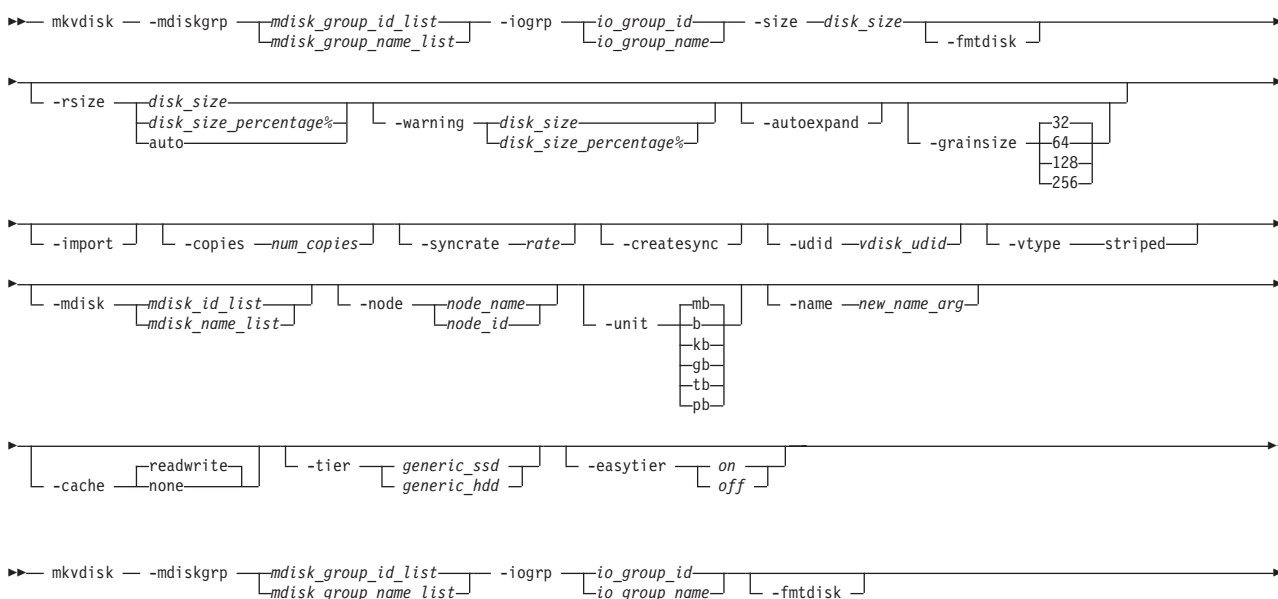

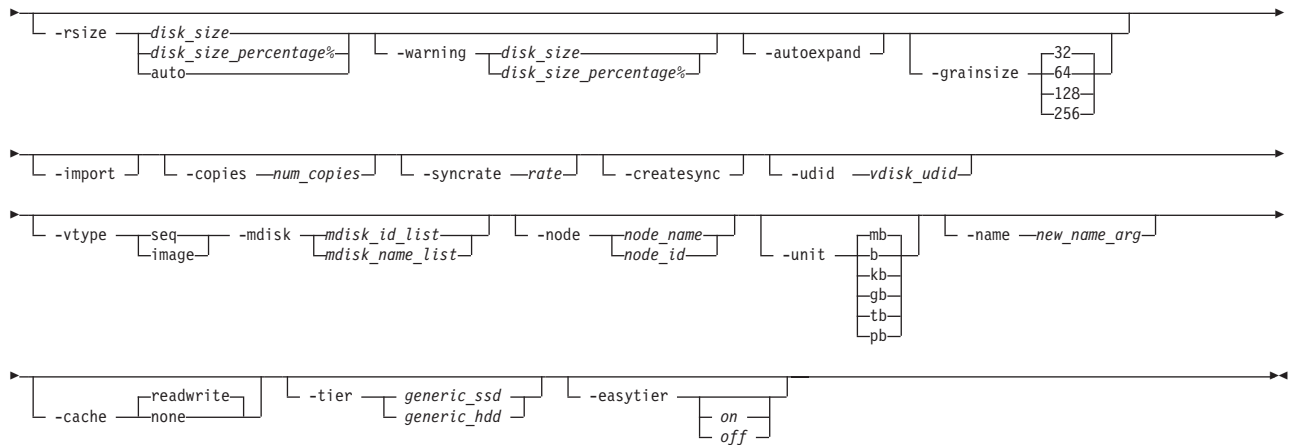

## Parameters

**-mdiskgrp** *mdisk\_group\_id\_list* | *mdisk\_group\_name\_list*

(Required) Specifies one or more managed disk groups (storage pools) to use when you are creating this volume. If you are creating multiple copies, you must specify one managed disk group per copy. The primary copy is allocated from the first managed disk group in the list.

**-iogrp** *io\_group\_id* | *io\_group\_name*

(Required) Specifies the I/O group (node pair) with which to associate this volume.

**-udid** *vdisk\_udid*

(Optional) Specifies the unit number (**udid**) for the disk. The **udid** is an identifier that is required to support OpenVMS hosts; no other systems use this parameter. Valid options are a decimal number 0 - 32 767, or a hexadecimal number 0 - 0x7FFF. A hexadecimal number must be preceded by **0x** (for example, **0x1234**).

**-size** *disk\_size*

(Required for sequential [**seq**] or **striped** volume creation) (Optional for **image** volume creation) Specifies the capacity of the volume, which is used with the value of the unit. All capacities, including changes, must be in multiples of 512 bytes. An error occurs if you specify a capacity that is not a multiple of 512, which can only happen when byte units (**-b**) are used. However, an entire extent is reserved even if it is only partially used. The default capacity is in MB. You can specify a capacity of 0. Specify the size in bytes in multiples of logical block address (LBA) sizes.

**Note:** If you do not specify the **-size** parameter when you create an image mode disk, the entire MDisk capacity is used.

**-rsize** *disk\_size* | *disk\_size\_percentage%* | **auto**

(Optional) Defines how much physical space is initially allocated to the space-efficient volume (thin-provisioned volume). This parameter makes the volume space-efficient; otherwise, the volume is fully allocated. Specify the *disk\_size* | *disk\_size\_percentage* value using an integer, or an integer immediately followed by the percent character (%). Specify the units for a *disk\_size* integer using the **-unit** parameter; the default is MB. The **-rsize** value can be greater than, equal to, or less than the size of the volume. The **auto** option creates a volume copy that uses the entire size of the MDisk; if you specify the **-rsize auto** option, you must also specify the **-vtype image** option.

**-warning** *disk\_size* | *disk\_size\_percentage%*

(Optional) Requires that the **-rsize** parameter also be specified. Specifies a threshold at which a warning error log is generated for volume copies. A warning is generated when the used disk capacity on the space-efficient copy first exceeds the specified threshold. You can specify a *disk\_size* integer, which defaults to MBs unless the **-unit** parameter is specified; or you can specify a *disk\_size%*,

which is a percentage of the volume size. If **-autoexpand** is enabled, the default value for **-warning** is 80% of the volume capacity. If **-autoexpand** is not enabled, the default value for warning is 80% of the real capacity. To disable warnings, specify **0**.

**-autoexpand**

(Optional) Specifies that space-efficient copies automatically expand their real capacities by allocating new extents from their managed disk group. Requires that the **-rsize** parameter also be specified. If the **-autoexpand** parameter is specified, the **-rsize** parameter specifies a capacity that is reserved by the copy. This protects the copy from going offline when its managed disk group runs out of space by having the managed disk group to consume this reserved space first.

The parameter has no immediate effect on **image** mode copies. However, if the image mode copy is subsequently migrated to managed mode, the copy is then automatically expanded.

**-grainsize 32 | 64 | 128 | 256**

(Optional) Sets the grain size (KB) for a space-efficient volume. This parameter also requires that the **-rsize** parameter be specified. The default is 32 KB. If you are using the space-efficient volume in a FlashCopy map, use the same grain size as the map grain size for best performance. If you are using the space-efficient volume directly with a host system, use a small grain size.

**-import**

(Optional) Imports a space-efficient volume from the MDisk. This parameter also requires that the **-rsize** parameter be specified.

**-copies num\_copies**

(Optional) Specifies the number of copies to create. The *num\_copies* value can be 1 or 2. Setting the value to 2 creates a mirrored volume. The default value is 1.

**-syncrate rate**

(Optional) Specifies the copy synchronization rate. A value of zero (0) prevents synchronization. The default value is 50. For the supported **-syncrate** values and their corresponding rates, see Table 57 on page 411.

**-createsync**

(Optional) Creates copies in sync. Use this parameter if you have already formatted the MDisks, or when read stability to unwritten areas of the volume is not required.

**-fmtdisk**

(Optional) Specifies that the volume be formatted before it can be used. The **-fmtdisk** parameter formats (sets to all zeros) the extents that make up this volume after it is created. If this parameter is used, the command completes asynchronously; you can query the status using the **lsvdiskprogress** command.

The **-fmtdisk** parameter is not required when creating space-efficient volumes. Space-efficient volumes return zeros for extents that have not been written to.

The **-fmtdisk** parameter synchronizes mirrored copies by default.

**Note:** You cannot specify this parameter with the **-vtype image** parameter.

**-vtype seq | striped | image**

(Optional) Specifies the virtualization type. When creating sequential or image mode volumes, you must also specify the **-mdisk** parameter. The default virtualization type is striped.

**-node node\_id | node\_name**

(Optional) Specifies the preferred node ID or the name for I/O operations to this volume. You can use the **-node** parameter to specify the preferred access node.

**Note:** This parameter is required for the subsystem device driver (SDD). The clustered system chooses a default if you do not supply this parameter.



**-unit** *b | kb | mb | gb | tb | pb*

(Optional) Specifies the data units to use in conjunction with the capacity that is specified by the **-size** and **-rsize** parameters.

**-mdisk** *mdisk\_id\_list | mdisk\_name\_list*

(Optional) Specifies one or more managed disks. For sequential and image mode volumes, the number of MDisks must match the number of copies. For sequential mode volumes, each MDisk must belong to the specified storage pool. For striped volumes, you cannot specify the **-mdisk** parameter if the **-copies** value is greater than 1. When creating a single copy striped volume, you can specify a list of MDisks to stripe across.

**-name** *new\_name\_arg*

(Optional) Specifies a name to assign to the new volume.

**-cache** *readwrite | none*

(Optional) Specifies the caching options for the volume. Valid entries are **readwrite** or **none**. The default is **readwrite**. If you do not specify the **-cache** parameter, the default value (**readwrite**) is used.

**-tier**

(Optional) Specifies the MDisk tier when an image mode copy is added.

**Note:** This will apply to both copies if you are creating mirrored volumes with two image mode copies using this command.

**-easytier**

(Optional) Determines if the IBM System Storage Easy Tier function is allowed to move extents for this volume. If a volume copy is striped and not being migrated the following table applies:

Table 56. Storage pool Easy Tier settings

| Storage pool Easy Tier setting | Number of tiers in the storage pool | Volume copy Easy Tier setting | Volume copy Easy Tier status      |
|--------------------------------|-------------------------------------|-------------------------------|-----------------------------------|
| Off                            | One                                 | Off                           | inactive (see note 2 on page 410) |
| Off                            | One                                 | On                            | inactive (see note 2 on page 410) |
| Off                            | Two                                 | Off                           | inactive (see note 2 on page 410) |
| Off                            | Two                                 | On                            | inactive (see note 2 on page 410) |
| Auto (see note 5 on page 410)  | One                                 | Off                           | inactive (see note 2 on page 410) |
| Auto (see note 5 on page 410)  | One                                 | On                            | inactive (see note 2 on page 410) |
| Auto (see note 5 on page 410)  | Two                                 | Off                           | measured (see note 3 on page 410) |
| Auto (see note 5 on page 410)  | Two                                 | On                            | active (see note 1 on page 410)   |
| On (see note 5 on page 410)    | One                                 | Off                           | measured (see note 3 on page 410) |
| On (see note 5 on page 410)    | One                                 | On                            | measured (see note 3 on page 410) |
| On (see note 5 on page 410)    | Two                                 | Off                           | measured (see note 3 on page 410) |
| On (see note 5 on page 410)    | Two                                 | On                            | active (see note 1 on page 410)   |

Table 56. Storage pool Easy Tier settings (continued)

| Storage pool Easy Tier setting                                                                                                                                                                                                                                                                                                                            | Number of tiers in the storage pool | Volume copy Easy Tier setting | Volume copy Easy Tier status |
|-----------------------------------------------------------------------------------------------------------------------------------------------------------------------------------------------------------------------------------------------------------------------------------------------------------------------------------------------------------|-------------------------------------|-------------------------------|------------------------------|
| <b>Note:</b>                                                                                                                                                                                                                                                                                                                                              |                                     |                               |                              |
| 1. If the volume copy is in image or sequential mode or is being migrated then the volume copy Easy Tier status will be <i>measured</i> instead of <i>active</i> .                                                                                                                                                                                        |                                     |                               |                              |
| 2. When the volume copy status is <i>inactive</i> , no Easy Tier functions are enabled for that volume copy.                                                                                                                                                                                                                                              |                                     |                               |                              |
| 3. When the volume copy status is <i>measured</i> , the Easy Tier function collects usage statistics for the volume but automatic data placement is not active.                                                                                                                                                                                           |                                     |                               |                              |
| 4. When the volume copy status is <i>active</i> , the Easy Tier function operates in automatic data placement mode for that volume.                                                                                                                                                                                                                       |                                     |                               |                              |
| 5. The default Easy Tier setting for a storage pool is <i>auto</i> , and the default Easy Tier setting for a volume copy is <i>on</i> . This means that Easy Tier functions will be disabled for storage pools with a single tier, and that automatic data placement mode will be enabled for all striped volume copies in a storage pool with two tiers. |                                     |                               |                              |

## Description

This command creates a new volume object. You can use the command to create a variety of types of volume objects, making it one of the most complex commands.

You must decide which managed disk group or groups provide the storage for the volume. Use the **lsmdiskgrp** command to list the available managed disk groups and the amount of free storage in each group. If you are creating a volume with more than one copy, each storage pool that you specify must have enough space for the size of the volume.

**Important:** The extent size for the storage pool can limit volume size. Consider the maximum volume size you want to use when creating storage pools. Refer to the information on creating storage pools for a comparison of the maximum volume capacity for each extent size. The maximum is different for space-efficient volumes (thin-provisioned volumes).

Choose an I/O group for the volume. This determines which nodes in the clustered system process the I/O requests from the host systems. If you have more than one I/O group, ensure that you distribute the volumes between the I/O groups so that the I/O workload is shared evenly between all nodes. Use the **lsiogrp** command to show the I/O groups and the number of volumes that are assigned to each I/O group.

**Note:** It is normal for clustered systems with more than one I/O group to have storage pools that have volumes in different I/O groups. FlashCopy processing can make copies of volumes whether the source and target volumes are in the same I/O group. If, however, you plan to use intra-clustered system Metro or Global Mirror operations, ensure that both the master and auxiliary volume are in the same I/O group.

Specify the virtualization type using the **-vtype** parameter; the supported types are **sequential (seq)**, **striped**, and **image**.

### sequential (seq)

This virtualization type creates the volume using sequential extents from the specified MDisk (or MDisks, if creating multiple copies). The command fails if there are not enough sequential extents on the specified MDisk.

### striped

This is the default virtualization type. If the **-vtype** parameter is not specified, **striped** is the default; all managed disks in the managed disk group are used to create the volume. The striping is at an extent level; one extent from each managed disk in the group is used. For example, a

managed disk group with 10 managed disks uses one extent from each managed disk, then it uses the 11th extent from the first managed disk, and so on.

If the **-mdisk** parameter is also specified, you can supply a list of managed disks to use as the stripe set. This can be two or more managed disks from the same managed disk group. The same circular algorithm is used across the striped set. However, a single managed disk can be specified more than once in the list. For example, if you enter **-mdisk 0:1:2:1**, the extents are from the following managed disks: 0, 1, 2, 1, 0, 1, 2, and so forth. All MDisks that are specified in the **-mdisk** parameter must be in the managed mode.

A capacity of 0 is allowed.

**image** This virtualization type allows image mode volumes to be created when a managed disk already has data on it, perhaps from a previrtualized subsystem. When an image mode volume is created, it directly corresponds to the (previously unmanaged) managed disk that it was created from. Therefore, with the exception of space-efficient image mode volumes, volume logical block address (LBA)  $x$  equals managed disk LBA  $x$ . You can use this command to bring a nonvirtualized disk under the control of the clustered system. After it is under the control of the clustered system, you can migrate the volume from the single managed disk. When it is migrated, the volume is no longer an image mode volume.

You can add image mode volumes to an already populated storage pool with other types of volumes, such as a striped or sequential.

**Note:** An image mode volume must be 512 bytes or greater. At least one extent is allocated to an image mode volume.

You must use the **-mdisk** parameter to specify an MDisk that has a mode of unmanaged. The **-fmtdisk** parameter cannot be used to create an image mode volume.

**Note:** If you create a mirrored volume from two image mode MDisks without specifying a **-capacity** value, the capacity of the resulting volume is the smaller of the two MDisks, and the remaining space on the larger MDisk is not accessible.

The command returns the IDs of the newly created volume.

**Attention:**

1. Do not create a volume in an offline I/O group. You must ensure that the I/O group is online before you create a volume to avoid any data loss. This applies in particular to recreating volumes that are assigned the same object ID.
2. To create an image mode disk, you must already have a quorum disk in the clustered system because an image mode disk cannot be used to hold quorum data. Refer to information on quorum disk creation for more details.
3. The command fails if either limit of 2048 volumes per I/O Group or 8192 volume copies per clustered system is reached.

Table 57 provides the relationship of the *rate* value to the data copied per second.

*Table 57. Relationship between the rate value and the data copied per second*

| User-specified <i>rate</i> attribute value | Data copied/sec |
|--------------------------------------------|-----------------|
| 1 - 10                                     | 128 KB          |
| 11 - 20                                    | 256 KB          |
| 21 - 30                                    | 512 KB          |
| 31 - 40                                    | 1 MB            |
| 41 - 50                                    | 2 MB            |

Table 57. Relationship between the rate value and the data copied per second (continued)

| User-specified <i>rate</i> attribute value | Data copied/sec |
|--------------------------------------------|-----------------|
| 51 - 60                                    | 4 MB            |
| 61 - 70                                    | 8 MB            |
| 71 - 80                                    | 16 MB           |
| 81 - 90                                    | 32 MB           |
| 91 - 100                                   | 64 MB           |

### An invocation example

```
mkvdisk -mdiskgrp Group0 -size 0
-iogrp 0 -vtype striped -mdisk mdisk1 -node 1
```

### The resulting output

Virtual Disk, id [1], successfully created

### An invocation example for creating an image mode volume

```
mkvdisk -mdiskgrp Group0
-iogrp 0 -vtype image -mdisk mdisk2 -node 1
```

### The resulting output

Virtual Disk, id [2], successfully created

### An invocation example for creating a new volume

```
mkvdisk -mdiskgrp Group0 -size 0 -unit kb
-iogrp 0 -vtype striped -mdisk mdisk1 -node 1 -udid 1234 -easytier off
```

### The resulting output

Virtual Disk id [2], successfully created

### An invocation example for creating a space-efficient volume

```
mkvdisk -mdiskgrp Group0 -iogrp 0 -vtype striped
-size 10 -unit gb -rsize 20% -autoexpand -grainsize 32
```

### The resulting output

Virtual Disk id [1], successfully created

### An invocation example for creating a mirrored image-mode volume

```
mkvdisk -mdiskgrp Group0:Group0 -mdisk mdisk2:mdisk3
-iogrp 0 -vtype image -copies 2
```

### The resulting output

Virtual Disk id [1], successfully created

### An invocation example for creating a mirrored volume

```
mkvdisk -iogrp 0 -mdiskgrp 0:1 -size 500 -copies 2
```

### The resulting output

Virtual Disk id [5], successfully created

---

## mkvdiskhostmap

The **mkvdiskhostmap** command creates a new mapping between a virtual disk and a host, which makes the virtual disk accessible for I/O operations to the specified host.

### Syntax

```
mkvdiskhostmap [-force] -host host_id | host_name [-scsi scsi_num_arg] vdisk_name | vdisk_id
```

### Parameters

#### -force

(Optional) Allows multiple VDisk-to-host assignments, which are not normally allowed.

#### -host *host\_id* | *host\_name*

(Required) Specifies the host to map the virtual disk to, either by ID or by name.

#### -scsi *scsi\_num\_arg*

(Optional) Specifies the SCSI LUN ID to assign to this virtual disk on the given host. The *scsi\_num\_arg* parameter contains the SCSI LUN ID that is assigned to the VDisk on the given host. You must check your host system for the next available SCSI LUN ID on the given HBA. If you do not specify the **-scsi** parameter, the next available SCSI LUN ID is provided to the host.

#### *vdisk\_name* | *vdisk\_id*

(Required) Specifies the name of the virtual disk that you want to map to the host, either by ID or by name.

### Description

This command creates a new mapping between the virtual disk and the specified host. The virtual disk is presented to the host as if the disk is directly attached to the host. It is only after this command is processed, that the host can perform I/O transactions to the virtual disk.

Optionally, you can assign a SCSI LUN ID to the mapping. When the HBA in the host scans for devices that are attached to it, it discovers all virtual disks that are mapped to its Fibre Channel ports. When the devices are found, each one is allocated an identifier (SCSI LUN ID). For example, the first disk found is usually SCSI LUN 1, and so on. You can control the order in which the HBA discovers virtual disks by assigning the SCSI LUN ID, as required. If you do not specify a SCSI LUN ID, the cluster automatically assigns the next available SCSI LUN ID, if any mappings already exist with that host. When you issue the **mkvdiskhostmap** command, the assigned SCSI LUN ID number is returned.

Some HBA device drivers will stop when they find a gap in the SCSI LUN IDs. For example:

- Virtual Disk 1 is mapped to Host 1 with SCSI LUN ID 1
- Virtual Disk 2 is mapped to Host 1 with SCSI LUN ID 2
- Virtual Disk 3 is mapped to Host 1 with SCSI LUN ID 4

When the device driver scans the HBA, it must stop after identifying virtual disks 1 and 2, because no SCSI LUN is mapped with ID 3. For optimal performance, ensure that the SCSI LUN ID allocation is contiguous.

You can create multiple VDisk assignments. Normally, multiple VDisk-to-host assignments are not used because corruption is likely to occur if more than one host can access a disk. However, in certain multiple

path environments, such as in the IBM SAN File System, a VDisk must be mapped to more than one host. To map to more than one host, you must use the **mkvdiskhostmap** command with the **force** parameter. For example:

```
mkvdiskhostmap -host host1 -force 4
mkvdiskhostmap -host host2 -force 4
```

These commands create two host-to-VDisk mappings for VDisk 4 that map to host1 and host2. Omitting the **force** parameter causes the mapping to fail if that VDisk is already mapped to a host.

The command also fails if the host object (to which this mapping is being made) is not associated with the I/O group containing the VDisk.

### An invocation example

```
mkvdiskhostmap -host host1 -scsi 1 5
```

### The resulting output

```
Virtual Disk to Host map, id [1], successfully created
```

---

## recovervdisk

The **recovervdisk** command acknowledges VDisk data loss and brings the VDisk back online.

### Syntax

```
►► recovervdisk [-copy copy_id] vdisk_name | vdisk_id ◀◀
```

### Parameters

*vdisk\_name* | *vdisk\_id*

(Required) Specifies the virtual disk to recover.

**-copy** *copy\_id*

(Optional) Specifies the ID of the copy to recover.

### Description

The specified VDisk, and all copies if mirrored, are recovered and brought back online. If the VDisk is space-efficient or has space-efficient copies, this command triggers the space-efficient repair process. If the VDisk is mirrored, the **recovervdisk** command triggers a resynchronization from a synchronized copy. The progress of the resynchronization can be monitored using the **lsvdisksyncprogress** command. The VDisk remains online during the resynchronization process.

The **recovervdisk** command also starts the repair of any space-efficient copies that have a `fast_write_state` of corrupt. The progress of the repair process can be monitored using the **lsrepairsevdiskcopyprogress** command.

A VDisk that is still offline because it is being repaired following the **recovervdisk** command has a `fast_write_state` of repairing. The VDisk is brought online when the repair process is complete.

### An invocation example (to recover VDisk 45)

```
recovervdisk vdisk45
```

### An invocation example (to recover copy 0 of VDisk 45)

```
recovervdisk -copy 0 vdisk45
```

---

## recovervdiskbycluster

The **recovervdiskbycluster** command acknowledges data loss for all volumes in the clustered system (system) with a `fast_write_state` of corrupt and brings the volumes back online.

### Syntax

▶▶—recovervdiskbycluster—▶▶

### Parameters

There are no parameters.

### Description

All volumes in the system that have a `fast_write_state` of corrupt; and all copies, if mirrored, are recovered and brought back online. If any of the volumes are space-efficient or have space-efficient copies, the **recovervdiskbycluster** command triggers the space-efficient repair process. If volumes are mirrored, the command triggers a resynchronization from a synchronized copy. The progress of the resynchronization can be monitored by using the **lsvdisksyncprogress** command. Volumes remain online during the resynchronization process.

If none of the volumes in the system have a `fast_write_state` of corrupt, the **recovervdiskbycluster** command still starts the repair process for any corrupt copies of mirrored volumes. The progress of the repair process can be monitored using the **lsrepairsevdiskcopyprogress** command. If there are no corrupt volumes or no repairs to copies are required, no error is returned.

Volumes that are still offline because they are being repaired following the **recovervdiskbycluster** command have a `fast_write_state` of repairing. Volumes are brought online when the repair process is complete.

### An invocation example

```
recovervdiskbycluster
```

### The resulting output

No feedback

---

## recovervdiskbyiogrp

The **recovervdiskbyiogrp** command acknowledges data loss for all VDisks in the specified I/O group with a `fast_write_state` of corrupt and brings the VDisks back online.

### Syntax

▶▶—recovervdiskbyiogrp—  
          ┌ *io\_group\_name* ───▶▶  
          └ *io\_group\_id* ───▶▶

### Parameters

*io\_group\_name* | *io\_group\_id*  
(Required) Specifies the I/O group for virtual disk recovery.

## Description

All VDisks in the specified I/O group that have a `fast_write_state` of `corrupt`; and all copies, if mirrored, are recovered and brought back online. If any of the VDisks are `space_efficient` or have `space_efficient` copies, the `recovervdiskbyiogrp` command triggers the space-efficient repair process. If VDisks are mirrored, the command triggers a resynchronization from a synchronized copy. The progress of the resynchronization can be monitored by using the `lsvdisksyncprogress` command. VDisks remain online during the resynchronization process.

If none of the VDisks in the specified I/O group have a `fast_write_state` of `corrupt`, the `recovervdiskbyiogrp` command still starts the repair process for any corrupt copies of mirrored VDisks. The progress of the repair process can be monitored using the `lsrepairsevdiskcopyprogress` command. If there are no corrupt VDisks or no repairs to copies are required, no error is returned.

VDisks that are still offline because they are being repaired following the `recovervdiskbyiogrp` command have a `fast_write_state` of `repairing`. VDisks are brought online when the repair process is complete.

### An invocation example

```
recovervdiskbyiogrp iogrp2
```

### The resulting output

No feedback

---

## repairsevdiskcopy

The `repairsevdiskcopy` command repairs the metadata on a space-efficient volume.

## Syntax

```
▶▶—repairsevdiskcopy— [-copy — 0 | 1] [vdisk_name | vdisk_id] ▶▶
```

## Parameters

`-copy 0 | 1`

(Optional) Specifies the volume copy to repair.

`vdisk_name | vdisk_id`

(Required) Specifies the volume to repair.

## Description

The `repairsevdiskcopy` command repairs the metadata on a space-efficient volume. Run this command only when you are directed by the fix procedures or by IBM support.

Running the command automatically detects corrupted metadata. The command holds the volume offline during the repair, but does not prevent the disk from being moved between I/O groups.

If a repair operation completes successfully and the volume was previously offline because of corrupted metadata, the command brings the volume back online. The only limit on the number of concurrent repair operations is the number of virtual disk copies in the configuration. Once started, a repair operation cannot be paused or canceled; the repair can only be ended by deleting the copy.

### An invocation example

```
repairsevdiskcopy vdisk8
```



## The resulting output

No feedback

---

## repairvdiskcopy

The **repairvdiskcopy** command detects and optionally, corrects any volume copies that are not identical.

### Syntax

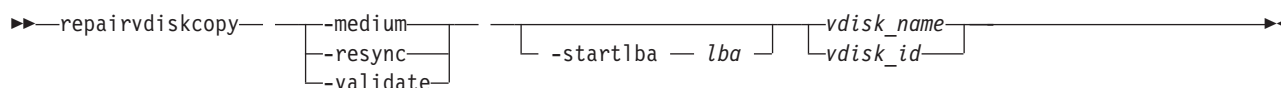

### Parameters

#### **-medium**

(Optional) Converts sectors that contain different contents into virtual medium errors on the specified volume. This parameter cannot be used with the **-validate** and **-resync** parameters; you must enter one of the three parameters.

#### **-resync**

(Optional) Corrects sectors that contain different contents by copying contents from the primary volume copy to other copies on the specified volume. This parameter cannot be used with the **-medium** and **-validate** parameters; you must enter one of the three parameters.

#### **-validate**

(Optional) Reports the first difference found on synchronized online copies of the specified volume, on or after the specified **-startlba** value. This parameter cannot be used with the **-medium** and **-resync** parameters; you must enter one of the three parameters.

#### **-startlba lba**

| (Optional) Specifies a starting logical block address (LBA) on which to begin the command. The LBA  
| must be specified in hex, with a 0x prefix.

#### *vdisk\_name* | *vdisk\_id*

(Required) Specifies the virtual disk to repair. You must specify this parameter last on the command line.

### Description

The **repairvdiskcopy** command detects and optionally, corrects any volume copies that are not identical. The results are logged to the SAN Volume Controller error log. The **-validate** parameter compares synchronized online copies of the specified volume. The **-medium** parameter changes any sectors that are not identical into virtual medium errors. The **-resync** parameter copies any sectors that are not identical to the other volume copies. You must specify only one of the three parameters.

### Attention:

1. Before you run the **repairvdiskcopy** command, ensure that all volume copies are synchronized.
2. Only one **repairvdiskcopy** command can run on a volume at a time. You must wait for the **repairvdiskcopy** command to complete processing before running the command again.
3. Once you start the **repairvdiskcopy** command, you cannot use the command to stop processing.
4. The primary copy of a mirrored volume cannot be changed while the **repairvdiskcopy -resync** command is running.

Use the **-startlba** parameter to specify a starting Logical Block Address (LBA). Enter an LBA value from 0 - full disk size minus one. The parameter logs the first error found and then stops the command. By repeating this parameter, you can collect all of the instances where the volume copies are not identical.

During **repairvdiskcopy** command operation, the volume remains online. The I/O and synchronization operations are allowed while the command is in progress.

The rate for the **repairvdiskcopy** command is controlled by the synchronization rate of the volume that is being repaired. To suspend the repair process, set the synchronization rate of the volume to 0 using the **chvdisk** command.

### An invocation example

```
| repairvdiskcopy -resync -startlba 0x0 vdisk8
```

### The resulting output

No feedback

---

## rmvdisk

The **rmvdisk** command deletes a volume.

### Syntax

```
▶▶ rmvdisk — [-force] [vdisk_id | vdisk_name] ▶▶
```

### Parameters

#### -force

(Optional) Deletes the specified volume, even if mappings still exist between this volume and one or more hosts. This parameter deletes any host-to-volume mappings and any FlashCopy mappings that exist for this volume. If the **-force** deletion of a volume causes dependent mappings to be stopped, any target volumes for those mappings that are in Metro Mirror or Global Mirror relationships are also stopped. The dependent mappings can be identified by using the **lsvdiskdependentmaps** command on the volume that you want to delete.

*vdisk\_id* | *vdisk\_name*

Specifies the name of the volume to delete, either by ID or by name.

### Description

This command deletes an existing managed mode volume or an existing image mode volume. The extents that made up this volume are returned to the pool of free extents that are available on the managed disk group, if the volume is in managed mode.

**Attention:** Any data that was on the volume is lost. Before you issue this command, ensure that the volume (and any data that resides on it) is no longer required.

## Deleting a managed mode volume

When you use this command to delete a managed mode volume, all the data on the volume is deleted. The extents that make up the volume are returned to the pool of free extents that are available in the managed disk group.

If host mappings exist for the volume, or if any FlashCopy mappings would be affected, the deletion fails. You can use the **-force** parameter to force the deletion. If you use the **-force** parameter, mappings that have the volume as source or target are deleted, other mappings in a cascade might be stopped, and then the volume is deleted. The **-force** parameter also deletes any Metro Mirror or Global Mirror relationships that exist for the specified volume.

If the volume is in the process of migrating to an image mode volume (using the **migratetoimage** command), the deletion fails unless you use the **-force** parameter. If you use the **-force** parameter, the migration is halted and then the volume is deleted. Before you issue this command, ensure that the volume (and any data that resides on it) is no longer required.

## Deleting an image mode volume

If the volume is mirrored and one or both copies is in image mode, you must first wait for all fast-write data to be moved to the controller logical unit. This ensures that the data on the controller is consistent with the data on the image mode volume before the volume is deleted. This process can take several minutes to complete, and is indicated by the *fast\_write\_state* state of the volume being **empty**. If the **-force** parameter is specified, the fast-write data is discarded and the volume is deleted immediately; the data on the controller logical unit is left inconsistent and unusable. If the copies are not synchronized, you must use the **-force** parameter.

If you run the command while data is in the cache, SVC attempts to move the data out of the cache; this process can time out, however.

If there are any virtual medium errors on the volume, the command fails. You can force the deletion by using the **-force** parameter; however, this can cause data integrity problems.

**Note:** A virtual medium error occurs when you copy data from one disk (the source) to another (the target). Reading the source indicates that there is a medium error. At that moment, you must have two identical copies of data and you must then simulate a medium error on the target disk. You can simulate a medium error on the target disk by creating a virtual medium error on the target disk.

If FlashCopy mappings or host mappings exist for the volume, the deletion fails unless you use the **-force** parameter. If you use the **-force** parameter, mappings are deleted and the volume is deleted. If there is any data that is not staged in the fast write cache for this volume, the deletion of the volume fails. When the **-force** parameter is specified, any data that is not staged in the fast write cache is deleted. Deleting an image mode volume causes the managed disk that is associated with the volume to be removed from the managed disk group. The mode of the managed disk is returned to “unmanaged.”

### An invocation example

```
rmvdisk -force vdisk5
```

### The resulting output

```
No feedback
```

---

## rmvdiskcopy

The **rmvdiskcopy** command removes a VDisk copy from a VDisk.

## Syntax

```
►► rmdiskcopy --copy copy_id [-force] [vdisk_name | vdisk_id]
```

## Parameters

**-copy** *copy\_id*

(Required) Specifies the ID of the copy to delete.

**-force**

(Optional) Forces the deletion of the last synchronized copy of a VDisk, which deletes the entire VDisk. The parameter also forces the deletion of a nonmirrored VDisk, a copy that is migrating to image mode, or an image-mode copy that has virtual medium errors.

*vdisk\_name* | *vdisk\_id*

(Required) Specifies the virtual disk to delete the copy from. You must specify this parameter last on the command line.

## Description

The **rmdiskcopy** command deletes the specified copy from the specified VDisk. The command fails if all other copies of the VDisk are not synchronized; in this case, you must specify the **-force** parameter, delete the VDisk, or wait until the copies are synchronized.

### An invocation example

```
rmdiskcopy -copy 1 vdisk8
```

### The resulting output

No feedback

---

## rmdiskhostmap

The **rmdiskhostmap** command deletes an existing volume-to-host mapping; the volume is no longer accessible for I/O transactions on the given host.

## Syntax

```
►► rmdiskhostmap -- -host [host_id | host_name] [vdisk_id | vdisk_name]
```

## Parameters

**-host** *host\_id* | *host\_name*

(Required) Specifies the host that you want to remove from the map with the volume, either by ID or by name.

*vdisk\_id* | *vdisk\_name*

(Required) Specifies the name of the volume that you want to remove from the host mapping, either by ID or by name.

## Description

This command deletes an existing mapping between the specified volume and the host. This effectively stops the volume from being available for I/O transactions on the given host.

This command also deletes a SCSI or persistent reservation that a host has on a volume. Once the reservation is removed, a new host is allowed to access the volume in the future because the original host no longer has access.

Use caution when you process this command because to the host, it seems as if the volume has been deleted or is offline.

### An invocation example

```
rmvdiskhostmap -host host1 vdisk8
```

### The resulting output

No feedback

---

## shrinkvdisksize

The **shrinkvdisksize** command reduces the size of a VDisk by the specified capacity.

### Syntax

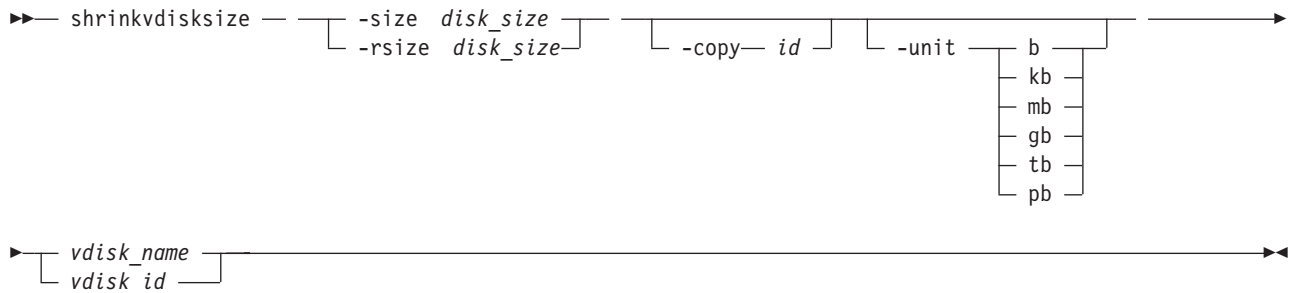

### Parameters

#### **-size** *disk\_size*

(Required) Specifies the size reduction for the designated virtual disk. The **-size** parameter cannot be used with the **-rsize** parameter. You must specify either **-size** or **-rsize**.

#### **-rsize** *disk\_size*

(Optional) Reduces the real size of a space-efficient VDisk by the specified amount. Specify the *disk\_size* value using an integer. Specify the units for a *disk\_size* integer using the **-unit** parameter; the default is MB. The **-rsize** value can be greater than, equal to, or less than the size of the VDisk. You must specify either the **-size** parameter or the **-rsize** parameter.

#### **-copy** *id*

(Optional) Specifies the copy to change the real capacity for. You must also specify the **-rsize** parameter. If the **-copy** parameter is not specified, all copies of the VDisk are reduced. This parameter is required if the VDisk is mirrored and only one copy is space-efficient.

#### **-unit** **b** | **kb** | **mb** | **gb** | **tb** | **pb**

(Optional) Specifies the data units to be used in conjunction with the value that is specified by the **-size** parameter.

#### *vdisk\_name* | *vdisk\_id*

(Required) Specifies the virtual disk that you want to modify, either by ID or by name.

### Description

The **shrinkvdisksize** command reduces the capacity that is allocated to the particular virtual disk by the amount that you specify. You cannot shrink the real size of a space-efficient volume below its used size.

All capacities, including changes, must be in multiples of 512 bytes. An entire extent is reserved even if it is only partially used. The default capacity units are MB.

The command can be used to shrink the physical capacity that is allocated to a particular VDisk by the specified amount. The command can also be used to shrink the virtual capacity of a space-efficient VDisk without altering the physical capacity assigned to the VDisk. To change the capacity of a non-space-efficient disk, use the **-size** parameter. To change the real capacity of a space-efficient disk, use the **-rsize** parameter. To change the virtual capacity of a space-efficient disk, use the **-size** parameter.

VDisks can be reduced in size, if required.

When the virtual size of a space-efficient VDisk is changed, the warning threshold is automatically scaled to match. The new threshold is stored as a percentage.

To run the **shrinkvdisksize** command on a mirrored VDisk, all copies of the VDisk must be synchronized.

**Attention:** If the VDisk contains data that is being used, do not shrink the VDisk without backing up the data first.

The cluster arbitrarily reduces the capacity of the VDisk by removing a partial, one or more extents from those allocated to the VDisk. You cannot control which extents are removed and so you cannot assume that it is unused space that is removed.

**Attention:**

1. If the virtual disk contains data, do not shrink the disk.
2. Some operating systems or file systems use what they consider to be the outer edge of the disk for performance reasons. This command can shrink FlashCopy target virtual disks to the same capacity as the source.
3. Before you shrink a VDisk, validate that the VDisk is not mapped to any host objects. If the VDisk is mapped, data is displayed. You can determine the exact capacity of the source or master VDisk by issuing the **lsvdisk -bytes *vdiskname*** command. Shrink the VDisk by the required amount by issuing the **shrinkvdisksize -size *disk\_size* -unit *b | kb | mb | gb | tb | pb* *vdisk\_name* | *vdisk\_id*** command.

**An invocation example**

To decrease the capacity of vdisk1 by 2 KB, enter:

```
shrinkvdisksize -size 2048 -unit b vdisk1
```

**The resulting output**

No feedback

**An invocation example**

To decrease the capacity of vdisk2 by 100 MB, enter:

```
shrinkvdisksize -size 100 -unit mb vdisk2
```

**The resulting output**

No feedback

**An invocation example**

To decrease the real capacity of space-efficient VDisk vdisk3 by 100 MB without changing its virtual capacity, enter:

```
shrinkvdisksize -rsize 100 -unit mb vdisk3
```

### The resulting output

No feedback

### An invocation example

To decrease the real capacity of space-efficient VDisk copy ID 1 of mirrored VDisk vdisk4 by 100 MB, enter:

```
shrinkvdisksize -rsize 100 -unit mb -copy 1 vdisk4
```

### The resulting output

No feedback

### An invocation example

To decrease the virtual capacity of space-efficient VDisk vdisk5 by 1 GB without changing its real capacity, enter:

```
shrinkvdisksize -size 1 -unit gb vdisk5
```

### The resulting output

No feedback

---

## splitvdiskcopy

The `splitvdiskcopy` command creates a separate VDisk from a synchronized copy of a mirrored VDisk.

### Syntax

```
▶▶—splitvdiskcopy— — -copy — id — [-iogrp — io_group_id | io_group_name]
▶ [-node — node_id | node_name] [-name — new_name] [-cache — readwrite | none]
▶ [-udid — udid] [-force] [vdisk_name / vdisk_id]
```

### Parameters

#### **-copy** *id*

(Required) Specifies the ID of the copy to split.

#### **-iogrp** *io\_group\_id* | *io\_group\_name*

(Optional) Specifies the I/O group to add the new virtual disk to. The default is the I/O group of the specified VDisk.

#### **-node** *node\_id* | *node\_name*

(Optional) Specifies the preferred node ID or the name for I/O operations to this virtual disk. You can use the **-node** parameter to specify the preferred access node.

#### **-name** *new\_name*

(Optional) Assigns a name to the new virtual disk.

#### **-cache** *readwrite* | *none*

(Optional) Specifies the caching options for the new virtual disk. Enter **readwrite** or **none**; the default is **readwrite**.

**-udid** *udid*

(Optional) Specifies the *udid* for the new VDisk. The *udid* is a required identifier for OpenVMS hosts; no other hosts use this parameter. Supported values are a decimal number 0 - 32 767, or a hexadecimal number 0 - 0x7FFF. A hexadecimal number must be preceded by **0x**; for example, **0x1234**. The default *udid* value is **0**.

**-force**

(Optional) Allows the split to proceed even when the specified copy is not synchronized, or even when the cache flush is likely to fail. The newly created VDisk might not be consistent.

## Description

The **splitvdiskcopy** command creates a new VDisk in the specified I/O Group from a copy of the specified VDisk. If the copy that you are splitting is not synchronized, you must use the **-force** parameter. The command fails if you are attempting to remove the only synchronized copy. To avoid this, wait for the copy to synchronize or split the unsynchronized copy from the VDisk by using the **-force** parameter. You can run the command when either VDisk copy is offline.

### An invocation example

```
splitvdiskcopy -copy 1 vdisk8
```

### The resulting output

```
Virtual Disk, id [1], successfully created.
```



---

## Chapter 30. Command-line interface messages

---

**CMMVC5000I** No message was found for major rc *MAJOR\_RC* , minor rc *MINOR\_RC* , for action/view id *ACTION\_VIEW\_ID* .

**Explanation:** A message is missing.

**User response:** Contact the support center.

---

**CMMVC5700E** The parameter list is not valid.

**Explanation:** You have entered a list of parameters that is not supported for the command.

**User response:** Specify a parameter list that is supported for the command, and resubmit the command.

---

**CMMVC5701E** No object ID was specified.

**Explanation:** The command that you have submitted requires that you specify an object identifier name or ID number, and you did not specify an object identifier.

**User response:** Specify an object ID, and resubmit the command.

---

**CMMVC5702E** *VALUE* is below the minimum level.

**Explanation:** You entered the specified string as a value for a parameter. The parameter requires a minimum value, and the specified string is less than the required minimum value.

**User response:** Specify a value that is supported by the parameter, and resubmit the command.

---

**CMMVC5703E** The value or list starting with *VALUE* is above the maximum permitted for that value or has exceeded the number of items allowed in a list.

**Explanation:** You have entered the specified string as a value for a parameter. The string is either a standalone value or the first value in a list of values. If the string is a standalone value, the value is greater than the supported maximum value for the parameter. If the string is the first value in a list of values, the list contains more than the supported maximum number of entries for the parameter.

**User response:** Specify a value or list of values that is supported by the parameter, and resubmit the command.

---

**CMMVC5704E** *VALUE* is not divisible by the permitted step value.

**Explanation:** You have entered the specified string as

a value for a parameter. The string is not a supported value for the parameter. One requirement is that the value is an even multiple of 16, and the specified string does not meet that requirement.

**User response:** Specify a value that is supported by the parameter, and resubmit the command.

---

**CMMVC5705E** A required parameter is missing.

**Explanation:** The command that you have submitted has at least one required parameter that you have not entered.

**User response:** Specify all of the required parameters, and resubmit the command.

---

**CMMVC5706E** An invalid argument has been entered for the *PARAMETER* parameter.

**Explanation:** You have entered a value for the specified parameter and the value is not supported for the parameter. The parameter supports a specific set of values.

**User response:** Specify a value that is supported by the parameter, and resubmit the command.

---

**CMMVC5707E** Required parameters are missing.

**Explanation:** The command that you have submitted has more than one required parameter that you have not entered.

**User response:** Specify all of the required parameters, and resubmit the command.

---

**CMMVC5708E** The *PARAMETER* parameter is missing its associated arguments.

**Explanation:** You have entered the specified parameter without an associated value. This parameter, like most parameters, requires an associated value.

**User response:** Specify the associated value, and resubmit the command.

---

**CMMVC5709E** *VALUE* is not a supported parameter.

**Explanation:** The specified string is not a supported parameter for the command that you have entered.

**User response:** Specify the correct parameter, and resubmit the command.

---

**CMMVC5711E** *VALUE* is not valid data.

**Explanation:** You have entered the specified string as

## CMMVC5712E • CMMVC5723E

a value for a parameter. The string is not a supported value for the parameter.

**User response:** Specify a value that is supported by the parameter, and resubmit the command.

---

### CMMVC5712E Required data is missing.

**Explanation:** You have entered an incomplete command.

**User response:** Specify command completely, and resubmit the command.

---

### CMMVC5713E Some parameters are mutually exclusive.

**Explanation:** Certain commands have two or more parameters that are mutually exclusive. You have submitted a command using at least two mutually exclusive parameters.

**User response:** Specify a supported combination of parameters, and resubmit the command.

---

### CMMVC5714E The parameter list is empty.

**Explanation:** Certain parameters require one or more values in a colon separated parameter list. You have specified at least one parameter without the required parameter list.

**User response:** Specify at least one value for all parameters that require a value, and resubmit the command.

---

### CMMVC5715E The parameter list does not exist.

**Explanation:** Certain parameters require one or more values in a colon separated parameter list. You have specified at least one parameter without the required parameter list.

**User response:** Specify at least one value for all parameters that require a value, and resubmit the command.

---

### CMMVC5716E Non-numeric data was entered for the numeric field *FIELD*. Enter a numeric value.

**Explanation:** You have entered the specified string as a value for a parameter that supports only numeric values.

**User response:** Specify a numeric value in the numeric field, and resubmit the command.

---

### CMMVC5717E No match was found for the specified unit.

**Explanation:** Certain parameters allow a user to specify a data unit such as mb or kb. You have entered a data unit for a parameter that supports data units, but the data unit that you have entered is not a supported data unit for the parameter.

**User response:** Specify the correct data unit, and resubmit the command.

---

### CMMVC5718E An unexpected return code was received.

**Explanation:** The command has completed, but the acknowledgement of the command completion contains a return code that is not defined.

**User response:** Determine whether or not the command has succeeded. If the command has not succeeded, resubmit the command. If the problem persists, contact IBM technical support for assistance.

---

### CMMVC5719E A value of *VALUE* requires the parameter *PARAMETER* to be specified.

**Explanation:** Certain commands have required combinations of parameters based on either the entry of a parameter or the value for a parameter. When you enter the specified value, you must enter the specified parameter.

**User response:** Specify the required parameter, and resubmit the command.

---

### CMMVC5721E *VALUE* is not a valid time stamp format. The valid time stamp format is YYMMDDHHMMSS.

**Explanation:** The specified value is not a valid time stamp format. The valid format is YYMMDDHHMMSS.

**User response:** Use the correct time stamp format, and resubmit the command.

---

### CMMVC5722E *VALUE* contains a month value that is not valid. The valid time stamp format is YYMMDDHHMMSS.

**Explanation:** The month value (MM) that you have specified is not valid.

**User response:** Specify a valid month value, and resubmit the command.

---

### CMMVC5723E *VALUE* contains a day value that is not valid. The valid time stamp format is YYMMDDHHMMSS.

**Explanation:** The day value (DD) that you have specified is not valid.

**User response:** Specify a valid day value, and resubmit the command.

---

**CMMVC5724E** *VALUE* contains an hour value that is not valid. The valid time stamp format is YYMMDDHHMMSS.

**Explanation:** The hour value (HH) that you have specified is not valid.

**User response:** Specify a valid hour value, and resubmit the command.

---

**CMMVC5725E** *VALUE* contains a minutes value that is not valid. The valid time stamp format is YYMMDDHHMMSS.

**Explanation:** The minutes value (MM) that you have specified is not valid.

**User response:** Specify a valid minutes value, and resubmit the command.

---

**CMMVC5726E** *VALUE* contains a seconds value that is not valid. The valid time stamp format is YYMMDDHHMMSS.

**Explanation:** The seconds value (SS) that you have specified is not valid.

**User response:** Specify a valid seconds value, and resubmit the command.

---

**CMMVC5727E** *VALUE* is not a valid filter.

**Explanation:** You can filter the output of some views by using the `-filtervalue` parameter. The specified string that you have entered is not a supported value for the `-filtervalue` parameter in this view.

**User response:** Ensure that you use a supported value for the `-filtervalue` parameter, and resubmit the command.

---

**CMMVC5728E** *VALUE* should be in the format minute:hour:day:month:weekday.

**Explanation:** The specified value should be in the format minute:hour:day:month:weekday.

**User response:** Follow the correct format, and resubmit the command.

---

**CMMVC5729E** One or more components in the list is not valid.

**Explanation:** Certain parameters support one or more items of data in a colon separated list. At least one of the items in the list that you have entered is not correct.

**User response:** Ensure that you enter supported values in the list, and resubmit the command.

---

**CMMVC5730E** *VALUE* is only valid when *VALUE* has a value of *VALUE*.

**Explanation:** The specified command and parameter combination that you have entered requires the specified parameter value.

**User response:** Ensure that you specify the correct parameter value for the command and parameter combination that you enter, and resubmit the command.

---

**CMMVC5731E** *VALUE* can only be entered when *VALUE* has been entered.

**Explanation:** Certain commands have required combinations of parameters based either on the inclusion of a specified parameter, or on the value entered for a specified parameter. When you include the first specified string in the command, you must enter the second specified string as a parameter.

**User response:** Ensure that you enter a supported combination or parameters and values, and resubmit the command.

---

**CMMVC5732E** The command cannot be initiated because it was not run on the configuration node.

**Explanation:** The command that you have specified must be run on the configuration node.

**User response:** Log off of the node service IP address, log on to the management IP address, and run the command on the configuration node.

---

**CMMVC5733E** Enter at least one parameter.

**Explanation:** You must specify at least one parameter for the command that you have submitted.

**User response:** Specify at least one parameter, and resubmit the command.

---

**CMMVC5734E** A combination of values was entered that is not valid.

**Explanation:** You have specified a combination of values that is not correct.

**User response:** Specify a supported combination of values, and resubmit the command.

---

**CMMVC5735E** The name entered is not valid. Enter an alphanumeric string that does not start with a number.

**Explanation:** The first character of an object name cannot be numeric.

**User response:** Specify an alphanumeric string that

## CMMVC5737E • CMMVC5748E

does not start with a numeric, and resubmit the command.

---

**CMMVC5737E** The parameter *PARAMETER* has been entered multiple times. Enter the parameter only one time.

**Explanation:** The specified parameter was entered more than once.

**User response:** Delete all duplicate parameters, and resubmit the command.

---

**CMMVC5738E** The argument *ARGUMENT* contains too many characters.

**Explanation:** The field length of the specified argument is longer than the maximum supported field length for the argument.

**User response:** Specify the correct argument, and resubmit the command.

---

**CMMVC5739E** The argument *ARGUMENT* does not contain enough characters.

**Explanation:** The field length of the specified argument is less than the minimum supported field length for the argument.

**User response:** Specify the correct argument, and resubmit the command.

---

**CMMVC5740E** The filter flag *VALUE* is not valid.

**Explanation:** You can filter the output of some views by using the `-filtervalue` parameter. The specified string that you have entered is not a supported value for the `-filtervalue` parameter in this view.

**User response:** Ensure that you use a supported value for the `-filtervalue` parameter, and resubmit the command.

---

**CMMVC5741E** The filter value *VALUE* is not valid.

**Explanation:** You can filter the output of some views by using the `-filtervalue` parameter. Each filter has an associated value. The syntax is `-filtervalue filter=value`. The specified string that you have entered is not a supported value for the `-filtervalue` filter that you specified in this view.

**User response:** Ensure that you use a supported value for the `-filtervalue` filter that you specify, and resubmit the command.

---

**CMMVC5742E** A specified parameter is out of its valid range.

**Explanation:** You have entered data that is not in the range of values that is supported for the parameter that you have entered.

**User response:** Ensure that you enter data values that are supported for the parameter that you enter, and resubmit the command.

---

**CMMVC5743E** A specified parameter does not comply with the step value.

**Explanation:** A parameter was specified that does not comply with the step value.

**User response:** Specify the correct parameter, and resubmit the command.

---

**CMMVC5744E** Too many objects were specified in the command.

**Explanation:** There were too many objects specified in the command.

**User response:** Specify the correct object, and resubmit the command.

---

**CMMVC5745E** Too few objects were specified in the request.

**Explanation:** There were not enough objects specified in the command.

**User response:** Specify the correct object, and resubmit the command.

---

**CMMVC5746E** The requested operation cannot be applied to the object specified.

**Explanation:** The requested operation is not valid for this object.

**User response:** Specify a valid operation, and resubmit the command.

---

**CMMVC5747E** The action requested is invalid - internal error.

**Explanation:** The operation that was requested is not valid.

**User response:** Specify the correct operation, and resubmit the command.

---

**CMMVC5748E** The action requested is invalid - internal error.

**Explanation:** The operation that was requested is not valid.

**User response:** Specify the correct operation, and resubmit the command.

---

**CMMVC5749E** The dump filename specified already exists.

**Explanation:** The dump file name that was specified already exists.

**User response:** Specify a different dump file name, and resubmit the command.

---

**CMMVC5750E** The dump file could not be created - the file system is probably full.

**Explanation:** The dump file was not created. The file system might be full.

**User response:** Not applicable.

---

**CMMVC5751E** The dump file could not be written to.

**Explanation:** The dump file could not be written to disk.

**User response:** Not applicable.

---

**CMMVC5752E** Request failed. The object contains child objects, these must be deleted first.

**Explanation:** The operation failed because the specified object contains child objects.

**User response:** Delete the child objects, and resubmit the command.

---

**CMMVC5753E** The specified object does not exist or is not a suitable candidate.

**Explanation:** The specified object does not exist or is not a suitable candidate.

**User response:** Specify the correct object, and resubmit the command.

---

**CMMVC5754E** The specified object does not exist, or the name supplied does not meet the naming rules.

**Explanation:** The specified object does not exist, or the name of the object does not meet the naming requirements.

**User response:** Specify the correct object name, and resubmit the command.

---

**CMMVC5755E** Cannot create as the sizes of the specified objects do not match.

**Explanation:** The sizes of the specified objects do not match.

**User response:** Not applicable.

---



---

**CMMVC5756E** Cannot perform the request as the object id is already mapped to another object or is the subject of an FC or RC relationship.

**Explanation:** The operation failed because the specified object is already mapped.

**User response:** Specify a different object, and resubmit the command.

---

**CMMVC5757E** Self Defining Structure (SDS) defaults not found - internal error.

**Explanation:** The defaults for the self describing structure were not found.

**User response:** Not applicable.

---

**CMMVC5758E** Object name already exists.

**Explanation:** The object name already exists.

**User response:** Specify a unique object name, and resubmit the command.

---

**CMMVC5759E** An internal error has occurred - memory could not be allocated.

**Explanation:** The memory cannot be allocated.

**User response:** Not applicable.

---

**CMMVC5760E** Failed to add the node to the cluster member list.

**Explanation:** The node could not be added to the cluster.

**User response:** Not applicable.

---

**CMMVC5761E** Failed to delete the node from the cluster member list.

**Explanation:** The node could not be deleted from the cluster.

**User response:** Not applicable.

---

**CMMVC5762E** The request did not complete before the timeout period expired.

**Explanation:** The operation failed because the timeout period expired.

**User response:** Resubmit the command.

---

**CMMVC5763E** The node failed to go online.

**Explanation:** The node failed to go online.

**User response:** Not applicable.

---

---

**CMMVC5764E** The mode change request is invalid - internal error

**Explanation:** The specified mode change is not valid.

**User response:** Specify a different mode, and resubmit the command.

---

**CMMVC5765E** The object specified is no longer a candidate - a change occurred during the request.

**Explanation:** The specified object is no longer a candidate. A change occurred during the request.

**User response:** Specify a different object, and resubmit the command.

---

**CMMVC5767E** One or more of the parameters specified are invalid or a parameter is missing.

**Explanation:** One or more of the specified parameters is not valid.

**User response:** Specify the correct parameter, and resubmit the command.

---

**CMMVC5769E** The requested operation requires all nodes to be online - one or more nodes are not online.

**Explanation:** The operation requires that all nodes be online. One or more nodes are not online.

**User response:** Check that each node is online, and resubmit the command.

---

**CMMVC5770E** The SSH key file supplied is invalid.

**Explanation:** The file for the SSH key is not valid.

**User response:** Specify a different file, and resubmit the command.

---

**CMMVC5771E** The operation requested could not complete, usually due to child objects existing. To force the operation, specify the force flag.

**Explanation:** The operation failed, probably, because the object contains child objects.

**User response:** Specify the -force flag to complete the operation, and resubmit the command.

---

**CMMVC5772E** The operation requested could not be performed because software upgrade is in progress.

**Explanation:** The operation failed because a software upgrade is in progress.

**User response:** Wait for the software upgrade to

complete, and resubmit the command.

---

**CMMVC5773E** The object selected is in the wrong mode to perform the requested operation.

**Explanation:** The operation failed because the selected object is in the wrong mode.

**User response:** Specify the correct mode, and resubmit the command.

---

**CMMVC5774E** The userid supplied is not valid.

**Explanation:** The userid is not valid.

**User response:** Specify a different userid, and resubmit the command.

---

**CMMVC5775E** The directory attribute specified is not valid.

**Explanation:** The directory attribute is not valid.

**User response:** Specify a different directory, and resubmit the command.

---

**CMMVC5776E** The directory listing could not be retrieved.

**Explanation:** The directory listing could not be retrieved.

**User response:** Specify a different directory listing, and resubmit the command.

---

**CMMVC5777E** The node could not be added to the IO Group, because the other node in the IO Group is in the same power domain.

**Explanation:** The node was not added to the I/O group because the other node in the I/O Group is in the same power domain.

**User response:** Specify a different node from another I/O group, and resubmit the command.

---

**CMMVC5778E** Cannot create another cluster, a cluster already exists.

**Explanation:** The cluster was not created because one already exists.

**User response:** Not applicable.

---

**CMMVC5780E** The action could not be completed using the Remote Cluster name. Use the Remote Cluster Unique ID instead.

**Explanation:** The unique ID of the remote cluster is required for this command.

**User response:** Specify the unique ID of the remote cluster, and resubmit the command.

---

**CMMVC5781E** The cluster ID specified is invalid.

**Explanation:** The cluster ID is not valid.

**User response:** Specify a different cluster ID, and resubmit the command.

---

**CMMVC5782E** The object specified is offline.

**Explanation:** The object is offline.

**User response:** Specify an object that is online, and resubmit the command.

---

**CMMVC5783E** The information is not available to complete this command.

**Explanation:** This error is only returned when the node is in the service state.

**User response:** None.

---

**CMMVC5784E** The cluster name specified is not unique, specify the cluster using the cluster ID.

**Explanation:** The cluster name is not unique.

**User response:** Specify the cluster using the cluster ID, and resubmit the command.

---

**CMMVC5785E** The filename specified contains an illegal character.

**Explanation:** The filename contains an illegal character.

**User response:** Specify a valid filename, and resubmit the command.

---

**CMMVC5786E** The action failed because the cluster is not in a stable state.

**Explanation:** The action failed because the cluster is not in a stable state.

**User response:** Not applicable.

---

**CMMVC5787E** The cluster was not created because a cluster already exists.

**Explanation:** The cluster was not created because a cluster already exists.

**User response:** Not applicable.

---

**CMMVC5788E** The service IP address is not valid.

**Explanation:** The service IP address is not valid.

**User response:** Specify the correct service IP address, and resubmit the command.

---

---

**CMMVC5789E** The cluster was not modified because the IP address, subnet mask, service address, SNMP address, or gateway address is not valid.

**Explanation:** The cluster was not modified because the IP address, subnet mask, service address, SNMP address, or gateway address is not valid.

**User response:** Specify all correct attributes, and resubmit the command.

---

**CMMVC5790E** The node was not added to the cluster because the maximum number of nodes has been reached.

**Explanation:** The node was not added to the cluster because the maximum number of nodes has been reached.

**User response:** Not applicable.

---

**CMMVC5791E** The action failed because an object that was specified in the command does not exist.

**Explanation:** An entity that was specified in the command does not exist, therefore the action failed.

**User response:** Specify the correct entity, and resubmit the command.

---

**CMMVC5792E** The action failed because the I/O group is used for recovery.

**Explanation:** The action failed because the I/O group is used for recovery.

**User response:** Not applicable.

---

**CMMVC5793E** The node was not added to the cluster because the I/O group already contains a pair of nodes.

**Explanation:** The node was not added to the cluster because the I/O group already contains a pair of nodes.

**User response:** Not applicable.

---

**CMMVC5794E** The action failed because the node is not a member of the cluster.

**Explanation:** The node is not a member of the cluster, therefore the action failed.

**User response:** Specify a node that is contained in the cluster, and resubmit the command.

---

---

**CMMVC5795E** The node was not deleted because a software upgrade is in progress.

**Explanation:** The node was not deleted because a software upgrade is in progress.

**User response:** Wait for the software upgrade to complete, and resubmit the command.

---

**CMMVC5796E** The action failed because the I/O group that the node belongs to is unstable.

**Explanation:** A previous configuration command might not yet have completed.

**User response:** Wait for the previous command to complete, and resubmit the command.

---

**CMMVC5797E** The node was not deleted because this is the last node in the I/O group and there are virtual disks (VDisks) associated with the I/O group.

**Explanation:** The specified node is the last node in the I/O group and there are volumes associated with the I/O group, therefore the node could not be deleted.

**User response:** Not applicable.

---

**CMMVC5798E** The action failed because the node is offline.

**Explanation:** The action failed because the node is offline.

**User response:** Specify a node that is online, and resubmit the command.

---

**CMMVC5799E** The shut down was not successful because there is only one online node in the I/O group.

**Explanation:** There is only one online node in the I/O group, therefore the shut down operation was not successful.

**User response:** Not applicable.

---

**CMMVC5800E** The action failed because an entity that was specified in the command does not exist.

**Explanation:** The entity that was specified in the command does not exist, therefore the action failed.

**User response:** Specify a different entity, and resubmit the command.

---

**CMMVC5801E** The upgrade of the cluster software could not proceed because every node in the cluster must be online. Either delete the node that is offline or bring the node online and resubmit the command

**Explanation:** The upgrade of the cluster software could not proceed because every node in the cluster must be online.

**User response:** Either delete the node that is offline or bring the node online, and resubmit the command.

---

**CMMVC5802E** The upgrade of the cluster software could not proceed because there is an I/O group in the cluster that contains only one node. The software upgrade requires that each node in an I/O group be shut down and restarted. If there is only one node in an I/O group, I/O operations could be lost if I/O operations are not stopped before beginning the software upgrade.

**Explanation:** The upgrade of the cluster software could not proceed because there is an I/O group in the cluster that contains only one node. The software upgrade requires that each node in an I/O group be shut down and restarted. If there is only one node in an I/O group, I/O operations could be lost if I/O operations are not stopped before beginning the software upgrade.

**User response:** Either upgrade the cluster using the -force option or specify a different node, and resubmit the command.

---

**CMMVC5803E** The entry in the error log was not marked because the error is already fixed or unfixed, or the sequence number could not be found.

**Explanation:** The entry in the event log was not marked because the sequence number was not found.

**User response:** Not applicable.

---

**CMMVC5804E** The action failed because an object that was specified in the command does not exist.

**Explanation:** The entity that was specified in the command does not exist, therefore the action failed.

**User response:** Specify a different entity, and resubmit the command.

---

**CMMVC5805E** The progress information was not returned because the FlashCopy statistics are not ready yet.

**Explanation:** The progress information was not



returned because the FlashCopy statistics are not ready yet.

**User response:** Not applicable.

---

**CMMVC5806E** The action failed because an object that was specified in the command does not exist.

**Explanation:** The entity that was specified in the command does not exist, therefore the action failed.

**User response:** Specify a different entity, and resubmit the command.

---

**CMMVC5807E** The action failed because the managed disk (MDisk) cannot be changed to the specified mode.

**Explanation:** The action failed because the managed disk (MDisk) cannot be changed to the specified mode.

**User response:** Not applicable.

---

**CMMVC5808E** The action failed because the managed disk (MDisk) does not exist.

**Explanation:** The action failed because the managed disk (MDisk) does not exist.

**User response:** Specify a different MDisk, and resubmit the command.

---

**CMMVC5809E** The tracing of I/O operations was not started because it is already in progress.

**Explanation:** The tracing of I/O operations was not started because it is already in progress.

**User response:** Not applicable.

---

**CMMVC5810E** The action failed because the specified resource was unavailable.

**Explanation:** The resource specified in the action was not available for use.

**User response:** Fix any errors associated with the specified resource, or reissue the command using an alternative resource.

---

**CMMVC5811E** The quorum index number for the object was not set because the quorum disk does not exist.

**Explanation:** An existing quorum disk must be specified before the quorum index number of the object can be set.

**User response:** Specify an existing quorum disk, and resubmit the command.

---

**CMMVC5812E** The action failed because the managed disk (MDisk) is not in managed mode.

**Explanation:** The action is only permitted on MDisks that are currently in the managed mode.

**User response:** Either add the MDisk to a group, or specify a different MDisk.

---

**CMMVC5813E** The quorum index number for the object was not set because the object has a sector size that is not valid.

**Explanation:** The sector size of the specified object will not allow the quorum index number for the object to be set.

**User response:** Change the sector size of the specified object, or specify a different object, and resubmit the command.

---

**CMMVC5814E** The quorum index number for the managed disk (MDisk) was not set because quorum is not allowed on one or more associated controllers.

**Explanation:** The quorum index number for the managed disk (MDisk) was not set because quorum is not allowed on one or more associated controllers.

**User response:** Specify an MDisk that has quorum enabled on all of its associated controllers, and resubmit the command.

---

**CMMVC5815E** The managed disk group was not created because an entity that was specified in the command does not exist.

**Explanation:** The storage pool was not created because an entity that was specified in the command does not exist.

**User response:** Specify a different entity, and resubmit the command.

---

**CMMVC5816E** The action failed because an entity that was specified in the command does not exist.

**Explanation:** The action failed because an entity that was specified in the command does not exist.

**User response:** Specify a different entity, and resubmit the command.

---

**CMMVC5817E** The specified managed disk group was invalid.

**Explanation:** The storage pool was not renamed because the name was not valid.

**User response:** Specify a different storage pool name, and resubmit the command.

---

**CMMVC5818E** The managed disk group was not deleted because there is at least one MDisk in the group.

**Explanation:** The storage pool was not deleted because there is at least one MDisk in the group.

**User response:** Not applicable.

---

**CMMVC5819E** The managed disk (MDisk) was not added to the MDisk group because the MDisk is part of another MDisk group.

**Explanation:** The managed disk (MDisk) was not added to the storage pool because the MDisk is part of another storage pool.

**User response:** Not applicable.

---

**CMMVC5820E** The managed disk (MDisk) was not added to the MDisk group because an entity that was specified in the command does not exist.

**Explanation:** The managed disk (MDisk) was not added to the storage pool because an entity that was specified in the command does not exist.

**User response:** Specify a different entity, and resubmit the command.

---

**CMMVC5821E** The managed disk (MDisk) was not added to the MDisk group because not enough MDisks were included in the list.

**Explanation:** The managed disk (MDisk) was not added to the storage pool because not enough MDisks were included in the list.

**User response:** Include more MDisks in the list, and resubmit the command.

---

**CMMVC5822E** The managed disk (MDisk) was not added to the MDisk group because too many MDisks were included in the list.

**Explanation:** The managed disk (MDisk) was not added to the storage pool because too many MDisks were included in the list.

**User response:** Delete the extra MDisks in the list, and resubmit the command.

---

**CMMVC5823E** The managed disk (MDisk) was not deleted from the MDisk group because the MDisk is part of another MDisk group.

**Explanation:** The managed disk (MDisk) was not

deleted from the storage pool because the MDisk is part of another storage pool.

**User response:** Not applicable.

---

**CMMVC5824E** The managed disk (MDisk) was not deleted from the MDisk group because it does not belong to the MDisk group.

**Explanation:** The managed disk (MDisk) was not deleted from the storage pool because it does not belong to the storage pool.

**User response:** Not applicable.

---

**CMMVC5825E** The managed disk (MDisk) was not deleted from the MDisk group because a virtual disk (VDisk) is allocated from one or more of the specified MDisks. A forced deletion is required.

**Explanation:** The managed disk (MDisk) was not deleted from the storage pool because a volume is allocated from one or more of the specified MDisks.

**User response:** Specify the `-force` option, and resubmit the command.

---

**CMMVC5826E** The virtual disk (VDisk) was not created because an entity that was specified in the command does not exist.

**Explanation:** The volume was not created because an entity that was specified in the command does not exist.

**User response:** Specify a different entity, and resubmit the command.

---

**CMMVC5827E** The command failed as a result of either an inconsistency between two or more of the entered parameters, or an inconsistency between a parameter and the requested action.

**Explanation:** The command failed as a result of an inconsistency between two or more of the entered parameters.

**User response:** Specify one parameter, and resubmit the command.

---

**CMMVC5828E** The virtual disk (VDisk) was not created because the I/O group contains no nodes.

**Explanation:** The volume was not created because the I/O group contains no nodes.

**User response:** Not applicable.

---

**CMMVC5829E** The image-mode or sequential-mode virtual disk (VDisk) was not created because more than one managed disk (MDisk) is specified.

**Explanation:** The image-mode or sequential-mode volume was not created because more than one MDisk is specified.

**User response:** Specify a different MDisk, and resubmit the command.

---

**CMMVC5830E** The image-mode virtual disk (VDisk) was not created because no managed disk (MDisk) was specified in the command.

**Explanation:** The image-mode volume was not created because no managed disk (MDisk) was specified in the command.

**User response:** Specify a MDisk, and resubmit the command.

---

**CMMVC5831E** The virtual disk (VDisk) was not created because the preferred node for I/O operations is not part of the I/O group.

**Explanation:** The volume was not created because the preferred node for I/O operations is not part of the I/O group.

**User response:** Specify a different node, and resubmit the command.

---

**CMMVC5832E** The property of the virtual disk (VDisk) was not modified because an entity that was specified in the command does not exist.

**Explanation:** The property of the volume was not modified because an entity that was specified in the command does not exist.

**User response:** Specify a different entity, and resubmit the command.

---

**CMMVC5833E** The property of the virtual disk (VDisk) was not modified because there are no nodes in the I/O group.

**Explanation:** The property of the volume was not modified because there are no nodes in the I/O group.

**User response:** Not applicable.

---

**CMMVC5834E** The I/O group for the virtual disk (VDisk) was not modified because the group is a recovery I/O group. To modify the I/O group, use the force option.

**Explanation:** The I/O group for the volume was not modified because the group is a recovery I/O group.

**User response:** Specify the -force option, and resubmit the command.

---

**CMMVC5835E** The virtual disk (VDisk) was not expanded because an entity that was specified in the command does not exist.

**Explanation:** The volume was not expanded because an entity that was specified in the command does not exist.

**User response:** Specify a different entity, and resubmit the command.

---

**CMMVC5836E** The virtual disk (VDisk) was not shrunk because it is locked.

**Explanation:** Commands might still be running in the background.

**User response:** Wait for all commands to complete. Use the `lsmigrate` command to view any migrates running in the background.

---

**CMMVC5837E** The action failed because the virtual disk (VDisk) is part of a FlashCopy mapping.

**Explanation:** The action failed because the volume is part of a FlashCopy mapping.

**User response:** Specify a different volume that is not part of a FlashCopy mapping, and resubmit the command.

---

**CMMVC5838E** The action failed because the virtual disk (VDisk) is part of a Remote Copy mapping.

**Explanation:** The action failed because the volume is part of a Remote Copy mapping.

**User response:** Specify a different volume that is not part of a Remote Copy mapping, and resubmit the command.

---

**CMMVC5839E** The virtual disk (VDisk) was not shrunk because an object that was specified in the command does not exist.

**Explanation:** The volume was not shrunk because an object that was specified in the command does not exist.

**User response:** Specify a different object, and resubmit the command.

---

---

**CMMVC5840E** The virtual disk (VDisk) was not deleted because it is mapped to a host or because it is part of a FlashCopy or Remote Copy mapping, or is involved in an image mode migrate.

**Explanation:** The volume was not deleted because it is mapped to a host or because it is part of a FlashCopy or Metro Mirror mapping.

**User response:** Specify a different volume, and resubmit the command.

---

**CMMVC5841E** The virtual disk (VDisk) was not deleted because it does not exist.

**Explanation:** The volume was not deleted because it does not exist.

**User response:** Specify a different volume, and resubmit the command.

---

**CMMVC5842E** The action failed because an object that was specified in the command does not exist.

**Explanation:** The action failed because an entity that was specified in the command does not exist.

**User response:** Specify a different entity, and resubmit the command.

---

**CMMVC5843E** The VDisk-to-host mapping was not created because the VDisk does not have a capacity greater than zero bytes.

**Explanation:** The host map was not created because the volume does not have a capacity greater than zero bytes.

**User response:** Specify a volume in which its capacity is greater than zero bytes, and resubmit the command.

---

**CMMVC5844E** The VDisk-to-host mapping was not created because the SCSI logical unit number (LUN) ID is not valid.

**Explanation:** The host map was not created because the SCSI logical unit number (LUN) ID is not valid.

**User response:** Specify the correct SCSI logical unit number (LUN) ID, and resubmit the command.

---

**CMMVC5845E** The extent was not migrated because an object that was specified in the command does not exist.

**Explanation:** The extent was not migrated because an object that was specified in the command does not exist.

**User response:** Specify a different object, and resubmit the command.

---

**CMMVC5846E** The virtual disk (VDisk) was not migrated because an object that was specified in the command does not exist.

**Explanation:** The volume was not migrated because an object that was specified in the command does not exist.

**User response:** Specify a different object, and resubmit the command.

---

**CMMVC5847E** The virtual disk (VDisk) was not migrated because its associated managed disk (MDisk) is already in the MDisk group.

**Explanation:** The volume was not migrated because its associated managed disk (MDisk) is already in the storage pool.

**User response:** Not applicable.

---

**CMMVC5848E** The action failed because the virtual disk (VDisk) does not exist or it is being deleted.

**Explanation:** The action failed because the volume does not exist or it is being deleted.

**User response:** Specify a different volume, and resubmit the command.

---

**CMMVC5849E** The migration failed because some or all of the extents are already being migrated.

**Explanation:** The migration failed because some or all of the extents are already being migrated.

**User response:** Not applicable.

---

**CMMVC5850E** The extent was not migrated because there is a problem with the source extents.

**Explanation:** The extent was not migrated because there is a problem with the source extents.

**User response:** Not applicable.

---

**CMMVC5851E** The extent was not migrated because there is a problem with the target extents.

**Explanation:** The extent was not migrated because there is a problem with the target extents.

**User response:** Not applicable.

---

**CMMVC5852E** The migration failed because there are too many migrations in progress.

**Explanation:** The migration failed because there are too many migrations in progress.

**User response:** Wait for the migration process to complete, and resubmit the command.

---

**CMMVC5853E** The action failed because there was a problem with the group.

**Explanation:** An attempt was made to work on a volume which is using a storage pool with one of the following problems:

- The target and source storage pools have different extent sizes (group migrate).
- The target and source storage pools are the same (group migrate).
- The target and source storage pools are different (extents migrate).
- The target group (group migrate) is not valid.
- The source group (group migrate) is not valid.

**User response:** Ensure that none of the above conditions exist before reissuing the command.

---

**CMMVC5854E** The extent information was not returned because the extent is not used or does not exist.

**Explanation:** The extent information was not returned because the extent is not used or does not exist.

**User response:** Specify the correct extent, and resubmit the command.

---

**CMMVC5855E** The extent information was not returned because the managed disk (MDisk) is not used by any virtual disk (VDisk).

**Explanation:** The extent information was not returned because the managed disk (MDisk) is not used by any volume.

**User response:** Specify the correct MDisk, and resubmit the command.

---

**CMMVC5856E** The action failed because the virtual disk (VDisk) does not belong to the specified managed disk group.

**Explanation:** The action failed because the volume does not belong to the specified storage pool.

**User response:** Specify a different volume, and resubmit the command.

---

**CMMVC5857E** The action failed because the managed disk (MDisk) does not exist or it is not a member of the managed disk group.

**Explanation:** The action failed because the managed disk (MDisk) does not exist or it is not a member of the storage pool.

**User response:** Specify a different MDisk, and resubmit the command.

---

**CMMVC5858E** The action failed because the virtual disk (VDisk) is in the wrong mode, the managed disk (MDisk) is in the wrong mode, or both are in the wrong mode.

**Explanation:** The action failed because the volume is in the wrong mode, the managed disk (MDisk) is in the wrong mode, or both are in the wrong mode.

**User response:** Check that the volume and MDisk are in the correct mode, and resubmit the command.

---

**CMMVC5859E** The migration did not complete because an error occurred during the migration of the last extent on an image-mode virtual disk (VDisk).

**Explanation:** The migration did not complete because an error occurred during the migration of the last extent on an image-mode volume.

**User response:** Not applicable.

---

**CMMVC5860E** The action failed because there were not enough extents in the managed disk group.

**Explanation:** This error is also returned if a stripe set of MDisks has been specified and one or more of these MDisks does not contain enough free extents to complete the creation of the volume.

**User response:** In this case, the storage pool reports that it has enough free capacity to create the volume. You can check the free capacity on each MDisk by submitting the command **lsfreeextents <mdiskname/ID>**. Alternatively, do not specify a stripe set and let the system choose the free extents automatically.

---

**CMMVC5861E** The action failed because there were not enough extents on the managed disk (MDisk).

**Explanation:** The action failed because there were not enough extents on the managed disk (MDisk).

**User response:** Specify another extent, and resubmit the command.

---

---

**CMMVC5862E** The action failed because the virtual disk (VDisk) is being formatted.

**Explanation:** The action failed because the volume is being formatted.

**User response:** Wait for the volume to be successfully formatted, and resubmit the command.

---

**CMMVC5863E** The migration failed because there are not enough free extents on the target managed disk (MDisk).

**Explanation:** The migration failed because there are not enough free extents on the target managed disk (MDisk).

**User response:** Specify another free extent, and resubmit the command.

---

**CMMVC5864E** The extent information was not returned because the source extent is not used.

**Explanation:** The extent information was not returned because the source extent is not used.

**User response:** Specify a different source extent, and resubmit the command.

---

**CMMVC5865E** The action failed because the extent is out of range for the managed disk (MDisk) or virtual disk (VDisk) specified.

**Explanation:** The extent information was not returned because the extent is out of range for the managed disk (MDisk) or volume.

**User response:** Specify a different extent which is in range for the MDisk or volume and resubmit the command.

---

**CMMVC5866E** The action failed because the extent contains internal data.

**Explanation:** The extent was not migrated because the extent contains internal data.

**User response:** Not applicable.

---

**CMMVC5867E** The action failed because the worldwide port name is already assigned or is not valid.

**Explanation:** The action failed because the worldwide port name is already assigned or is not valid.

**User response:** Specify a different worldwide port name, and resubmit the command.

---

---

**CMMVC5868E** The action failed because an entity that was specified in the command does not exist.

**Explanation:** The action failed because an entity that was specified in the command does not exist.

**User response:** Specify a different entity, and resubmit the command.

---

**CMMVC5869E** The host object was not renamed because the host ID or name is not valid.

**Explanation:** The host object was not renamed because the host ID or name is not valid.

**User response:** Specify a different host ID or name, and resubmit the command.

---

**CMMVC5870E** The host object was not deleted because an entity that was specified in the command does not exist.

**Explanation:** The host object was not deleted because an entity that was specified in the command does not exist.

**User response:** Specify the correct entity, and resubmit the command.

---

**CMMVC5871E** The action failed because one or more of the configured port names is in a mapping.

**Explanation:** The action failed because one or more of the configured port names is in a mapping.

**User response:** Specify a port name that is not in a mapping, and resubmit the command.

---

**CMMVC5872E** The port (WWPN) was not added to the host object because an object that was specified in the command does not exist.

**Explanation:** The port (WWPN) was not added to the host object because an object that was specified in the command does not exist.

**User response:** Specify the correct object, and resubmit the command.

---

**CMMVC5873E** No matching WWPN.

**Explanation:** The action failed because there is no matching worldwide port name.

**User response:** Not applicable.

---

---

**CMMVC5874E** The action failed because the host does not exist.

**Explanation:** The action failed because the host does not exist.

**User response:** Specify a different host, and resubmit the command.

---

**CMMVC5875E** The action failed because the virtual disk (VDisk) does not exist.

**Explanation:** The action failed because the volume does not exist.

**User response:** Specify a different volume, and resubmit the command.

---

**CMMVC5876E** The VDisk-to-host mapping was not created because the maximum number of mappings has been reached.

**Explanation:** The host map was not created because the maximum number of mappings has been reached.

**User response:** Not applicable.

---

**CMMVC5877E** The VDisk-to-host mapping was not created because the maximum number of SCSI LUNs has been allocated.

**Explanation:** The host map was not created because the maximum number of SCSI LUNs has been allocated.

**User response:** Not applicable.

---

**CMMVC5878E** The VDisk-to-host mapping was not created because this VDisk is already mapped to this host.

**Explanation:** The host map was not created because this volume is already mapped to this host.

**User response:** Specify a different volume, and resubmit the command.

---

**CMMVC5879E** The VDisk-to-host mapping was not created because a VDisk is already mapped to this host with this SCSI LUN.

**Explanation:** The host map was not created because this SCSI LUN is already assigned to another mapping.

**User response:** Specify a different SCSI LUN, and resubmit the command.

---



---

**CMMVC5880E** The virtual disk was not created because a capacity of zero bytes is not allowed for image mode disks.

**Explanation:** The host map was not created because the volume has a capacity of zero bytes.

**User response:** Specify a different volume, and resubmit the command.

---

**CMMVC5881E** The FlashCopy mapping was not created because an entity that was specified in the command does not exist.

**Explanation:** The FlashCopy mapping was not created because an entity that was specified in the command does not exist.

**User response:** Specify a different entity, and resubmit the command.

---

**CMMVC5882E** The FlashCopy mapping was not created because a mapping for the source or target virtual disk (VDisk) already exists.

**Explanation:** The FlashCopy mapping was not created because a mapping for the source or target volume already exists.

**User response:** Specify a different source or target volume, and resubmit the command.

---

**CMMVC5883E** The FlashCopy mapping was not created because the recovery I/O group is associated with the source or target virtual disk (VDisk).

**Explanation:** The FlashCopy mapping was not created because the recovery I/O group is associated with the source or target volume.

**User response:** Specify a different recovery I/O group, and resubmit the command.

---

**CMMVC5884E** The FlashCopy mapping was not created because the source or target virtual disk (VDisk) cannot be a member of a Remote Copy mapping.

**Explanation:** The FlashCopy mapping was not created because the source or target volume cannot be a member of a Remote Copy mapping.

**User response:** Specify a different source or target volume, and resubmit the command.

---

---

**CMMVC5885E** The FlashCopy mapping was not created because this source or target virtual disk (VDisk) cannot be a member of a FlashCopy mapping.

**Explanation:** The FlashCopy mapping was not created because this source or target volume cannot be a member of a FlashCopy mapping.

**User response:** Specify a different source or target volume, and resubmit the command.

---

**CMMVC5886E** The FlashCopy mapping was not created because the source or target virtual disk (VDisk) is associated with the recovery I/O group.

**Explanation:** The FlashCopy mapping was not created because the source or target volume is associated with the recovery I/O group.

**User response:** Specify a different source or target volume, and resubmit the command.

---

**CMMVC5887E** The FlashCopy mapping was not created because the source or target virtual disk (VDisk) must not be in router mode.

**Explanation:** The FlashCopy mapping was not created because the source or target volume must not be in router mode.

**User response:** Specify a different source or target volume, and resubmit the command.

---

**CMMVC5888E** The action failed because an entity that was specified in the command does not exist.

**Explanation:** The action failed because an entity that was specified in the command does not exist.

**User response:** Specify the correct entity, and resubmit the command.

---

**CMMVC5889E** The FlashCopy mapping was not deleted because an entity that was specified in the command does not exist.

**Explanation:** The FlashCopy mapping was not deleted because an entity that was specified in the command does not exist.

**User response:** Specify a different entity, and resubmit the command.

---

---

**CMMVC5890E** The FlashCopy mapping or consistency group was not started because starting consistency group 0 is not a valid operation.

**Explanation:** The FlashCopy mapping or consistency group was not started because starting consistency group 0 is not a valid operation.

**User response:** Not applicable.

---

**CMMVC5891E** The FlashCopy consistency group was not created because the name is not valid.

**Explanation:** The FlashCopy consistency group was not created because the name is not valid.

**User response:** Specify a different name, and resubmit the command.

---

**CMMVC5892E** The FlashCopy consistency group was not created because it already exists.

**Explanation:** The FlashCopy consistency group was not created because it already exists.

**User response:** Not applicable.

---

**CMMVC5893E** The action failed because an entity that was specified in the command does not exist.

**Explanation:** The action failed because an entity that was specified in the command does not exist.

**User response:** Specify the correct entity, and resubmit the command.

---

**CMMVC5894E** The FlashCopy consistency group was not deleted because you are trying to delete consistency group 0 or the name of the consistency group is not valid.

**Explanation:** The FlashCopy consistency group was not deleted because the name of the consistency group is not valid or you are trying to delete consistency group 0.

**User response:** Specify the correct consistency group, and resubmit the command.

---

**CMMVC5895E** The FlashCopy consistency group was not deleted because it contains mappings. To delete this consistency group, a forced deletion is required.

**Explanation:** The FlashCopy consistency group was not deleted because it contains mappings.

---



**User response:** Specify that -force option to delete the consistency group.

---

**CMMVC5896E** The FlashCopy mapping was not deleted because the mapping or consistency group is in the preparing state. The mapping or consistency group must be stopped first.

**Explanation:** The FlashCopy mapping was not deleted because the mapping or consistency group is in the preparing state. The mapping or consistency group must be stopped first.

**User response:** Stop the consistency group, and resubmit the command.

---

**CMMVC5897E** The FlashCopy mapping was not deleted because the mapping or consistency group is in the prepared state. The mapping or consistency group must be stopped first.

**Explanation:** The FlashCopy mapping was not deleted because the mapping or consistency group is in the prepared state. The mapping or consistency group must be stopped first.

**User response:** Stop the consistency group, and resubmit the command.

---

**CMMVC5898E** The FlashCopy mapping was not deleted because the mapping or consistency group is in the copying state. The mapping or consistency group must be stopped first.

**Explanation:** The FlashCopy mapping was not deleted because the mapping or consistency group is in the copying state. The mapping or consistency group must be stopped first.

**User response:** Stop the consistency group, and resubmit the command.

---

**CMMVC5899E** The FlashCopy mapping was not deleted because the mapping or consistency group is in the stopped state. To delete the mapping, a forced deletion is required.

**Explanation:** The FlashCopy mapping was not deleted because the mapping or consistency group is in the stopped state.

**User response:** Specify the -force option to delete the mapping.

---

**CMMVC5900E** The FlashCopy mapping was not deleted because the mapping or consistency group is in the suspended state. The mapping or consistency group must be stopped first.

**Explanation:** The FlashCopy mapping was not deleted because the mapping or consistency group is in the suspended state. The mapping or consistency group must be stopped first.

**User response:** Stop the consistency group, and resubmit the command.

---

**CMMVC5901E** The FlashCopy mapping was not prepared because the mapping or consistency group is already in the preparing state.

**Explanation:** The FlashCopy mapping was not prepared because the mapping or consistency group is already in the preparing state.

**User response:** Not applicable.

---

**CMMVC5902E** The FlashCopy mapping was not prepared because the mapping or consistency group is already in the prepared state.

**Explanation:** The FlashCopy mapping was not prepared because the mapping or consistency group is already in the prepared state.

**User response:** Not applicable.

---

**CMMVC5903E** The FlashCopy mapping was not prepared because the mapping or consistency group is already in the copying state.

**Explanation:** The FlashCopy mapping was not prepared because the mapping or consistency group is already in the copying state.

**User response:** Not applicable.

---

**CMMVC5904E** The FlashCopy mapping was not prepared because the mapping or consistency group is already in the suspended state.

**Explanation:** The FlashCopy mapping was not prepared because the mapping or consistency group is already in the suspended state.

**User response:** Not applicable.

---

**CMMVC5905E** The FlashCopy mapping or consistency group was not started because the mapping or consistency group is in the idle state. The mapping or consistency group must be prepared first.

**Explanation:** The FlashCopy mapping or consistency group was not started because the mapping or consistency group is in the idle state.

**User response:** Prepare the mapping or consistency group, and resubmit the command.

---

**CMMVC5906E** The FlashCopy mapping or consistency group was not started because the mapping or consistency group is in the preparing state.

**Explanation:** The FlashCopy mapping or consistency group was not started because the mapping or consistency group is in the preparing state.

**User response:** Not applicable.

---

**CMMVC5907E** The FlashCopy mapping or consistency group was not started because the mapping or consistency group is already in the copying state.

**Explanation:** The FlashCopy mapping or consistency group was not started because the mapping or consistency group is already in the copying state.

**User response:** Not applicable.

---

**CMMVC5908E** The FlashCopy mapping or consistency group was not started because the mapping or consistency group is in the stopped state. The mapping or consistency group must be prepared first.

**Explanation:** The FlashCopy mapping or consistency group was not started because the mapping or consistency group is in the stopped state.

**User response:** Prepare the mapping or consistency group, and resubmit the command.

---

**CMMVC5909E** The FlashCopy mapping or consistency group was not started because the mapping or consistency group is in the suspended state.

**Explanation:** The FlashCopy mapping or consistency group was not started because the mapping or consistency group is in the suspended state.

**User response:** Not applicable.

---

**CMMVC5910E** The FlashCopy mapping or consistency group was not stopped because the mapping or consistency group is in the idle state.

**Explanation:** The FlashCopy mapping or consistency group was not stopped because the mapping or consistency group is in the idle state.

**User response:** Not applicable.

---

**CMMVC5911E** The FlashCopy mapping or consistency group was not stopped because the mapping or consistency group is in the preparing state.

**Explanation:** The FlashCopy mapping or consistency group was not stopped because the mapping or consistency group is in the preparing state.

**User response:** Not applicable.

---

**CMMVC5912E** The FlashCopy mapping or consistency group was not stopped because the mapping or consistency group is already in the stopped state.

**Explanation:** The FlashCopy mapping or consistency group was not stopped because the mapping or consistency group is already in the stopped state.

**User response:** Not applicable.

---

**CMMVC5913E** The properties of the FlashCopy mapping were not modified because the mapping or consistency group is in the preparing state.

**Explanation:** The properties of the FlashCopy mapping were not modified because the mapping or consistency group is in the preparing state.

**User response:** Not applicable.

---

**CMMVC5914E** The properties of the FlashCopy mapping were not modified because the mapping or consistency group is in the prepared state.

**Explanation:** The properties of the FlashCopy mapping were not modified because the mapping or consistency group is in the prepared state.

**User response:** Not applicable.

---

**CMMVC5915E** The properties of the FlashCopy mapping were not modified because the mapping or consistency group is in the copying state.

**Explanation:** The properties of the FlashCopy mapping were not modified because the mapping or consistency group is in the copying state.

**User response:** Not applicable.

---

**CMMVC5916E** The properties of the FlashCopy mapping were not modified because the mapping or consistency group is in the suspended state.

**Explanation:** The properties of the FlashCopy mapping were not modified because the mapping or consistency group is in the suspended state.

**User response:** Not applicable.

---

**CMMVC5917E** The FlashCopy mapping was not created because there is no memory in which to create the bitmap.

**Explanation:** The FlashCopy mapping was not created because there is no memory to create the bitmap.

**User response:** Not applicable.

---

**CMMVC5918E** The FlashCopy mapping was not prepared, either because there are no online nodes in the I/O group or because there are unrecovered FlashCopy mappings or unrecovered Global Mirror or Metro Mirror relationships in the I/O group.

**Explanation:** This error might be caused by a temporary loss of all of the nodes in the I/O group, which causes all of the FlashCopy mappings and Global and Metro Mirror relationships of the I/O group to be unusable.

**User response:** Perform the following steps:

1. Ensure that at least one of the nodes in the I/O group of the mapping is online.
2. Fix all of the unfixed events in the event log.
3. Follow the fix procedures.

You might be required to delete and re-add ALL of the FlashCopy maps and Global and Metro Mirror relationships in the I/O group.

Resubmit the command.

---

**CMMVC5919E** The FlashCopy mapping or consistency group was not started, either because there are no online nodes in the I/O group or because there are unrecovered FlashCopy mappings or unrecovered Global Mirror or Metro Mirror relationships in the I/O group.

**Explanation:** This error might be caused by a temporary loss of all of the nodes in the I/O group, which causes all of the FlashCopy mappings and Global and Metro Mirror relationships of the I/O group to be unusable.

**User response:** Perform the following steps:

1. Ensure that at least one of the nodes in the I/O group of the mapping is online.
2. Fix all of the unfixed events in the event log.
3. Follow the fix procedures.

You might be required to delete and re-add ALL of the FlashCopy maps and Global and Metro Mirror relationships in the I/O group.

Resubmit the command.

---

**CMMVC5920E** The FlashCopy mapping was not created because the consistency group is not idle.

**Explanation:** The FlashCopy mapping was not created because the consistency group is not idle.

**User response:** Not applicable.

---

**CMMVC5921E** The properties of the FlashCopy mapping were not modified because the consistency group is not idle.

**Explanation:** The properties of the FlashCopy mapping were not modified because the consistency group is not idle.

**User response:** Not applicable.

---

**CMMVC5922E** The FlashCopy mapping was not created because the destination virtual disk (VDisk) is too small.

**Explanation:** The FlashCopy mapping was not created because the destination volume is too small.

**User response:** Specify a different volume, and resubmit the command.

---

**CMMVC5923E** The FlashCopy mapping cannot be created, either because there are no online nodes in the I/O group or because there are unrecovered FlashCopy mappings or unrecovered Global Mirror or Metro Mirror relationships in the I/O group.

**Explanation:** This error might be caused by a temporary loss of all of the nodes in the I/O group, which causes all of the FlashCopy mappings and Global and Metro Mirror relationships of the I/O group to be unusable.

**User response:** Perform the following steps:

1. Ensure that at least one of the nodes in the I/O group of the mapping is online.
2. Fix all of the unfixed events in the event log.
3. Follow the fix procedures.

## CMMVC5924E • CMMVC5935E

You might be required to delete and re-add ALL of the FlashCopy maps and Global and Metro Mirror relationships in the I/O group.

Resubmit the command.

---

**CMMVC5924E** The FlashCopy mapping was not created because the source and target virtual disks (VDisks) are different sizes.

**Explanation:** The FlashCopy mapping was not created because the source and target volumes are different sizes.

**User response:** Specify a different source and target volume that are the same size, and resubmit the command.

---

**CMMVC5925E** The remote cluster partnership was not created because it already exists.

**Explanation:** The remote cluster partnership was not created because it already exists.

**User response:** Specify a different remote cluster partnership, and resubmit the command.

---

**CMMVC5926E** The remote cluster partnership was not created because there are too many partnerships.

**Explanation:** The remote cluster partnership was not created because there are too many partnerships.

**User response:** Not applicable.

---

**CMMVC5927E** The action failed because the cluster ID is not valid.

**Explanation:** The action failed because the cluster ID is not valid.

**User response:** Specify the correct cluster ID, and resubmit the command.

---

**CMMVC5928E** The action failed because the cluster name is a duplicate of another cluster.

**Explanation:** The action failed because the cluster name is a duplicate of another cluster.

**User response:** Specify a different cluster name, and resubmit the command.

---

**CMMVC5929E** The Remote Copy partnership was not deleted because it has already been deleted.

**Explanation:** The Remote Copy partnership was not deleted because it has already been deleted.

**User response:** Not applicable.

---

**CMMVC5930E** The Remote Copy relationship was not created because an object that was specified in the command does not exist.

**Explanation:** The Remote Copy relationship was not created because an object that was specified in the command does not exist.

**User response:** Specify the correct object, and resubmit the command.

---

**CMMVC5931E** The Remote Copy relationship was not created because the master or auxiliary virtual disk (VDisk) is locked.

**Explanation:** The Remote Copy relationship was not created because the master or auxiliary volume is locked.

**User response:** Unlock the master or auxiliary volume, and resubmit the command.

---

**CMMVC5932E** The Remote Copy relationship was not created because the master or auxiliary virtual disk (VDisk) is a member of a FlashCopy mapping.

**Explanation:** The Remote Copy relationship was not created because the master or auxiliary volume is a member of a FlashCopy mapping, and the partner cluster is running a downlevel software version.

**User response:** Not applicable.

---

**CMMVC5933E** The Remote Copy relationship was not created because the master or auxiliary virtual disk (VDisk) is in the recovery I/O group.

**Explanation:** The Remote Copy relationship was not created because the master or auxiliary volume is in the recovery I/O group.

**User response:** Not applicable.

---

**CMMVC5934E** The Remote Copy relationship was not created because the master or auxiliary virtual disk (VDisk) is in the router mode.

**Explanation:** The Remote Copy relationship was not created because the master or auxiliary volume is in the router mode.

**User response:** Not applicable.

---

**CMMVC5935E** The action failed because an object that was specified in the command does not exist.

**Explanation:** The action failed because an object that was specified in the command does not exist.

**User response:** Specify the correct object, and resubmit the command.

---

**CMMVC5936E** The action failed because an object that was specified in the command does not exist.

**Explanation:** The action failed because an object that was specified in the command does not exist.

**User response:** Specify the correct object, and resubmit the command.

---

**CMMVC5937E** The action failed because an object that was specified in the command does not exist.

**Explanation:** The action failed because an object that was specified in the command does not exist.

**User response:** Specify the correct object, and resubmit the command.

---

**CMMVC5938E** The Remote Copy consistency group was not deleted because the consistency group contains relationships. To delete the consistency group, the force option is required.

**Explanation:** Remote Copy consistency group was not deleted because the consistency group contains relationships.

**User response:** Specify the -force option to delete the consistency group.

---

**CMMVC5939E** The action failed because the cluster is not in a stable state.

**Explanation:** The action failed because the cluster is not in a stable state.

**User response:** Not applicable.

---

**CMMVC5940E** The cluster that contains the auxiliary virtual disk (VDisk) is unknown.

**Explanation:** The cluster that contains the auxiliary volume is unknown.

**User response:** Not applicable.

---

**CMMVC5941E** The cluster that contains the master virtual disk (VDisk) has too many consistency groups.

**Explanation:** The cluster that contains the master volume has too many consistency groups.

**User response:** Not applicable.

---

**CMMVC5942E** The cluster that contains the auxiliary virtual disk (VDisk) has too many consistency groups.

**Explanation:** The cluster that contains the auxiliary volume has too many consistency groups.

**User response:** Not applicable.

---

**CMMVC5943E** The specified relationship is not valid.

**Explanation:** The specified relationship is not valid.

**User response:** Specify the correct relationship, and resubmit the command.

---

**CMMVC5944E** The specified consistency group is not valid.

**Explanation:** The specified consistency group is not valid.

**User response:** Specify the correct consistency group, and resubmit the command.

---

**CMMVC5945E** The specified master cluster is not valid.

**Explanation:** The specified master cluster is not valid.

**User response:** Specify the correct master cluster, and resubmit the command.

---

**CMMVC5946E** The specified auxiliary cluster is not valid.

**Explanation:** The specified auxiliary cluster is not valid.

**User response:** Specify the correct auxiliary cluster, and resubmit the command.

---

**CMMVC5947E** The specified master virtual disk (VDisk) is not valid.

**Explanation:** The specified master volume is not valid.

**User response:** Specify the correct master volume, and resubmit the command.

---

**CMMVC5948E** The specified auxiliary virtual disk (VDisk) is not valid.

**Explanation:** The specified auxiliary volume is not valid.

**User response:** Specify the auxiliary volume, and resubmit the command.

---

**CMMVC5949E** The specified relationship is unknown.

**Explanation:** The specified relationship is unknown.

**User response:** Specify a different relationship, and resubmit the command.

---

**CMMVC5950E** The specified consistency group is unknown.

**Explanation:** The specified consistency group is unknown.

**User response:** Specify a different consistency group, and resubmit the command.

---

**CMMVC5951E** The operation cannot be performed because the relationship is not a stand-alone relationship.

**Explanation:** The operation cannot be performed because the relationship is not a stand-alone one.

**User response:** Not applicable.

---

**CMMVC5952E** The relationship and consistency group have different master clusters.

**Explanation:** The relationship and consistency group have different master clusters.

**User response:** Not applicable.

---

**CMMVC5953E** The relationship and group have different auxiliary clusters.

**Explanation:** The relationship and group have different auxiliary clusters.

**User response:** Not applicable.

---

**CMMVC5954E** The master and auxiliary virtual disks (VDisks) are different sizes.

**Explanation:** The master and auxiliary volumes are different sizes.

**User response:** Not applicable.

---

**CMMVC5955E** The maximum number of relationships has been reached.

**Explanation:** The maximum number of relationships has been reached.

**User response:** Not applicable.

---

**CMMVC5956E** The maximum number of consistency groups has been reached.

**Explanation:** The maximum number of consistency groups has been reached.

**User response:** Not applicable.

---

**CMMVC5957E** The master virtual disk (VDisk) is already in a relationship.

**Explanation:** The master volume is already in a relationship.

**User response:** Specify a different master volume, and resubmit the command.

---

**CMMVC5958E** The auxiliary virtual disk (VDisk) is already in a relationship.

**Explanation:** The auxiliary volume is already in a relationship.

**User response:** Specify a different auxiliary volume, and resubmit the command.

---

**CMMVC5959E** There is a relationship that already has this name on the master cluster.

**Explanation:** There is a relationship that already has this name on the master cluster.

**User response:** Specify a different name, and resubmit the command.

---

**CMMVC5960E** There is a relationship that already has this name on the auxiliary cluster.

**Explanation:** There is a relationship that already has this name on the auxiliary cluster.

**User response:** Specify a different name, and resubmit the command.

---

**CMMVC5961E** There is a consistency group that already has this name on the master cluster.

**Explanation:** There is a consistency group that already has this name on the master cluster.

**User response:** Specify a different name, and resubmit the command.

---

**CMMVC5962E** There is a consistency group that already has this name on the auxiliary cluster.

**Explanation:** There is a consistency group that already has this name on the auxiliary cluster.

**User response:** Specify a different name, and resubmit the command.

---

**CMMVC5963E No direction has been defined.**

**Explanation:** No direction has been defined.

**User response:** Not applicable.

---

**CMMVC5964E The copy priority is not valid.**

**Explanation:** The copy priority is not valid.

**User response:** Not applicable.

---

**CMMVC5965E The virtual disks (VDisks) are in different I/O groups on the local cluster.**

**Explanation:** The volumes are in different I/O groups on the local cluster.

**User response:** Not applicable.

---

**CMMVC5966E The master virtual disk (VDisk) is unknown.**

**Explanation:** The master volume is unknown.

**User response:** Specify a different master volume, and resubmit the command.

---

**CMMVC5967E The auxiliary virtual disk (VDisk) is unknown.**

**Explanation:** The auxiliary volume is unknown.

**User response:** Specify a different auxiliary volume, and resubmit the command.

---

**CMMVC5968E The relationship cannot be added because the states of the relationship and the consistency group do not match.**

**Explanation:** The relationship cannot be added because the states of the relationship and the consistency group do not match.

**User response:** Not applicable.

---

**CMMVC5969E The Remote Copy relationship was not created, either because there are no online nodes in the I/O group or because there are unrecovered FlashCopy mappings or unrecovered Global Mirror or Metro Mirror relationships in the I/O group.**

**Explanation:** This error might be caused by a temporary loss of all of the nodes in the I/O group, which causes all of the FlashCopy mappings and Global and Metro Mirror relationships of the I/O group to be unusable.

**User response:** Perform the following steps:

1. Ensure that at least one of the nodes in the I/O group is online.

2. Fix all of the unfixed events in the event log.
3. Follow the fix procedures.

You might be required to delete and re-add ALL of the FlashCopy maps and Global and Metro Mirror relationships in the I/O group.

Resubmit the command.

---

**CMMVC5970E The Remote Copy relationship was not created because there is not enough memory.**

**Explanation:** The Remote Copy relationship was not created because there is not enough memory.

**User response:** Not applicable.

---

**CMMVC5971E The operation was not performed because the consistency group contains no relationships.**

**Explanation:** The operation was not performed because the consistency group contains no relationships.

**User response:** Not applicable.

---

**CMMVC5972E The operation was not performed because the consistency group contains relationships.**

**Explanation:** The operation was not performed because the consistency group contains relationships.

**User response:** Not applicable.

---

**CMMVC5973E The operation was not performed because the consistency group is not synchronized.**

**Explanation:** The operation was not performed because the consistency group is not synchronized.

**User response:** Specify the Force option when starting the consistency group.

---

**CMMVC5974E The operation was not performed because the consistency group is offline.**

**Explanation:** The operation was not performed because the consistency group is offline.

**User response:** Not applicable.

---

**CMMVC5975E The operation was not performed because the cluster partnership is not connected.**

**Explanation:** The operation was not performed because the cluster partnership is not connected.

**User response:** Not applicable.

---

**CMMVC5976E** The operation was not performed because the consistency group is in the freezing state.

**Explanation:** The operation was not performed because the consistency group is in the freezing state.

**User response:** Not applicable.

---

**CMMVC5977E** The operation was not performed because it is not valid given the current consistency group state.

**Explanation:** The operation was not performed because it is not valid given the current consistency group state.

**User response:** Not applicable.

---

**CMMVC5978E** The operation was not performed because the relationship is consistent but is not synchronized. Restarting the relationship by using the `-force` parameter will make the relationship inconsistent until the background copy has completed.

**Explanation:** Input transactions have occurred on either the primary or secondary volumes since the ConsistentStopped or Idling state has occurred. Because the relationship is no longer synchronized, the state of the relationship is now Stopped.

The `-force` parameter of the `startcrrelationship` command is required when the relationship is not synchronized because consistency would be lost by starting the copy operation. Submitting the `startcrrelationship` command on an unsynchronized relationship without using the `-force` parameter is not supported.

If a relationship is in the InconsistentStopped, InconsistentCopying or ConsistentSynchronized state, the `-force` parameter is not required, but is supported.

**User response:** Consider using the `-force` parameter of the `startcrrelationship` command, if appropriate.

---

**CMMVC5980E** The operation was not performed because the master and auxiliary clusters are not connected.

**Explanation:** The operation was not performed because the master and auxiliary clusters are not connected.

**User response:** Not applicable.

---

**CMMVC5981E** The operation was not performed because the relationship is in the freezing state.

**Explanation:** The operation was not performed

because the relationship is in the freezing state.

**User response:** Not applicable.

---

**CMMVC5982E** The operation was not performed because it is not valid given the current relationship state.

**Explanation:** The operation was not performed because it is not valid given the current relationship state.

**User response:** Not applicable.

---

**CMMVC5983E** dump file was not created. This may be due to the file system being full.

**Explanation:** dump file was not created. This may be due to the file system being full.

**User response:** Not applicable.

---

**CMMVC5984E** The dump file was not written to disk. This may be due to the file system being full.

**Explanation:** The dump file was not written to disk. This may be due to the file system being full.

**User response:** Not applicable.

---

**CMMVC5985E** The action failed because the specified directory is not permitted for this command.

**Explanation:** You have attempted to copy, delete, or list dumps from a directory that is not valid. A list of valid directories for these commands is provided in the documentation.

**User response:** Ensure that the directory you specify is valid, and resubmit the command.

---

**CMMVC5986E** The tracing of I/O operations was not started because the virtual disk (VDisk) or managed disk (MDisk) failed to return any statistics.

**Explanation:** The tracing of I/O operations was not started because the volume or managed disk (MDisk) failed to return statistics.

**User response:** Not applicable.

---

**CMMVC5987E** *VALUE* is not a valid command line option.

**Explanation:** The specified string that you have entered is not a supported command line option.

**User response:** Specify a supported option, and resubmit the command.



---

**CMMVC5988E** command should not be run by the root userid. Use the admin userid.

**Explanation:** This command should not be issued if you are logged in with a root user ID. Use the admin userid.

**User response:** Log off of the root user ID and log in as admin.

---

**CMMVC5989E** The operation was not performed because the relationship is offline.

**Explanation:** The operation was not performed because the relationship is offline.

**User response:** Not applicable.

---

**CMMVC5990E** The FlashCopy consistency group was not stopped as there are no FlashCopy mappings within the group.

**Explanation:** The FlashCopy consistency group was not stopped as there are no FlashCopy mappings within the group.

**User response:** Not applicable.

---

**CMMVC5991E** The Remote Copy consistency group was not stopped as there are no Remote Copy relationships within the group.

**Explanation:** The Remote Copy consistency group was not stopped as there are no Remote Copy relationships within the group.

**User response:** Not applicable.

---

**CMMVC5992E** The Remote Copy consistency group was not stopped as there are no Remote Copy relationships within the group.

**Explanation:** The Remote Copy consistency group was not stopped as there are no Remote Copy relationships within the group.

**User response:** Not applicable.

---

**CMMVC5993E** The specified upgrade package does not exist.

**Explanation:** The specified upgrade package does not exist.

**User response:** Not applicable.

---

**CMMVC5994E** Error in verifying the signature of the upgrade package.

**Explanation:** The system could not verify the signature of the upgrade package due to the following reasons:

- There is not enough space on the system to copy the file.
- The package is incomplete or contains errors.

**User response:** If the copy failed with an error indicating that there was insufficient space on the system, free up additional space on your system. Otherwise, ensure that the cluster time and date stamp on the signature is correct. (For example, the time and date cannot be in the future.)

---

**CMMVC5995E** Error in unpacking the upgrade package.

**Explanation:** The most likely cause of this error is lack of system space.

**User response:** Reboot the node and unpack the upgrade package again.

---

**CMMVC5996E** The specific upgrade package cannot be installed over the current version.

**Explanation:** The upgrade package is not compatible with the current version or the system.

**User response:** Check the available upgrade packages and find the correct upgrade package for your current version and for your system. If the upgrade package is correct for your system, check the version requirements for the package. You might have to upgrade the current version to an intermediate version before you upgrade to the latest version. (For example, if your current version is 1 and you are trying to upgrade to version 3, you might need to upgrade to version 2 before applying the version 3 upgrade.)

---

**CMMVC5999W** Featurization for this facility has not been enabled.

**Explanation:** Featurization for this facility has not been enabled.

**User response:** Not applicable.

---

**CMMVC6000W** Featurization for this facility has not been enabled.

**Explanation:** Featurization for this facility has not been enabled.

**User response:** Not applicable.

---

**CMMVC6001E** The FlashCopy consistency group was not started as there are no FlashCopy mappings within the group.

**Explanation:** The FlashCopy consistency group was not started as there are no FlashCopy mappings within the group.

**User response:** Create a FlashCopy within the appropriate group.

---

**CMMVC6002E** This command can only be run on a node that is in the service state.

**Explanation:** This command can only be run on a node that is in the service state.

**User response:** Not applicable.

---

**CMMVC6003E** This command can not be run on a node that is in the service state.

**Explanation:** This command can not be run on a node that is in the service state.

**User response:** Not applicable.

---

**CMMVC6004E** The delimiter value *VALUE* is invalid.

**Explanation:** The specified value is not a valid delimiter value.

**User response:** Specify a different delimiter.

---

**CMMVC6005E** The view request failed as the specified object is not a member of an appropriate group.

**Explanation:** A view was request on an object that has been incorrectly initialized.

**User response:** Ensure that the object is correctly initialized before resubmitting the view request.

---

**CMMVC6006E** The managed disk (MDisk) was not deleted because the resource was busy.

**Explanation:** An attempt was made to delete an MDisk from a storage pool that is being used as a source and destination for migration operations.

**User response:** Ensure that the storage pool is not being used for migration operations before reissuing the command.

---

**CMMVC6007E** The two passwords that were entered do not match.

**Explanation:** The two passwords entered for verification of your password change were not the same.

**User response:** Re-enter the passwords.

---

**CMMVC6008E** The key already exists.

**Explanation:** An attempt was made to load a duplicate SSH key.

**User response:** Not applicable.

---

**CMMVC6009E** Unable to malloc a block of memory in which to copy the returned data.

**Explanation:** The command line was unable to allocate a block of memory in which to copy the results of the query.

**User response:** Resubmit the command. If the problem persists, contact IBM technical support for assistance.

---

**CMMVC6010E** Unable to complete the command as there are insufficient free extents, or the command requested an expansion of 0 size.

**Explanation:** There are not enough free extents to meet the request.

**User response:** Not applicable.

---

**CMMVC6011E** This cluster is part of a remote cluster partnership. Because this upgrade package will make changes to the cluster state, it cannot be applied to the current code level until all remote cluster partnerships are deleted.

**Explanation:** You have attempted to apply software when a Remote Copy relationship to a remote cluster exists.

**User response:** Delete the Remote Copy relationship to the remote clusters, and resubmit the command.

---

**CMMVC6012W** The virtualized storage capacity is approaching the amount that you are licensed to use.

**Explanation:** The requested action has completed. However, the limits permitted by the license you purchased are approaching.

**User response:** Subsequent actions might require that you increase your licensed limits.

---

**CMMVC6013E** The command failed because there is a consistency group mismatch on the aux cluster.

**Explanation:** The action has failed as there was a difference in attributes between the Metro Mirror consistency groups involved.

**User response:** Ensure that the attributes of the two Metro Mirror consistency groups match before resubmitting the command.

---

**CMMVC6014E** The command failed because the requested object is either unavailable or does not exist.

**Explanation:** The command failed because the requested object is either unavailable or does not exist.

**User response:** Ensure that all parameters have been correctly entered. If this is the case the determine why the object is unavailable, then resubmit the command.

---

**CMMVC6015E** A delete request is already in progress for this object.

**Explanation:** A delete request is already in progress for this object.

**User response:** Not applicable.

---

**CMMVC6016E** The action failed as there would be, or are, no more disks in the MDisk group.

**Explanation:** The action failed as there would be, or are, no more disks in the I/O group.

**User response:** Ensure that all parameters have been correctly entered.

---

**CMMVC6017E** A parameter or argument contains invalid characters. Ensure that all characters are ASCII.

**Explanation:** The command-line interface (CLI) will only accept ASCII input.

**User response:** Ensure that all input to the CLI is ASCII, then resubmit the command.

---

**CMMVC6018E** The software upgrade pre-install process failed.

**Explanation:** The software upgrade failed as there was an error during the preprocessing. The package is either not valid or corrupted.

**User response:** Ensure the package is a valid upgrade package. Download the package from the source location again as it might have been corrupted during a network transfer.

---

**CMMVC6019E** The software upgrade failed as a node pended as the upgrade was in progress.

**Explanation:** The software upgrade failed as a node pended as the upgrade was in progress.

**User response:** Ensure that all nodes are online and available before restarting the upgrade process.

---

**CMMVC6020E** The software upgrade failed because the system was unable to distribute the software package to all of the nodes.

**Explanation:** The system could not complete the process of updating files. A full disk is a possible cause.

**User response:** Ensure that all nodes are online, and use the `cleandumps` command to clean the upgrades directory.

---

**CMMVC6021E** The system is currently busy performing another request. Try again later.

**Explanation:** The requested action failed as the system is processing another request.

**User response:** Wait before resubmitting the request.

---

**CMMVC6022E** The system is currently busy performing another request. Try again later.

**Explanation:** The requested action failed as the system is processing another request.

**User response:** Wait before resubmitting the request.

---

**CMMVC6023E** The system is currently busy performing another request. Try again later.

**Explanation:** The requested action failed as the system is processing another request.

**User response:** Wait before resubmitting the request.

---

**CMMVC6024E** The auxiliary VDisk entered is invalid.

**Explanation:** The auxiliary volume is entered as a parameter in the command-line interface is not a valid auxiliary volume.

**User response:** Select a valid auxiliary volume, and resubmit the command.

---

**CMMVC6025E** The RC consistency group Master cluster is not the local cluster.

**Explanation:** The auxiliary volume is entered as a parameter in the command-line interface is not a valid auxiliary volume.

**User response:** Resubmit the command with a consistency group that belongs to the local cluster.

---

---

**CMMVC6026E** The RC consistency group is not in the stopped state.

**Explanation:** The action failed as the Metro Mirror consistency group is not in the stopped state.

**User response:** Ensure that the Metro Mirror consistency group is in the stopped state before resubmitting the command.

---

**CMMVC6027E** The RC consistency group is not the primary master.

**Explanation:** The RC consistency group requested in the command is not the Metro Mirror primary master.

**User response:** Ensure that the parameters have been entered correctly on the command line.

---

**CMMVC6028E** This upgrade package cannot be applied to the current software level because it contains changes to the cluster state and there are remote cluster partnership defined.

**Explanation:** The action failed because there is a connected remote cluster. The upgrade cannot be applied because it would render the remote cluster at a different code level to the remote cluster.

**User response:** Ensure that the cluster partnership is unconfigured before resubmitting the command. Ensure that you unconfigure the remote cluster and upgrade the code on it before reconfiguring the cluster partnership.

---

**CMMVC6029E** All nodes must have identical code level before a concurrent code upgrade can be performed.

**Explanation:** The concurrent upgrade failed as two or more nodes were at differing code levels. All nodes must be at the same code level before a software upgrade can be performed.

**User response:** Use the service assistant to bring all nodes to the same level before resubmitting the concurrent upgrade.

---

**CMMVC6030E** The operation was not performed because the FlashCopy mapping is part of a consistency group. The action must be performed at the consistency group level.

**Explanation:** An attempt was made to stop a FlashCopy mapping. This failed as the FlashCopy mapping is part of a consistency group.

**User response:** Issue the stop command to the FlashCopy consistency group. This will stop all FlashCopies within that group that are in progress.

---

---

**CMMVC6031E** The operation was not performed because the FlashCopy consistency group is empty.

**Explanation:** An attempt was made to prestart an empty FlashCopy consistency group.

**User response:** Not applicable.

---

**CMMVC6032E** The operation was not performed because one or more of the entered parameters is invalid for this operation.

**Explanation:** An parameter that is not valid was entered for the command.

**User response:** If attempting to change the I/O group to which the volume belongs, ensure that the volume is not already a part of the group.

---

**CMMVC6033E** The action failed due to an internal error.

**Explanation:** An internal error caused the action to fail.

**User response:** Not applicable.

---

**CMMVC6034E** The action failed because the maximum number of objects has been reached.

**Explanation:** The action failed because the maximum number of objects has been reached.

**User response:** Not applicable.

---

**CMMVC6035E** The action failed as the object already exists.

**Explanation:** An operation was requested to create an object that already exists.

**User response:** Ensure that the name you are attempting to apply to a new object does not exist, or change the name before re-issuing the command.

---

**CMMVC6036E** An invalid action was requested.

**Explanation:** The action failed because it is not a valid action with the command that was issued.

**User response:** Issue an action that is valid with the command.

---

**CMMVC6037E** The action failed as the object is not empty.

**Explanation:** The action failed because an object was specified.

**User response:** Resubmit the command without specifying an object.

---

---

**CMMVC6038E** The action failed as the object is empty.

**Explanation:** The action failed because an object was not specified.

**User response:** Specify an object, and resubmit the command.

---

**CMMVC6039E** The action failed as the object is not a member of a group.

**Explanation:** The action failed because the object is not a member of a group.

**User response:** Specify an object that is part of a group, and resubmit the command.

---

**CMMVC6040E** The action failed as the object is not a parent.

**Explanation:** The action failed because the object is not a parent object.

**User response:** Specify an object that is a parent, and resubmit the command.

---

**CMMVC6041E** The action failed as the cluster is full.

**Explanation:** The action failed because the cluster is full.

**User response:** Remove data from the cluster, and resubmit the command.

---

**CMMVC6042E** The action failed as the object is not a cluster member.

**Explanation:** The action failed because the object is not a member of the cluster.

**User response:** Specify an object that is a member of the cluster, and resubmit the command.

---

**CMMVC6043E** The action failed as the object is a member of a group.

**Explanation:** The action failed because the object is a member of a group.

**User response:** Specify an object that is not a member of a group, and resubmit the command.

---

**CMMVC6044E** The action failed as the object is a parent.

**Explanation:** The action failed because the object is a parent object.

**User response:** Specify an object that is not a parent object, and resubmit the command.

---

---

**CMMVC6045E** The action failed, as the -force flag was not entered.

**Explanation:** The action failed because the -force option was not entered.

**User response:** Specify the -force option in the command.

---

**CMMVC6046E** The action failed as too many candidates were selected.

**Explanation:** The action failed because too many candidates were specified.

**User response:** Specify fewer candidates in the command.

---

**CMMVC6047E** The action failed as too few candidates were selected.

**Explanation:** An action was requested with too few candidate objects.

**User response:** Determine the correct number of candidates required for the specific command and reissue the command.

---

**CMMVC6048E** The action failed as the object is busy.

**Explanation:** The action failed because the object is busy.

**User response:** Not applicable.

---

**CMMVC6049E** The action failed as the object is not ready.

**Explanation:** The action failed because the object is not ready.

**User response:** Not applicable.

---

**CMMVC6050E** The action failed as the command was busy.

**Explanation:** The action failed because the command is busy.

**User response:** Not applicable.

---

**CMMVC6051E** An unsupported action was selected.

**Explanation:** The action failed because it is not valid with the command.

**User response:** Specify an action that is valid with the command.

---

---

**CMMVC6052E** The action failed as the object is a member of a FlashCopy mapping.

**Explanation:** The object is a member of a FlashCopy mapping, thus it cannot be deleted.

**User response:** Specify an object that is not a member of a FlashCopy mapping, or remove the object from the FlashCopy mapping.

---

**CMMVC6053E** An invalid WWPN was entered.

**Explanation:** A worldwide port name (WWPN) that is not valid was specified.

**User response:** Specify a valid WWPN.

---

**CMMVC6054E** The action failed as not all nodes are online.

**Explanation:** One or more nodes are not online.

**User response:** Check that each node is online, and resubmit the command.

---

**CMMVC6055E** The action failed as an upgrade is in progress.

**Explanation:** The action failed because a software upgrade is in progress.

**User response:** Wait for the software upgrade to complete, and resubmit the command.

---

**CMMVC6056E** The action failed as the object is too small.

**Explanation:** The action failed because the object is too small.

**User response:** Specify a different object, and resubmit the command.

---

**CMMVC6058E** The action failed as the object is in the recovery HWS.

**Explanation:** An attempt was made to perform an operation on a node that is in the recovery I/O group.

**User response:** Get the node into one of the other I/O groups and reissue the command.

---

**CMMVC6059E** The action failed as the object is in an invalid mode.

**Explanation:** The action failed because the object is in the wrong mode.

**User response:** Check that the object is in the correct mode, and resubmit the command.

---

---

**CMMVC6060E** The action failed as the object is being deleted.

**Explanation:** The action failed because the object is being deleted.

**User response:** Not applicable.

---

**CMMVC6061E** The action failed as the object is being resized.

**Explanation:** The action failed because the object is being resized.

**User response:** Check that the object is in the correct mode, and resubmit the command.

---

**CMMVC6062E** The action failed as the object is being moved between HWS.

**Explanation:** An attempt was made to perform an action against an object that is currently being moved between I/O groups.

**User response:** Re-issue the command when the move operation has completed.

---

**CMMVC6063E** The action failed as there are no more disks in the group.

**Explanation:** An attempt was made to perform an action against a group that contained no disks.

**User response:** Either add disks to the group and reissue the command, or select another group against which to execute the action.

---

**CMMVC6064E** The action failed as the object has an invalid name.

**Explanation:** An attempt was made to create or rename an object using a name that is not valid.

**User response:** Use a name that meets the naming standards and reissue the command.

---

**CMMVC6065E** The action failed as the object is not in a group.

**Explanation:** An attempt was made to perform an action on an object that was not in an appropriate group.

**User response:** Ensure that the object is a member of an appropriate group and reissue the command.

---

**CMMVC6066E** The action failed as the system is running low on memory.

**Explanation:** The system is running low on memory.

**User response:** Not applicable.

---

---

**CMMVC6067E** The action failed as the SSH key was not found.

**Explanation:** An attempt was made to perform an action using an SSH key that does not exist.

**User response:** Reissue the command using a key that does exist.

---

**CMMVC6068E** The action failed as there are no free SSH keys.

**Explanation:** An attempt was made to use an SSH key when there are no free SSH keys.

**User response:** Upload additional keys and reissue the command.

---

**CMMVC6069E** The action failed as the SSH key is already registered.

**Explanation:** An attempt was made to register an SSH key that was already registered.

**User response:** Not applicable.

---

**CMMVC6070E** An invalid or duplicated parameter, unaccompanied argument, or incorrect argument sequence has been detected. Ensure that the input is as per the help.

**Explanation:** The parameters entered for a command were not valid.

**User response:** Correct the parameters and reissue the command.

---

**CMMVC6071E** The VDisk-to-host mapping was not created because the VDisk is already mapped to a host.

**Explanation:** The volume is already mapped to a host.

**User response:** Not applicable.

---

**CMMVC6073E** The maximum number of files has been exceeded.

**Explanation:** The maximum number of files has been exceeded.

**User response:** Not applicable.

---

**CMMVC6074E** The command failed as the extent has already been assigned.

**Explanation:** The command failed as the extent has already been assigned.

**User response:** Assign a different extent, and resubmit the command.

---

**CMMVC6075E** The expand failed as the last extent is not a complete extent.

**Explanation:** The expand failed as the last extent is not a complete extent.

**User response:** Assign a different extent, and resubmit the command.

---

**CMMVC6076E** The command failed because the virtual disk cache is not empty. Either wait for the cache to flush or use the force flag to discard the contents of the cache.

**Explanation:** The command failed due to an error during the flushing of the volume.

**User response:** Not applicable.

---

**CMMVC6077E** WARNING - Unfixed errors should be fixed before applying software upgrade. Depending on the nature of the errors, they might cause the upgrade process to fail. It is highly recommended to fix these errors before proceeding. If a particular error cannot be fixed, contact the support center.

**Explanation:** Unfixed errors should be fixed before applying software upgrade. Depending on the nature of the errors, they might cause the upgrade process to fail. It is highly recommended to fix these errors before proceeding.

**User response:** If the error cannot be fixed, contact the support center.

---

**CMMVC6078E** The action failed because the object is in an invalid mode.

**Explanation:** An attempt was made to perform an action against an object in a mode that did not allow for that action to be performed.

**User response:** Get the object into a suitable mode and reissue the command.

---

**CMMVC6079E** Metadata recovery could not complete the operation because a parameter is invalid.

**Explanation:** Metadata recovery could not complete the operation because a parameter is not valid.

**User response:**

---

**CMMVC6081E** Metadata Recovery is busy processing the previous operation.

**Explanation:** Metadata Recovery is busy processing the previous operation.

---

## CMMVC6082E • CMMVC6096E

User response:

---

**CMMVC6082E** The attempt to abort metadata recovery failed because the previous operation has completed.

**Explanation:** The attempt to cancel metadata recovery failed because the previous operation has completed.

**User response:** None.

---

**CMMVC6083E** Metadata recovery could not find a valid dumpfile required for the rebuild operation.

**Explanation:** Metadata recovery could not find a valid dumpfile required for the rebuild operation.

**User response:**

---

**CMMVC6084E** Metadata recovery could not create/open/write the scan file, the disk might be full.

**Explanation:** Metadata recovery could not create/open/write the scan file, the disk might be full.

**User response:**

---

**CMMVC6085E** Metadata recovery could not create/open/write the dump file, the disk might be full.

**Explanation:** Metadata recovery could not create/open/write the dump file, the disk might be full.

**User response:**

---

**CMMVC6086E** Metadata recovery could not create/open/write the progress file, the disk might be full.

**Explanation:** Metadata recovery could not create/open/write the progress file, the disk might be full.

**User response:**

---

**CMMVC6087E** Metadata recovery could not map the buffers necessary to complete the operation.

**Explanation:** Metadata recovery could not map the buffers necessary to complete the operation.

**User response:**

---

**CMMVC6088E** The lba at which metadata recovery was requested does not contain metadata.

**Explanation:** The lba at which metadata recovery was requested does not contain metadata.

**User response:**

---

**CMMVC6089E** The metadata at the requested lba is flagged as invalid.

**Explanation:** The metadata at the requested lba is flagged as not valid.

**User response:**

---

**CMMVC6090E** The metadata header checksum verification failed.

**Explanation:** The metadata header checksum verification failed.

**User response:**

---

**CMMVC6091E** The metadata region checksum verification failed.

**Explanation:** The metadata region checksum verification failed.

**User response:**

---

**CMMVC6092E** The metadata recovery operation was aborted.

**Explanation:** The metadata recovery operation was cancelled.

**User response:**

---

**CMMVC6093E** Metadata recovery internal error - (read only)

**Explanation:** Metadata recovery internal error - (read only)

**User response:**

---

**CMMVC6095E** Metadata recovery encountered the end of the disk.

**Explanation:** Metadata recovery encountered the end of the disk.

**User response:**

---

**CMMVC6096E** The metadata recovery task could not be initiated because the required back-end resource could not be found.

**Explanation:** The back-end resource that is required for the task is unavailable.



**User response:** Ensure that the required back-end resource is available, and reinitiate the task.

---

**CMMVC6097E** The metadata recovery task could not be initiated because the system was unable to send the required I/O to the back-end resource.

**Explanation:** The back-end resource is possibly not configured properly.

**User response:** Ensure that the required back-end resource is accessible, and reinitiate the task.

---

**CMMVC6098E** The copy failed as the specified node is the configuration node.

**Explanation:** The copy failed because the specified node is the configuration node.

**User response:** Not applicable.

---

**CMMVC6100E** *OPTION* not consistent with *ACTION*

**Explanation:** The specified option is not supported for the specified action.

**User response:** Remove the option, and resubmit the command.

---

**CMMVC6101E** *OPTION* not consistent with *OPTION*

**Explanation:** The two specified options cannot be used together.

**User response:** Remove one of the options, and resubmit the command.

---

**CMMVC6102E** *OPTION* and *OPTION* are alternatives

**Explanation:** The two specified options are alternatives, and cannot be used together.

**User response:** Remove one of the options, and resubmit the command.

---

**CMMVC6103E** Problem with *FILENAME* : *DETAILS*

**Explanation:** A problem occurred when opening the specified file. Determine the cause of the problem and correct it before trying again.

**User response:** Correct the problem, and resubmit the command.

---

**CMMVC6104E** Action *ACTION* not run

**Explanation:** An unexpected error has occurred.

**User response:** Contact IBM technical support for assistance.

---

**CMMVC6105E** Different names for source *SOURCE\_CLUSTER\_NAME* and target *TARGET\_CLUSTER\_NAME* clusters

**Explanation:** The backup configuration cannot be restored to the target cluster because the source and target cluster have different names.

**User response:** Perform one of the following actions: (1) Use a different backup configuration. (2) Delete the cluster and recreate it with the same name as that stored in the backup configuration file.

---

**CMMVC6106W** Target cluster has non-default *id\_alias ALIAS* .

**Explanation:** The specified *id\_alias* of the target cluster is a non-default value. Clusters should have the default value. The non-default value suggests that the cluster is customized and is not suitable for restoration. Restoration changes the *id\_alias*.

**User response:** Change the *id\_alias* to a default value, and resubmit the command.

---

**CMMVC6107E** *NUMBER\_OF\_OBJECTS* *io\_grp* objects in target cluster; *NUMBER\_OF\_REQUIRED\_OBJECTS* are required

**Explanation:** The number of I/O groups in the target cluster is not sufficient to accommodate the I/O groups defined in the backup configuration file. Determine why there are not enough I/O groups.

**User response:** Correct the problem, and resubmit the command.

---

**CMMVC6108I** Disk controller system with a WWNN of *WWNN\_VALUE* found.

**Explanation:** A disk controller system with the required WWNN has been found.

**User response:** Not applicable.

---

**CMMVC6109E** Disk controller system with a WWNN of *WWNN\_VALUE* not available.

**Explanation:** A disk controller system with the specified WWNN has been found. Ensure that the specified disk controller system is available to the cluster.

**User response:** Ensure that the required disk controller system is available to the cluster, and resubmit the command.

---

**CMMVC6110E** Bad code level: *VALUE* .

**Explanation:** An unexpected error has occurred.

**User response:** Contact IBM technical support for assistance.

---

**CMMVC6111E** The cluster code level could not be determined from *VALUE* .

**Explanation:** The code level of the cluster could not be determined. The code level should be of the format x.y.z, where x, y, and z are integers.

**User response:** If the cause of the problem cannot be determined, contact IBM technical support for assistance.

---

**CMMVC6112W** *OBJECT\_TYPE OBJECT\_NAME* has a default name.

**Explanation:** An object in the cluster has a default name. This can cause problems when restoring a cluster because default names are changed during restoration. Object IDs are also changed during restoration.

**User response:** Choose an appropriate name for each object in the cluster, and resubmit the command.

---

**CMMVC6113E** The command *COMMAND* has failed with return code *RETURN\_CODE* .

**Explanation:** An attempt to run a command remotely failed using secure communications.

**User response:** Determine the cause of the problem, and resubmit the command.

---

**CMMVC6114E** No help for action *ACTION* .

**Explanation:** There is no help for the specified action topic.

**User response:** Not applicable.

---

**CMMVC6115W** Feature *FEATURE\_PROPERTY* mismatch: *VALUE* expected; *VALUE* found.

**Explanation:** The features in the backup configuration file and the target cluster do not match. There should be an exact match between the two. Nevertheless, the restore of the configuration can continue.

**User response:** Not applicable.

---

**CMMVC6116I** Feature match for *FEATURE* .

**Explanation:** The features in the backup configuration file and the target cluster are an exact match.

**User response:** Not applicable.

---

---

**CMMVC6117E** *FIX\_OR\_FEATURE* is not available.

**Explanation:** An unexpected error has occurred.

**User response:** Contact IBM technical support for assistance.

---

**CMMVC6118I** *TYPE* with *PROPERTY PROPERTY\_VALUE* and *PROPERTY PROPERTY\_VALUE* found.

**Explanation:** An object in the cluster has been found with the correct properties.

**User response:** Not applicable.

---

**CMMVC6119E** *TYPE* with *PROPERTY PROPERTY\_VALUE* not found.

**Explanation:** An object in the cluster with the correct properties has not been found. Restoration cannot proceed without the object.

**User response:** Determine why the object cannot be found. Ensure that the object is available, and resubmit the command.

---

**CMMVC6120E** Target is not the configuration node

**Explanation:** The target is not the configuration node.

**User response:** Redirect the action against the configuration node, and resubmit the command.

---

**CMMVC6121E** No cluster id or id\_alias in backup configuration.

**Explanation:** Neither the cluster id\_alias nor the ID can be extracted from the backup configuration file.

**User response:** If the cause of the problem cannot be determined, contact IBM technical support for assistance.

---

**CMMVC6122E** No *TYPE* with *PROPERTY VALUE* is present in the table.

**Explanation:** An unexpected error has occurred.

**User response:** Contact IBM technical support for assistance.

---

**CMMVC6123E** No *PROPERTY* for *TYPE NAME* .

**Explanation:** An unexpected error has occurred.

**User response:** Contact IBM technical support for assistance.

---

---

**CMMVC6124E** No *TYPE* with *PROPERTY VALUE*

**Explanation:** An unexpected error has occurred.

**User response:** Contact IBM technical support for assistance.

---

**CMMVC6125E** No unique ID for *TYPE NAME*

**Explanation:** An unexpected error has occurred.

**User response:** Contact IBM technical support for assistance.

---

**CMMVC6126E** No *TYPE* with unique ID *VALUE*

**Explanation:** An unexpected error has occurred.

**User response:** Contact IBM technical support for assistance.

---

**CMMVC6127I** The SSH key *IDENTIFIER* for *USER* is already defined; the SSH key will not be restored

**Explanation:** An identical SSH key for this user is already defined on the cluster. Therefore, the key in the backup file will not be restored.

**User response:** Specify a different SSH key, and resubmit the command.

---

**CMMVC6128W** *DIRECTORY*

**Explanation:** The files in the specified directory cannot be listed.

**User response:** Determine why the files cannot be listed, correct the problem, and resubmit the command.

---

**CMMVC6129E** VDisk-to-host mapping objects have VDisk\_UID values that are not consistent.

**Explanation:** All of the host mapping objects do not have the same number for the volume LUN instance. Therefore, there is a possibility the backup configuration file is corrupt. The LUN instance number should be the same for all host mapping objects that are associated with a specific volume. The LUN instance number is incorporated into the volume ID property.

**User response:** Determine why the LUN instance number is not the same, correct the problem, and resubmit the command.

---

**CMMVC6130W** Inter-cluster *PROPERTY VALUE* will not be restored.

**Explanation:** The restoration of inter-cluster objects is not supported.

**User response:** Not applicable.

---



---

**CMMVC6131E** No location cluster information

**Explanation:** An unexpected error has occurred.

**User response:** Contact IBM technical support for assistance.

---

**CMMVC6132E** The object *OBJECT* of type *TYPE* has a property *PROPERTY* with an incorrect value *INCORRECT\_VALUE*. The operation cannot proceed until the property has the correct value *CORRECT\_VALUE*. Take administrative action to change the value and try again.

**Explanation:** The specified object has the specified property of the specified type with the specified incorrect value. The property most likely reflects the state of the object.

**User response:** Change the state to the required value, and resubmit the command.

---

**CMMVC6133E** Required *TYPE* property *PROPERTY* not found

**Explanation:** An unexpected error has occurred.

**User response:** Contact IBM technical support for assistance.

---

**CMMVC6134E** No argument for *OPTION*

**Explanation:** No argument has been supplied for the specified option, which requires an argument.

**User response:** Supply an argument, and resubmit the command.

---

**CMMVC6135E** Argument *VALUE* for *OPTION* is not valid.

**Explanation:** The specified argument that you have supplied is not valid for the specified option.

**User response:** Supply a valid argument, and resubmit the command.

---

**CMMVC6136W** No SSH key file *FILENAME*

**Explanation:** The specified file, which should contain the SSH key, is not present and will not be restored. The backup operation will continue.

**User response:** No action is required. You might have to manually restore the key.

---

**CMMVC6137W** No SSH key file *FILENAME*; key not restored

**Explanation:** An SSH key cannot be restored because the specified file, which is expected to contain the SSH key, is not present. The restore operation will continue.

---

**User response:** After the restore is complete, locate the file containing the key, and perform one of the following actions: (1) Rename the file so that it has the correct name, and resubmit the command. (2) Restore the key manually using the **addsshkey** command.

---

**CMMVC6138E** *OPTION* is required

**Explanation:** An option is missing. The option might be listed as optional, but circumstances make the option mandatory.

**User response:** Supply the option, and resubmit the command.

---

**CMMVC6139E** Incorrect XML tag nesting in *FILENAME*

**Explanation:** There is a problem with the content of a configuration file. There is a problem parsing the XML in the file, because the XML records are not consistent. The file might be corrupt, or the file has been truncated.

**User response:** Replace this copy with a good copy, and resubmit the command. If the problem persists, contact IBM technical support for assistance.

---

**CMMVC6140E** No default name for type *TYPE*

**Explanation:** An unexpected error has occurred.

**User response:** Contact IBM technical support for assistance.

---

**CMMVC6141E** The option *OPTION* does not support an argument.

**Explanation:** An argument has been supplied for an option that does not support one.

**User response:** Remove the argument, and resubmit the command.

---

**CMMVC6142E** Existing *OBJECT\_TYPE* *OBJECT\_NAME* has a non-default name.

**Explanation:** The specified object in the target default cluster has a non-default name. This suggests that the cluster was customized. The cluster is therefore not suitable for restoration.

**User response:** Reset the cluster as per the instructions for restoring the cluster configuration, and resubmit the command.

---

**CMMVC6143E** The required configuration file *FILENAME* does not exist.

**Explanation:** A file that is critical for successful operation is missing.

**User response:** Not applicable.

---

**CMMVC6144W** The object with default name *NAME* has been restored as *SUBSTITUTE\_NAME*.

**Explanation:** An object with a default name has been restored with a different name. Ensure that you account for this name change when using the restored cluster in the future. To avoid this problem in the future, choose an appropriate name for each object in the cluster.

**User response:** Choose an appropriate name for each object in the cluster.

---

**CMMVC6145I** First use the *COMMAND* -prepare command.

**Explanation:** This advisory is given prior to CMMVC6103E when an intermediate file is missing.

**User response:** Not applicable.

---

**CMMVC6146E** Problem parsing *OBJECT\_TYPE* data: *LINE*

**Explanation:** An unexpected error has occurred.

**User response:** Contact the support center.

---

**CMMVC6147E** *TYPE NAME* has a name beginning with *PREFIX*.

**Explanation:** An object has been encountered that has a name beginning with the specified reserved prefix. The only valid reason for an object with this kind of name is that a restoration command did not complete successfully.

**User response:** Ensure that no object uses the reserved prefix in its name, and resubmit the command.

---

**CMMVC6148E** Target cluster has *NUMBER\_OF\_EXISTING\_OBJECTS* objects of type *TYPE* instead of *NUMBER\_OF\_REQUIRED\_OBJECTS*.

**Explanation:** The target cluster does not have the specified required number of objects of the specified type.

**User response:** Correct the problem, and resubmit the command.

---

**CMMVC6149E** An action is required.

**Explanation:** An action is required to run the command.

**User response:** Supply an action, and resubmit the command.

---

**CMMVC6150E** The action *ACTION* is not valid.

**Explanation:** The specified action that you have entered is not valid.

**User response:** Specify a valid action, and resubmit the command.

---

**CMMVC6151E** The option *OPTION* is not valid.

**Explanation:** The specified option that you have entered is not valid.

**User response:** Specify a valid option, and resubmit the command.

---

**CMMVC6152E** VDisk *VDISK\_NAME* instance number *INSTANCE\_NUMBER* is not valid.

**Explanation:** The volume cannot be restored because the instance number, which must be a hexadecimal number, is not valid.

**User response:** Contact IBM technical support for assistance.

---

**CMMVC6153E** *OBJECT* not consistent with *ACTION*

**Explanation:** The specified object is not supported for the specified action.

**User response:** Remove the object, and resubmit the command.

---

**CMMVC6154E** Required *OBJECT\_TYPE* property *PROPERTY\_NAME* has a null value.

**Explanation:** An unexpected error has occurred.

**User response:** Contact IBM technical support for assistance.

---

**CMMVC6155I** The command *COMMAND* processing has completed successfully.

**Explanation:** Only information and warning messages are issued.

**User response:** Not applicable.

---

**CMMVC6156W** *COMMAND* processing completed with errors.

**Explanation:** Processing was not successful.

**User response:** Not applicable.

---

**CMMVC6164E** The SVCCONFIG CRON job, which runs overnight on a daily overnight, has failed.

**Explanation:** The SVCCONFIG CRON job, which runs overnight on a daily overnight, has failed.

**User response:** Resolve any hardware and configuration problems that you are experiencing on the 2145 cluster. If the problem persists, contact IBM technical support for assistance.

---

**CMMVC6165E** The target is not the original configuration node with a WWNN of *WWNN\_VALUE* .

**Explanation:** A backup configuration can only be restored to the original configuration node.

**User response:** Recreate the default cluster with the correct configuration node, and resubmit the command.

---

**CMMVC6166E** The property *PROPERTY* of the object *OBJECT* has changed during *svconfig restore -execute*.

**Explanation:** The integrity of the restoration cannot be guaranteed.

**User response:** Resubmit the command from *svconfig restore -prepare*.

---

**CMMVC6181E** The target cluster contains an object that has a counterpart in the configuration to be restored, and has the correct ID.

**Explanation:** The indicated property has an unexpected value.

**User response:** Check that the correct (matching) backup configuration file (*svc.config.backup.xml*) is being provided and if it is, use the *-force* option to ignore the discrepancy. Otherwise, provide the correct file and try again.

---

**CMMVC6182W** An object that does not contribute to the fabric of the configuration cannot be restored because its configuration does not permit it to be created.

**Explanation:** An object that does not contribute to the fabric of the configuration cannot be restored because its configuration does not permit it to be created. For example, a host can only be created if it has at least one port.

**User response:** Not applicable.

---

**CMMVC6186W** The IO group *IO\_GROUP\_NAME* has been restored with ID *ID\_VALUE* instead of *ID\_VALUE* .

**Explanation:** This can occur when the configuration node is different from the node that was used to create the original cluster. This affects the SCSI Inquiry value for the I/O group.

**User response:** Not applicable.

---

**CMMVC6200E** The action failed because of incompatible software.

**Explanation:** The software version on one or more nodes is incompatible with the new version.

**User response:** Refer to the compatibility requirements for the software version you are adding. Update the cluster to meet the compatibility requirements, and then perform the upgrade.

---

**CMMVC6201E** The node could not be added because of incompatible software. The status code is *STATUS\_CODE* .

**Explanation:** The node could not be added because of incompatible software.

**User response:** Upgrade the software on the node that has been rejected to the same level of software as the cluster to which it will be added, and resubmit the command.

---

**CMMVC6202E** The cluster was not modified because the IP address is not valid.

**Explanation:** An attempt was made to change the IP address of a cluster to an address that is not valid.

**User response:** Correct the address and reissue the command.

---

**CMMVC6203E** The action failed because the directory that was specified was not one of the following directories: */dumps*, */dumps/iostats*, */dumps/iotrace*, */dumps/feature*, */dumps/config*, */dumps/elog*s, */dumps/ec* or */dumps/pl*.

**Explanation:** An attempt was made to clear a file from, or copy a file to, a directory that is not valid.

**User response:** Ensure that the command accesses a valid directory.

---

**CMMVC6204E** The action failed as the resulting disk size would be less than, or equal to, zero.

**Explanation:** An attempt was made to shrink a disk, however the resulting size would have been less than or equal to zero.

**User response:** Not applicable

---

**CMMVC6205E** Metadata recovery can not use the provided MDisk id - invalid or destroyed.

**Explanation:** Metadata recovery cannot use the provided MDisk id, which is not valid or destroyed.

**User response:**

---

**CMMVC6206E** The software upgrade failed as a file containing the software for the specified MCP version was not found.

**Explanation:** There are two files required to successfully complete a software upgrade. One file contains the files that make up the base operating system, and the other file contains the 2145 software. This message appears if the OS version is incompatible with the 2145 software.

**User response:** Upload two compatible files, and resubmit the command.

---

**CMMVC6207E** The action failed because the virtual disk (VDisk) is part of a Remote Copy mapping.

**Explanation:** An action was performed against a volume that is part of a Remote Copy mapping.

**User response:** Remove the volume from the Remote Copy mapping before resubmitting the command.

---

**CMMVC6208E** The action failed because the virtual disk (VDisk) is part of a FlashCopy mapping.

**Explanation:** An action was performed against a volume that is part of a FlashCopy mapping.

**User response:** Remove the volume from the FlashCopy mapping before reissuing the command.

---

**CMMVC6209E** The FlashCopy mapping or consistency group could not be started in a reasonable time. The mapping or group is instead being prepared.

**Explanation:** The FlashCopy mapping or consistency group could not be started in a reasonable time. The mapping or group is instead being prepared.

**User response:** Resubmit the command.

---

**CMMVC6210E** The command has failed because a virtual medium error exists on the image mode VDisk or copy.

**Explanation:** When you submit this command, you cannot specify an image mode volume that has a virtual medium error on the volume or on any copy of the volume because the medium errors cannot be maintained on the ejected MDisk image copy.

**User response:** If an exact image copy is required, ensure that there is no virtual medium error on the image mode volume that you specify or on any of its copies, and resubmit the command.

If an exact copy is not required, you can use the *-force* option of the command, but all of the virtual medium errors will be lost.

---

**CMMVC6211E** The command failed as a migrate to image was in progress.

**Explanation:** An attempt was made to execute a command against a volume that was involved in a migrate to image operation.

**User response:** Wait for the migration to complete and reissue the command.

---

**CMMVC6212E** The command failed because data in the cache has not been committed to disk.

**Explanation:** The command failed because data in the cache has not been committed to disk.

**User response:**

---

**CMMVC6213E** You are trying to recover region data that was created by a code level different from the one you are currently running on the node.

**Explanation:** You are trying to recover region data that was created by a code level different from the one you are currently running on the node.

**User response:**

---

**CMMVC6214E** Failed to recreate the cluster you are trying to rebuild.

**Explanation:** Failed to recreate the cluster you are trying to rebuild.

**User response:**

---

**CMMVC6215E** The FlashCopy mapping was not created or modified because the consistency group already contains the maximum number of mappings.

**Explanation:** An attempt was made to create a FlashCopy mapping in, or move a FlashCopy mapping to, a consistency group that has the maximum number of FlashCopy mappings that it can contain.

**User response:** Create or move the FlashCopy mapping in another consistency group or remove an existing FlashCopy mapping from the desired group and then reissue the command.

---

**CMMVC6216E** The Remote Copy relationship was not created because the master or auxiliary virtual disk (VDisk) is a member of a Remote Copy mapping.

**Explanation:** The Remote Copy relationship was not created because the master or auxiliary volume is a member of a Remote Copy mapping.

**User response:** Select a different volume to make up the mapping.

---

**CMMVC6217E** The maximum number of hosts for the cluster is already configured.

**Explanation:** You must remove at least one host definition before you can resubmit the command.

**User response:** Determine whether the action is required.

If the action is required, review the current configuration to determine whether any current host definitions are not required. Remove at least one host definition that is not required, and resubmit the command.

---

**CMMVC6218E** The maximum number of host/IO group pairs for the cluster is already configured.

**Explanation:** You must remove at least one host I/O group pair definition before you can resubmit the command.

**User response:** Determine whether the action is required.

If the action is required, review the current configuration to determine whether any current host I/O group pair definitions are not required. Remove at least one host I/O group pair definition that is not required, and resubmit the command.

---

**CMMVC6219E** The maximum number of WWPNS for the cluster is already configured.

**Explanation:** You must remove at least one WWPNS definition before you can resubmit the command.

**User response:** Determine whether the action is required.

If the action is required, review the current configuration to determine whether any current WWPNS definitions are not required. Remove at least one WWPNS definition that is not required, and resubmit the command.

---

**CMMVC6220E** The maximum number of hosts for one or more IO groups is already configured.

**Explanation:** You must remove at least one host I/O group pair definition from the I/O group that you have specified before you can resubmit the command.

**User response:** Determine whether the action is required.

If the action is required, review the current configuration to determine whether any current host I/O group pair definitions for the I/O group that you

## CMMVC6221E • CMMVC6230E

have specified are not required. Remove at least one host I/O group pair definition that is not required from the I/O group that you have specified, and resubmit the command.

---

**CMMVC6221E** The maximum number of WWPNs for one or more IO groups is already configured.

**Explanation:** You must remove at least one WWPN definition from the I/O group that you have specified before you can resubmit the command.

**User response:** Determine whether the action is required.

If the action is required, review the current configuration to determine whether any current WWPN definitions for the I/O group that you have specified are not required. Remove at least one WWPN definition that is not required from the I/O group that you have specified, and resubmit the command.

---

**CMMVC6222E** The maximum number of WWPNs for the host is already configured.

**Explanation:** You must remove at least one WWPN definition for the host that you have specified before you can resubmit the command.

**User response:** Determine whether the action is required.

If the action is required, review the current configuration to determine whether any current WWPN definitions for the host that you have specified are not required. Remove at least one WWPN definition that is not required for the host that you have specified, and resubmit the command.

---

**CMMVC6223E** The host does not belong to one or more of the IO groups specified or inferred.

**Explanation:** The host does not belong to one or more of the I/O groups specified or inferred.

**User response:** Specify a host I/O group combination that is currently defined, and resubmit the command.

---

**CMMVC6224E** The host already belongs to one or more of the IO groups specified.

**Explanation:** The host already belongs to one or more of the I/O groups specified.

**User response:** None.

---

**CMMVC6225E** An IO group cannot be removed from a host because of one or more associated VDisks.

**Explanation:** An I/O group cannot be removed from a host because of one or more associated volumes.

**User response:**

---

**CMMVC6226E** The action was not completed because the cluster has reached the maximum number of extents in MDisk groups.

**Explanation:** The cluster has reached the maximum number of extents in the storage pool; therefore, the action did not complete. You are attempting to use additional extents, for example by creating or expanding a volume. The action cannot be initiated because it would cause the maximum number of extents for a cluster to be exceeded.

**User response:** Free up extents by deleting other volumes, and resubmit the command.

---

**CMMVC6227I** The package installed successfully.

**Explanation:** The package installed successfully.

**User response:** None.

---

**CMMVC6228E** The cluster was recovered and the CLI functionality is limited until the cause of the failure is determined and any corrective action taken. Contact IBM technical support for assistance.

**Explanation:** The cluster was recovered and the CLI functionality is limited.

**User response:** Contact IBM technical support for assistance.

---

**CMMVC6229E** The action failed as the SSH key has been revoked.

**Explanation:** The action failed as the SSH key has been revoked.

**User response:**

---

**CMMVC6230E** The action failed as the SSH key index (SSH\_LABEL\_ID) is invalid.

**Explanation:** The action failed as the SSH key index (SSH\_LABEL\_ID) is not valid.

**User response:**

---



---

**CMMVC6231E** The action failed as the audit table is full.

**Explanation:** The action failed as the audit table is full.

**User response:** Save the audit log to disk, and resubmit the command.

---

**CMMVC6232E** This operation cannot be performed because the cluster is currently aborting the previous software upgrade command.

**Explanation:** This operation cannot be performed because the cluster is currently cancelling the previous software upgrade command.

**User response:** Wait until the previous software upgrade command has cancelled successfully, and resubmit the command.

---

**CMMVC6233E** This operation cannot be performed because, either a software upgrade has not been started, or a software upgrade is in progress but is not in a state where it can be aborted.

**Explanation:** This operation cannot be performed because the software upgrade is making progress.

**User response:**

---

**CMMVC6234E** The upgrade cannot be aborted because at least one node has already committed to a new code level.

**Explanation:** The upgrade cannot be cancelled because at least one node has already committed to a new code level.

**User response:**

---

**CMMVC6235E** An invalid response has been entered. The command has not been executed. Input is case sensitive. Enter either yes or no.

**Explanation:** A response that is not valid has been entered. The command has not been executed.

**User response:** Enter either yes or no.

---

**CMMVC6236E** The command has not completed. A limited availability parameter has been entered without the required environment setting being set.

**Explanation:** The command has not completed. A limited availability parameter has been entered without the required environment setting being set.

**User response:**

---

**CMMVC6237E** The command failed as the remote cluster does not support global mirror.

**Explanation:** The command failed as the remote cluster does not support global mirror.

**User response:**

---

**CMMVC6238E** The copy type differs from other copies already in the consistency group.

**Explanation:** The copy type differs from other copies already in the consistency group.

**User response:** Ensure that the copy type of the mapping that you are attempting to add is the same copy type as the mappings in the consistency group to which you are attempting to add the mapping, and resubmit the command.

---

**CMMVC6239E** The FlashCopy mapping was not prepared because the mapping or consistency group is in the stopping state. The mapping or consistency group must first complete the stop operation and then be prepared

**Explanation:** You cannot prepare a FlashCopy mapping or consistency group when the FlashCopy mapping or consistency group is in the stopping state. If you want to prepare a FlashCopy mapping or consistency group, the FlashCopy mapping or consistency group must be in the Stopped or idle\_or\_copied state.

**User response:** Wait until the FlashCopy mapping or consistency group reaches the Stopped or idle\_or\_copied state and then resubmit the command.

---

**CMMVC6240E** The properties of the FlashCopy mapping were not modified because the mapping or consistency group is in the stopping state.

**Explanation:** You cannot modify the consistency group of a FlashCopy mapping when the FlashCopy mapping is in the stopping state. If you want to modify the consistency group of a FlashCopy mapping, the FlashCopy mapping must be in the Stopped or idle\_or\_copied state.

**User response:** Wait until the FlashCopy mapping reaches the Stopped or idle\_or\_copied state and then resubmit the command.

---

**CMMVC6241E** The FlashCopy mapping was not deleted because the mapping or consistency group is in the stopping state. The mapping or consistency group must be stopped first.

**Explanation:** You cannot delete a FlashCopy mapping or consistency group when the FlashCopy mapping or

consistency group is in the stopping state. If you want to delete a FlashCopy mapping or consistency group, the FlashCopy mapping or consistency group must be in the Stopped or idle\_or\_copied state.

**User response:** Wait until the FlashCopy mapping or consistency group reaches the Stopped or idle\_or\_copied state and then resubmit the command.

**CMMVC6242E The FlashCopy mapping or consistency group was not started because the mapping or consistency group is in the stopping state. The mapping or consistency group must first complete the stop operation and then be prepared.**

**Explanation:** You cannot start a FlashCopy mapping or consistency group when the FlashCopy mapping or consistency group is in the stopping state. If you want to start a FlashCopy mapping or consistency group, the FlashCopy mapping or consistency group must be in the Prepared state.

**User response:** Wait until the FlashCopy mapping or consistency group reaches the Stopped or idle\_or\_copied state and then prepare the FlashCopy mapping or consistency group before starting it.

**CMMVC6243E The FlashCopy mapping or consistency group was not stopped because the mapping or consistency group is already in the stopping state.**

**Explanation:** A Stop FlashCopy mapping or consistency group task has already been submitted and is still in progress. When the task has completed successfully, the FlashCopy mapping or consistency group state will change to Stopped.

**User response:** None.

**CMMVC6244E The FlashCopy mapping was not created because the source virtual disk (VDisk) cannot be the target for a FlashCopy mapping.**

**Explanation:** A volume cannot simultaneously be both the source of a FlashCopy mapping and the target of a FlashCopy mapping. The source volume that you have specified is currently defined as the target of a FlashCopy mapping.

**User response:** You have two options. One option is specify a different source volume and resubmit the command. The other option is delete the existing FlashCopy mapping that defines the source volume that you have specified as the target volume, and resubmit the command.

**CMMVC6245E The FlashCopy mapping was not created because the source virtual disk (VDisk) is already in the maximum number of FlashCopy mappings.**

**Explanation:** The number of FlashCopy mappings in which a volume can be defined as the source volume is limited. The source volume that you have specified cannot be defined to another FlashCopy mapping because it is already defined as the source volume to the maximum number of FlashCopy mappings.

**User response:** You have two options. One option is specify a different source volume and resubmit the command. The other option is delete one of the existing FlashCopy mappings that contains the source volume and resubmit the command.

**CMMVC6246E The FlashCopy mapping was not created because the target virtual disk (VDisk) is already a source VDisk in a FlashCopy mapping.**

**Explanation:** A volume cannot simultaneously be both the source of a FlashCopy mapping and the target of a FlashCopy mapping. The target volume that you have specified is currently defined as the source of a FlashCopy mapping.

**User response:** You have two options. One option is specify a different target volume and resubmit the command. The other option is delete all of the existing FlashCopy mappings that contain the target volume that you have specified and resubmit the command.

**CMMVC6247E The FlashCopy mapping was not created because the target virtual disk (VDisk) is already a target VDisk in a FlashCopy mapping.**

**Explanation:** A volume cannot simultaneously be the target of more than one FlashCopy mapping. The target volume that you have specified is currently defined as the target of another FlashCopy mapping.

**User response:** You have two options. One option is specify a different target volume and resubmit the command. The other option is delete the existing FlashCopy mapping that contains the target volume that you have specified and resubmit the command.

**CMMVC6248E The command failed because the authorization table is full.**

**Explanation:** The command failed because the authorization table is full.

**User response:**

---

**CMMVC6249E** The command failed because the authorization record was not found or is already set to the default role.

**Explanation:** The command failed because the authorization record was not found or is already set to the default role.

**User response:**

---

**CMMVC6250E** The command failed because the authorization record is not set to the default role. Use `rmauth` to set the default role.

**Explanation:** The command failed because the authorization record is not set to the default role.

**User response:** Use `rmauth` to set the default role.

---

**CMMVC6251E** The command failed because the specified role was not found.

**Explanation:** The command failed because the specified role was not found.

**User response:**

---

**CMMVC6252E** The command failed authorization because the session SSH key is invalid or was deleted.

**Explanation:** The command failed authorization because the session SSH key is not valid or was deleted.

**User response:**

---

**CMMVC6253E** The task has failed because the user's role is not authorized to submit the command.

**Explanation:** One example of a user role restriction is that a user that has a role of Monitor cannot create a volume.

**User response:** Either log in as a user that has a role that is authorized to submit the task or change the role of the user account that you are using to a role that is authorized to submit the task, and resubmit the task.

---

**CMMVC6254E** The command failed because the specified SSH key was not found. **NOTE** This command must specify an admin key.

**Explanation:** The command failed because the specified SSH key was not found. This command must specify an admin key.

**User response:**

---

**CMMVC6255E** The command cannot set the authorization record to the default role. Use `rmauth` to set the default role.

**Explanation:** The command can not set the authorization record to the default role.

**User response:** Use `rmauth` to set the default role.

---

**CMMVC6263E** The command failed because the SSH key already exists or there is a duplicate SSH key.

**Explanation:** You have attempted to add an SSH key that already exists, and may have a different authorization level associated with it.

**User response:** Add a different SSH key if the existing SSH key of the same type does not have the authority level that you require.

---

**CMMVC6269E** Sendmail error EX\_USAGE. A command or configuration line has been used incorrectly.

**Explanation:** The send email task has failed because a command or a configuration line has been used incorrectly.

**User response:** Ensure that the email settings are correct, and resubmit the task.

---

**CMMVC6270E** Sendmail error EX\_DATAERR. Address is wrong, or the message is too large for the mailbox.

**Explanation:** The send email task has failed because the message sent is too large or a recipient address is incorrect.

**User response:** Ensure that all addresses are correct and that the message is not too large, and resubmit the task.

---

**CMMVC6271E** Sendmail error EX\_NOINPUT. An input file (not a system file) did not exist or was not readable.

**Explanation:** The send email task has failed because a file is missing or cannot be read.

**User response:** Ensure that the email system is configured correctly. Ensure that access permissions have been specified correctly for all email configuration files, and resubmit the task.

---

**CMMVC6272E** Sendmail error EX\_NOUSER. The sendmail command could not recognize a specified user.

**Explanation:** The send email task has failed because the user and domain combination that you specified does not exist.

## CMMVC6273E • CMMVC6282E

**User response:** Specify a defined user and domain combination, and resubmit the task.

---

**CMMVC6273E Sendmail error EX\_NOHOST. The sendmail command could not recognize the specified host name.**

**Explanation:** The send email task has failed because the host is not known to the email system.

**User response:** Ensure that you have configured the SMTP environment correctly. Ensure that you specify a defined host, and resubmit the task.

---

**CMMVC6274E Sendmail error EX\_UNAVAILABLE. A required system resource is not available.**

**Explanation:** The send email task has failed because a required system resource is not available.

**User response:** Ensure that you have configured the SMTP environment correctly, and resubmit the task.

---

**CMMVC6275E Sendmail error EX\_SOFTWARE. An internal software error occurred (including bad arguments).**

**Explanation:** The send email task has failed because an incorrect parameter or parameter value has been detected.

**User response:** Ensure that you have configured the SMTP environment correctly. Specify only supported parameters and parameter values, and resubmit the task.

---

**CMMVC6276E Sendmail error EX\_OSERR. A system resource error prevented the sending of an email.**

**Explanation:** The send email task has failed because a system resource error has occurred.

**User response:** Ensure that you have configured the SMTP environment correctly, and resubmit the task.

---

**CMMVC6277E Sendmail error EX\_OSFILE. Failed to open a critical system file.**

**Explanation:** The send email task has failed because a required system file cannot be opened.

**User response:** Ensure that the email system is configured correctly. Ensure that access permissions have been specified correctly for all email configuration files, and resubmit the task.

---

**CMMVC6278E Sendmail error EX\_CANTCREAT. An output file could not be written to by sendmail.**

**Explanation:** The send email task has failed because the system cannot write to a required output file.

**User response:** Ensure that the email system is configured correctly. Ensure that access permissions have been specified correctly for all email configuration files, and resubmit the task.

---

**CMMVC6279E Sendmail error EX\_IOERR. A system I/O error occurred during a sendmail operation. This could be due to a disk failure.**

**Explanation:** The send email task has failed because a write or read I/O operation has failed. This error might be caused by a disk device failure.

**User response:** Correct the root cause of the I/O failure, and resubmit the task.

---

**CMMVC6280E Sendmail error EX\_TEMPFAIL. The sendmail command could not create a connection to a remote system.**

**Explanation:** The send email task has failed because the sendmail application cannot establish a connection to the remote system.

**User response:** Ensure that the network connection to the remote system is functioning correctly, and resubmit the task.

---

**CMMVC6281E Sendmail error EX\_PROTOCOL. The remote system returned something that was incorrect during a protocol exchange.**

**Explanation:** The send email task has failed because an error in the protocol exchange has occurred.

**User response:** Ensure that the email system is configured correctly. Ensure that you have configured the SMTP environment correctly, and resubmit the task.

---

**CMMVC6282E Sendmail error EX\_NOPERM. The user does not have permission to perform the requested operation.**

**Explanation:** The send email task has failed because the User ID does not have authorization to submit the task.

**User response:** Ensure that authorizations for your User ID in the email and SMTP configurations are correct, and resubmit the task.

---

---

**CMMVC6283E Sendmail error EX\_CONFIG. There is a fatal problem with the sendmail configuration.**

**Explanation:** The send email task has failed because the sendmail configuration is not correct.

**User response:** Ensure that the email system is configured correctly. Ensure that you have configured the SMTP environment correctly, and resubmit the task.

---

**CMMVC6284E An unknown error occurred. Please ensure your SMTP server is running.**

**Explanation:** The send email task has failed because an unexpected error has occurred.

**User response:** Ensure that the SMTP server is running, and resubmit the task.

---

**CMMVC6285E The email command timed out. Please check your email server settings as listed on the cluster.**

**Explanation:** The send email task has failed because a command timeout has occurred.

**User response:** Ensure that your system settings match those recommended in the sendmail application documentation, and resubmit the task.

---

**CMMVC6286E The email service has not been enabled.**

**Explanation:** The send email task has failed because the email application is not enabled.

**User response:** Enable the email application, and resubmit the task.

---

**CMMVC6287E The user specified does not exist.**

**Explanation:** You must specify a User ID that exists.

**User response:** Ensure that the User ID that you specify is defined, and resubmit the task.

---

**CMMVC6288E The FlashCopy mapping or consistency group could not be started because a source VDisk is the target of another FC Map that is keeping the VDisk inaccessible.**

**Explanation:** You cannot start a FlashCopy mapping or consistency group when a source volume in the FlashCopy mapping or consistency group is the target volume of another FlashCopy mapping that is holding the volume as inaccessible. The task cannot be initiated because a source volume in the FlashCopy mapping or consistency group that you are attempting to start is the target of another FlashCopy mapping that is either prepared, preparing, stopped or stopping with a progress of less than 100%.

**User response:** Ensure that you have selected to start the correct FlashCopy mapping or consistency group. Ensure that none of the source volumes in the FlashCopy mapping or consistency group that you specify are target volumes in another FlashCopy mapping that is prepared, preparing, stopped or stopping with a progress of less than 100%. Resubmit the task.

---

**CMMVC6289E The command failed because the virtual disk (VDisk) is pending synchronization.**

**Explanation:** This error occurs when at least one of the volume copies is offline.

**User response:** Fix all of the errors that are associated with the volume copies, and resubmit the command.

---

**CMMVC6290E The command failed because the virtual disk (VDisk) has image mode copies, is pending synchronization and -force has not been specified.**

**Explanation:** This error occurs when at least one of the volume copies is offline.

**User response:** Perform one of the following actions:

- Fix all of the errors that are associated with the volume copies, and resubmit the command.
- Resubmit the command and specify the -force parameter.

**Note:** When you specify the -force parameter with the command that caused this error, the image mode volume copy is no longer guaranteed to have the correct volume data.

---

**CMMVC6291E The command failed because the virtual disk (VDisk) is pending synchronization and -force has not been specified.**

**Explanation:** The command failed because the volume is pending synchronization and -force has not been specified.

**User response:** Perform one of the following actions:

- Fix all of the errors that are associated with the volume copies, and resubmit the command.
- Resubmit the command and specify the -force parameter.

**Note:** When you specify the -force parameter with the command that caused this error, the entire volume copy is resynchronized.

---

**CMMVC6292E** The command failed because a repair action is in progress for the virtual disk (VDisk).

**Explanation:** You cannot submit this command while a repair action is in progress for the volume.

**User response:** Use the `lsrepairvdiskcopyprogress` command to view the repair progress. Wait for the volume repair process to complete. If you want the repair process to complete more quickly, increase the rate by submitting a `chvdisk` command. Once the repair action has completed, resubmit the command that caused this error.

- Ensure that the controller settings are correct and that the MDisk logical unit is correctly configured.
- Ensure that the MDisk logical unit state is one that passes the validation. A Read Only or faulty MDisk fails the validation.
- Check the Fibre Channel fabric and storage controller for faults that might reduce the reliability of cluster communication with the MDisk.
- View the cluster event log for more information about the failed validation.

---

**CMMVC6296E** One or more managed disks (MDisks) have failed validation tests. The first failing MDisk ID is `MDISK_ID`.

**Explanation:** When you add a managed MDisk to a storage pool, the new MDisk is validated to ensure that adding it to the storage pool will not adversely impact the storage pool status. Either the current status of the MDisk has not allowed the validation to be performed, or the validation has failed. Note: You cannot add Read Only or faulty MDisks to a storage pool.

**User response:**

- If the MDisk identity has changed since it was last discovered, submit the command-line interface command `detectmdisk`, which might correct the problem.
- Check switch zoning and logical unit presentation on the controller to ensure that the MDisk is physically and logically connected to all of the nodes in this cluster.
- Ensure that the controller settings are correct and that the MDisk logical unit is correctly configured.
- Ensure that the MDisk logical unit state is one that passes the validation. A Read Only or faulty MDisk fails the validation.
- View the cluster event log for more information about the failed validation.

---

**CMMVC6298E** The command failed because a target VDisk has dependent FlashCopy mappings.

**Explanation:** The target volume of the FlashCopy mapping, or the target volume of at least one of the FlashCopy mappings in the consistency group, has other FlashCopy mappings that are dependent on the data on the target volume.

**User response:** Use the `lsvdiskdependentmaps` command and specify the target volume to determine which FlashCopy mappings are dependent on the target volume. Either wait for these mappings to reach the `idle_or_copied` state, or stop these mappings. Resubmit the command that produced this error.

---

**CMMVC6299E** The create failed because the source and target VDisks are members of FlashCopy mappings that have different grain sizes.

**Explanation:** All FlashCopy mappings that are in a tree of connected mappings must have the same grain size. The new FlashCopy mapping that you attempted to create would have linked two existing trees that have different grain sizes.

**User response:** You have three options. The first option is to resubmit the command and specify a different source or target volume. The second option is to delete all of the existing mappings that contain the source volume and resubmit the command. The third option is to delete all of the existing mappings that contain the target volume and resubmit the command.

---

**CMMVC6297E** One or more managed disks (MDisks) have timed out during validation tests. The first failing MDisk ID is `MDISK_ID`.

**Explanation:** When you add a managed MDisk to a storage pool, the new MDisk is validated to ensure that adding it to the storage pool will not adversely impact the storage pool status. The current status of the MDisk permits the validation to be initiated, but the allotted time for the validation process elapsed before the validation process had completed. Note: You cannot add Read Only or faulty MDisks to a storage pool.

**User response:**

---

**CMMVC6300E** The create failed because the source and target VDisks are members of FlashCopy mappings that belong to different I/O groups.

**Explanation:** All FlashCopy mappings in a tree of connected mappings must be in the same I/O group. The new FlashCopy mapping that you attempted to create would have linked two existing trees that are in different I/O groups.

**User response:** You have three options. The first option is to resubmit the command and specify a different source or target volume. The second option is

to delete all of the existing mappings that contain the source volume and resubmit the command. The third option is to delete all of the existing mappings that contain the target volume and resubmit the command.

---

**CMMVC6301E The create failed because the specified consistency group does not exist.**

**Explanation:** The FlashCopy mapping was not created because the consistency group that you specified does not exist. You must create a consistency group before you can place a mapping in that group.

**User response:** Either create the FlashCopy consistency group that you specified and resubmit the command, or resubmit the command and specify an existing consistency group.

---

**CMMVC6302E The create failed because the resulting tree of FlashCopy mappings would exceed the upper limit.**

**Explanation:** Either the source volume or the target volume, or both, are already members of other FlashCopy mappings. The FlashCopy mapping was not created because the new FlashCopy mapping that you attempted to create would have linked two existing mapping trees into a single tree that exceeds the maximum number of mappings that are supported for a single tree.

**User response:** You have two options. The first option is to resubmit the command and specify a different source or target volume. The second option is to delete a sufficient number of the existing FlashCopy mappings in which either the source or the target volume is a member so that the combined mapping tree does not exceed the maximum number of mappings that are supported for a single tree, and resubmit the command.

---

**CMMVC6303E The create failed because the source and target VDisks are the same.**

**Explanation:** A particular volume cannot be both the source and the target in a FlashCopy mapping. The FlashCopy mapping was not created because you have specified the same volume as both the source and the target.

**User response:** Resubmit the command and specify source and target volumes that are not identical.

---

**CMMVC6304E The create failed because the source VDisk does not exist.**

**Explanation:** You must specify an existing volume as the source of a FlashCopy mapping. The FlashCopy mapping was not created because the source volume that you specified does not exist.

**User response:** Either create the source volume that

you specified and resubmit the command, or resubmit the command and specify an existing volume as the source.

---

**CMMVC6305E The create failed because the target VDisk does not exist.**

**Explanation:** You must specify an existing volume as the target of a FlashCopy mapping. The FlashCopy mapping was not created because the target volume that you specified does not exist.

**User response:** Either create the target volume that you specified and resubmit the command, or resubmit the command and specify an existing volume as the target.

---

**CMMVC6306E The create failed because the source VDisk is the member of a FlashCopy mapping whose grain size is different to that specified.**

**Explanation:** All FlashCopy mappings that are in a tree of connected mappings must have the same grain size. The FlashCopy mapping was not created because the source volume that you specified is either the source or the target volume of another FlashCopy mapping, and the grain size of the other mapping is different from the grain size that you specified for the mapping that you attempted to create.

**User response:** You have two options. The first option is to delete all of the FlashCopy mappings that contain the source volume that you specified where the grain size of the FlashCopy mapping is different from the grain size that you specified, and resubmit the command. The second option is to resubmit the command and do not specify the grain size attribute.

---

**CMMVC6307E The create failed because the target VDisk is the member of a FlashCopy mapping whose grain size is different to that specified.**

**Explanation:** All FlashCopy mappings that are in a tree of connected mappings must have the same grain size. The FlashCopy mapping was not created because the target volume that you specified is either the source or the target volume of another FlashCopy mapping, and the grain size of the other mapping is different from the grain size that you specified for the mapping that you attempted to create.

**User response:** You have two options. The first option is to delete all of the FlashCopy mappings that contain the target volume that you specified where the grain size of the FlashCopy mapping is different from the grain size that you specified, and resubmit the command. The second option is to resubmit the command and do not specify the grain size attribute.

---

**CMMVC6308E** The create failed because the source VDisk is the member of a FlashCopy mapping whose IO group is different to that specified.

**Explanation:** All FlashCopy mappings in a tree of connected mappings must be in the same I/O group. The FlashCopy mapping was not created because the source volume that you specified is the source or target volume in another FlashCopy mapping and the I/O group of the other FlashCopy mapping is different from the I/O group that you specified.

**User response:** You have two options. The first option is to delete all of the FlashCopy mappings that contain the source volume that you specified where the FlashCopy mapping is in a different I/O group from the I/O group that you specified, and resubmit the command. The second option is to resubmit the command and do not specify the I/O group attribute. If you perform the second option, the default value of the I/O group attribute is used.

---

**CMMVC6309E** The create failed because the target VDisk is the member of a FlashCopy mapping whose IO group is different to that specified.

**Explanation:** All FlashCopy mappings in a tree of connected mappings must be in the same I/O group. The FlashCopy mapping was not created because the target volume that you specified is the source or target volume in another FlashCopy mapping and the I/O group of the other FlashCopy mapping is different from the I/O group that you specified.

**User response:** You have two options. The first option is to delete all of the FlashCopy mappings that contain the target volume that you specified where the FlashCopy mapping is in a different I/O group from the I/O group that you specified, and resubmit the command. The second option is to resubmit the command and do not specify the I/O group attribute. If you perform the second option, the default value of the I/O group attribute is used.

---

**CMMVC6310E** The modify failed because the specified FlashCopy mapping does not exist.

**Explanation:** You cannot modify a FlashCopy mapping that does not exist. The modify command failed because the FlashCopy mapping that you specified does not exist.

**User response:** Resubmit the command and specify an existing FlashCopy mapping.

---

**CMMVC6311E** The command failed because the source VDisk is the target of a FlashCopy mapping that is in the specified consistency group.

**Explanation:** A particular volume cannot be both the source of one FlashCopy mapping and the target of another FlashCopy mapping in the same consistency group. The FlashCopy mapping was not created because the source volume of the FlashCopy mapping that you attempted to create is already the target volume of a FlashCopy mapping in the consistency group that you specified.

**User response:** Resubmit the command and specify a different consistency group.

---

**CMMVC6312E** The command failed because the target VDisk is the source of a FlashCopy mapping that is in the specified consistency group.

**Explanation:** A particular volume cannot be both the source of one FlashCopy mapping and the target of another FlashCopy mapping in the same consistency group. The FlashCopy mapping was not created because the target volume of the FlashCopy mapping that you attempted to create is already the source volume of a FlashCopy mapping in the consistency group that you specified.

**User response:** Resubmit the command and specify a different consistency group.

---

**CMMVC6313E** The command failed because the specified background copy rate is invalid.

**Explanation:** The command failed because the background copy rate that you specified is not a supported value.

**User response:** Either resubmit the command and specify a supported value for the background copy rate, or resubmit the command and do not specify the background copy rate attribute. If you do not specify the background copy rate attribute, the default background copy rate value is used.

---

**CMMVC6314E** The command failed because the specified cleaning rate is not valid.

**Explanation:** The command failed because the cleaning rate that you specified is not a supported value.

**User response:** Either resubmit the command and specify a supported value for the cleaning rate, or resubmit the command and do not specify the cleaning rate attribute. If you do not specify the cleaning rate attribute, the default cleaning rate value is used.



---

**CMMVC6315E The command failed because the specified grain size is not valid.**

**Explanation:** The command failed because the grain size that you specified is not a supported value.

**User response:** Either resubmit the command and specify a supported value for the grain size, or resubmit the command and do not specify the grain size attribute. If you do not specify the grain size attribute, the default grain size value is used.

---

**CMMVC6319E The command has failed because a combination of IPv4 and IPv6 parameters were entered.**

**Explanation:** The task accepts either IPv4 or IPv6 parameters. You cannot specify a combination of IPv4 and IPv6 parameters for this task.

**User response:** Specify only IPv4 or only IPv6 parameters, and resubmit the task.

---

**CMMVC6320E The command has failed because the IPv4 address is not valid.**

**Explanation:** The valid IPv4 address format is d.d.d.d, where d is a decimal value from 0-255.

**User response:** Specify a valid IPv4 address, and resubmit the task.

---

**CMMVC6321E The command has failed because the IPv4 subnet mask is not valid.**

**Explanation:** The valid IPv4 address format is d.d.d.d, where d is a decimal value from 0-255.

**User response:** Specify a valid IPv4 subnet mask, and resubmit the task.

---

**CMMVC6322E The command has failed because the IPv4 gateway address is not valid.**

**Explanation:** The valid IPv4 address format is d.d.d.d, where d is a decimal value from 0-255.

**User response:** Specify a valid IPv4 gateway address, and resubmit the task.

---

**CMMVC6323E The command has failed because the IPv6 address is not valid.**

**Explanation:** Valid IPv6 address formats are:

- x:x:x:x:x:x:x
- x:x:x:x:x:d.d.d.d

where d is a decimal value from 0-255 of an IPv4 address and x is a hexadecimal value of an IPv6 address.

---

A special syntax is available to compress long strings of zero bits. The use of '::' indicates multiple groups of zeros. The ':' can appear only once in an address. The '::' can also be used to compress the leading or trailing zeros in an address.

- Example: 123.123.123.123
- Example: 1080:0:0:0:8:800:200C:417A, which can be compressed to 1080::8:800:200C:417A
- Example: 0:0:0:0:FFFF:129.144.52.38, which can be compressed to ::FFFF:129.144.52.38
- Example: 0:0:0:0:0:13.1.68.3, which can be compressed to ::13.1.68.3

**User response:** Specify a valid IPv6 address, and resubmit the task.

---

**CMMVC6324E The command has failed because the IPv6 prefix is not valid.**

**Explanation:** The value that you entered for an IPv6 address prefix is not a valid IPv6 address prefix.

**User response:** Specify a valid IPv6 address prefix, and resubmit the task.

---

**CMMVC6325E The command has failed because the IPv6 gateway address is not valid.**

**Explanation:** Valid IPv6 address formats are:

- x:x:x:x:x:x:x
- x:x:x:x:x:d.d.d.d

where d is a decimal value from 0-255 of an IPv4 address and x is a hexadecimal value of an IPv6 address.

---

A special syntax is available to compress long strings of zero bits. The use of '::' indicates multiple groups of zeros. The ':' can appear only once in an address. The '::' can also be used to compress the leading or trailing zeros in an address.

- Example: 123.123.123.123
- Example: 1080:0:0:0:8:800:200C:417A, which can be compressed to 1080::8:800:200C:417A
- Example: 0:0:0:0:FFFF:129.144.52.38, which can be compressed to ::FFFF:129.144.52.38
- Example: 0:0:0:0:0:13.1.68.3, which can be compressed to ::13.1.68.3

**User response:** Specify a valid IPv6 gateway address, and resubmit the task.

---

**CMMVC6326E The command has failed because the IPv4 service state address is not valid.**

**Explanation:** The valid IPv4 address format is d.d.d.d, where d is a decimal value from 0-255.

**User response:** Specify a valid IPv4 service state address, and resubmit the task.

---

---

**CMMVC6327E** The command has failed because the IPv6 service state address is not valid.

**Explanation:** Valid IPv6 address formats are:

- x:x:x:x:x:x:x
- x:x:x:x:x:d.d.d.d

where d is a decimal value from 0-255 of an IPv4 address and x is a hexadecimal value of an IPv6 address.

A special syntax is available to compress long strings of zero bits. The use of '::' indicates multiple groups of zeros. The ':' can appear only once in an address. The '::' can also be used to compress the leading or trailing zeros in an address.

- Example: 123.123.123.123
- Example: 1080:0:0:0:8:800:200C:417A, which can be compressed to 1080::8:800:200C:417A
- Example: 0:0:0:0:FFFF:129.144.52.38, which can be compressed to ::FFFF:129.144.52.38
- Example: 0:0:0:0:0:13.1.68.3, which can be compressed to ::13.1.68.3

**User response:** Specify a valid IPv6 service state address, and resubmit the task.

---

**CMMVC6328E** The command has failed because the console address is not valid.

**Explanation:** The valid IPv4 address format is d.d.d.d, where d is a decimal value from 0-255.

Valid IPv6 address formats are:

- x:x:x:x:x:x:x
- x:x:x:x:x:d.d.d.d

where d is a decimal value from 0-255 of an IPv4 address and x is a hexadecimal value of an IPv6 address.

A special syntax is available to compress long strings of zero bits. The use of '::' indicates multiple groups of zeros. The ':' can appear only once in an address. The '::' can also be used to compress the leading or trailing zeros in an address.

- Example: 123.123.123.123
- Example: 1080:0:0:0:8:800:200C:417A, which can be compressed to 1080::8:800:200C:417A
- Example: 0:0:0:0:FFFF:129.144.52.38, which can be compressed to ::FFFF:129.144.52.38
- Example: 0:0:0:0:0:13.1.68.3, which can be compressed to ::13.1.68.3

**User response:** Specify a valid console address, and resubmit the task.

---

**CMMVC6329E** The command has failed because the IP address is not valid.

**Explanation:** The valid IPv4 address format is d.d.d.d, where d is a decimal value from 0-255.

Valid IPv6 address formats are:

- x:x:x:x:x:x:x
- x:x:x:x:x:d.d.d.d

where d is a decimal value from 0-255 of an IPv4 address and x is a hexadecimal value of an IPv6 address.

A special syntax is available to compress long strings of zero bits. The use of '::' indicates multiple groups of zeros. The ':' can appear only once in an address. The '::' can also be used to compress the leading or trailing zeros in an address.

- Example: 123.123.123.123
- Example: 1080:0:0:0:8:800:200C:417A, which can be compressed to 1080::8:800:200C:417A
- Example: 0:0:0:0:FFFF:129.144.52.38, which can be compressed to ::FFFF:129.144.52.38
- Example: 0:0:0:0:0:13.1.68.3, which can be compressed to ::13.1.68.3

**User response:** Specify a valid IP address, and resubmit the task.

---

**CMMVC6330E** The command has failed because an IPv6 address was specified and the cluster does not have an IPv6 address.

**Explanation:** The cluster can only communicate with a server through an IPv6 address if an IPv6 cluster management IP address is configured.

**User response:** Either configure the cluster to have an IPv6 cluster management address or specify an IPv4 address, and resubmit the task.

**Note:** You do not need to remove the IPv4 address if you configure the cluster to have an IPv6 cluster management address.

---

**CMMVC6331E** The command has failed because an IPv4 address was specified and the cluster does not have an IPv4 address.

**Explanation:** The cluster can only communicate with a server through an IPv4 address if an IPv4 cluster management IP address is configured.

**User response:** Either configure the cluster to have an IPv4 cluster management address or specify an IPv6 address, and resubmit the task.

**Note:** You do not need to remove the IPv6 address if you configure the cluster to have an IPv4 cluster management address.

---

**CMMVC6332E** The command has failed because an IPv6 email server address was specified and the cluster does not have an IPv6 address.

**Explanation:** The cluster can only communicate with a server through an IPv6 address if an IPv6 cluster management IP address is configured.

**User response:** Either configure the cluster to have an IPv6 cluster management address or use an email server that has an IPv4 address, and resubmit the task.

**Note:** You do not need to remove the IPv4 address if you configure the cluster to have an IPv6 cluster management address.

---

**CMMVC6333E** The command has failed because an IPv4 email server address was specified and the cluster does not have an IPv4 address.

**Explanation:** The cluster can only communicate with a server through an IPv4 address if an IPv4 cluster management IP address is configured.

**User response:** Either configure the cluster to have an IPv4 cluster management address or use an email server that has an IPv6 address, and resubmit the task.

**Note:** You do not need to remove the IPv6 address if you configure the cluster to have an IPv4 cluster management address.

---

**CMMVC6334E** The command failed as the email port number supplied is invalid.

**Explanation:** The value that you entered for an email port number is not a valid email port number.

**User response:** Specify a valid email port number, and resubmit the task.

---

**CMMVC6335E** The command failed as the combination of parameters provided are either mutually incompatible or would leave the cluster without a functioning protocol stack.

**Explanation:** You have submitted a task with a combination of parameters and parameter values that is not supported or that does not provide the minimum amount of required information.

**User response:** Ensure that you specify a supported combination of parameters and parameter values, and resubmit the task.

---

**CMMVC6336E** The virtual disk (VDisk) copy was not created because the grain size must be 32, 64, 128 or 256.

**Explanation:** You have supplied an incorrect value for the -grainsize parameter when you attempted to create a thin-provisioned volume copy.

**User response:** Specify a supported grain size, and resubmit the command.

---

**CMMVC6337E** The action failed because the warning size must be a multiple of 512 bytes.

**Explanation:** You are attempting to create a thin-provisioned volume copy but you have entered an incorrect value for the -warning parameter. The value can either be a percentage of the volume capacity or an absolute value that is a multiple of 512 bytes.

**User response:** Enter a supported warning value, and resubmit the command.

---

**CMMVC6338E** The action failed because the warning size can not be larger than the virtual size.

**Explanation:** You are attempting to create a thin-provisioned volume copy but you have entered an incorrect value for the -warning parameter. The warning value cannot be greater than the volume capacity.

**User response:** Enter a supported warning value, and resubmit the command.

---

**CMMVC6339E** The virtual disk (VDisk) copy was not created because the virtual size was not provided.

**Explanation:** You are attempting to create an image-mode thin-provisioned volume but you did not set the -size parameter.

**User response:** Resubmit the command using the -size parameter.

---

**CMMVC6340E** The action failed because the value supplied for real size is not a multiple of 512 bytes.

**Explanation:** You are attempting to create or resize a thin-provisioned volume copy but you have entered an incorrect value for the -rszie parameter. All sizes must be integer multiples of 512 bytes.

**User response:** Resubmit the command using a supported -rszie parameter value.

---

---

**CMMVC6341E** The action failed because the virtual disk (VDisk) copy is not space-efficient.

**Explanation:** You are attempting to run a command that is valid only for thin-provisioned volumes on a volume that is not thin-provisioned.

**User response:** Specify a thin-provisioned volume, and resubmit the command.

---

**CMMVC6342E** The virtual disk (VDisk) copy was not shrunk because its real size cannot be less than its used size.

**Explanation:** You are attempting to reduce the real size that is allocated to a thin-provisioned volume copy, but the command cannot be initiated because it would make the real size less than the size that is currently used.

**User response:** Determine the used size of the volume copy, and resubmit the command using a `-rsize` parameter value that is greater than or equal to the used size.

---

**CMMVC6343E** The virtual disk (VDisk) copy was not shrunk because its real size can not be negative.

**Explanation:** You are attempting to reduce the real size that is allocated to a thin-provisioned volume copy, but the command cannot be initiated because it would make the real size less than zero.

**User response:** Determine the real size of the volume copy, and resubmit the command using a supported `-rsize` parameter value.

---

**CMMVC6344E** The repair operation cannot start because the space-efficient virtual disk (VDisk) copy is already being repaired.

**Explanation:** You are attempting to repair a thin-provisioned volume copy, but the copy is already being repaired.

**User response:** Specify the correct volume and copy parameters, and resubmit the command.

---

**CMMVC6345E** The repair operation cannot start because the space-efficient virtual disk (VDisk) copy was created using `-import` but the cluster could not recognize its format.

**Explanation:** You are attempting to repair a thin-provisioned volume copy that is reporting corrupt metadata. The cluster cannot repair the volume copy because it was not recognized as a valid thin-provisioned volume when it was imported into this cluster. The most probable cause is that the wrong MDisk was used when the volume copy was imported.

**User response:** Delete the volume copy, and resubmit the import operation using the same MDisk that was exported from the original cluster.

---

**CMMVC6346E** The repair operation cannot start because the space-efficient virtual disk (VDisk) copy was created using `-import` with a real size that is too small.

**Explanation:** You are attempting to repair a thin-provisioned volume copy that is reporting corrupt metadata. The cluster cannot repair the volume copy because although it was recognized as a valid thin-provisioned volume when it was imported into this cluster, the real size allocated to the volume copy is too small. The most probable cause is that the incorrect value was supplied with `-rsize` parameter when the volume copy was imported.

**User response:** Delete the volume copy. Resubmit the import operation either using a larger value for `-rsize`, or supplying the `-rsize` parameter without a value to let the system choose a real size.

---

**CMMVC6347E** The specific upgrade package cannot be installed on this hardware level.

**Explanation:** The version of software that you are attempting to install does not support the hardware level of the configuration node.

**User response:** Check the release notes for the version of software that you want to install. Ensure that the version of software that you install supports the hardware level of all of the nodes in the cluster, and resubmit the task.

---

**CMMVC6348E** The command failed as there was not enough information provided to process successfully.

**Explanation:** You have submitted a task with a combination of parameters and parameter values that does not provide the minimum amount of required information.

**User response:** Ensure that you specify a supported combination of parameters and parameter values, and resubmit the task.

---

**CMMVC6349E** The command was not initiated because the VDisk cache has been lost and you have not specified the `-force` option.

**Explanation:** You must specify the `-force` option when you move a volume from one I/O group to another and the volume has lost cache data.

**User response:** Resubmit the command and specify the `-force` option.

---

**CMMVC6350E The command failed because there is insufficient mirror bitmap space.**

**Explanation:** The command failed because there is insufficient free memory to allocate the bitmap needed for volume mirroring in the I/O group.

**User response:** Perform one of the following actions:

- Submit a **chiogrp** command to increase the bitmap space.
- Remove volume mirrors from the I/O group.

Resubmit the command that caused this error.

---

**CMMVC6351E The command failed because the virtual disk (VDisk) is not mirrored.**

**Explanation:** Only mirrored volumes are supported for this command.

**User response:** Perform one of the following actions:

- Submit the appropriate command for a volume that is not mirrored.
  - Submit a **addvdiskcopy** command to add a copy to the volume, and resubmit the command that caused this error.
- 

**CMMVC6352E The command failed because the number of copies of this virtual disk (VDisk) would exceed the limit.**

**Explanation:** You cannot exceed the limit on the number of copies that are supported for a volume.

**User response:** Submit a **rmvdiskcopy** or **splitvdiskcopy** command to decrease the number of volume copies, and resubmit the command that caused this error.

---

**CMMVC6353E The command failed because the copy specified does not exist.**

**Explanation:** You must specify an existing copy for this command.

**User response:** Submit an **lsvdiskcopy** command to show all of the available copies for this volume. Select a copy that exists, and then resubmit the command that caused this error.

---

**CMMVC6354E The command failed because a copy is not synchronized.**

**Explanation:** The copy that you specify for this command must be a synchronized copy.

**User response:** Use the **lsvdisksyncprogress** command to view the synchronization status. Wait for the copy to synchronize. If you want the synchronization process to complete more quickly, increase the rate by submitting a **chvdisk** command.

---

When the copy is synchronized, resubmit the command that caused this error.

---

**CMMVC6355E The command failed because an image mode copy is not synchronized and -force was not specified.**

**Explanation:** When you specify an image mode copy for this command, the copy must be synchronized unless you also specify the **-force** parameter.

**User response:** Perform one of the following actions:

- Use the **lsvdisksyncprogress** command to view the synchronization status. Wait for the copy to synchronize. If you want the synchronization process to complete more quickly, increase the rate by submitting a **chvdisk** command. When the copy is synchronized, resubmit the command that caused this error.
- Resubmit the command and specify the **-force** parameter.

**Note:** When you specify the **-force** parameter with the command that caused this error, the image mode copy is no longer guaranteed to have the correct volume data.

---

**CMMVC6356E The command failed because a copy is not synchronized and -force was not specified.**

**Explanation:** When you specify a copy for this command, the copy must be synchronized unless you also specify the **-force** parameter.

**User response:** Perform one of the following actions:

- Use the **lsvdisksyncprogress** command to view the synchronization status. Wait for the copy to synchronize. If you want the synchronization process to complete more quickly, increase the rate by submitting a **chvdisk** command. When the copy is synchronized, resubmit the command that caused this error.
- Resubmit the command and specify the **-force** parameter.

**Note:** When you specify the **-force** parameter with the command that caused this error, the entire volume copy is resynchronized.

---

**CMMVC6357E The command failed because the copy specified is not synchronized and -force was not specified.**

**Explanation:** When you specify a copy for this command, the copy must be synchronized unless you also specify the **-force** parameter.

**User response:** Perform one of the following actions:

- Use the **lsvdisksyncprogress** command to view the synchronization status. Wait for the copy to

synchronize. If you want the synchronization process to complete more quickly, increase the rate by submitting a **chvdisk** command. When the copy is synchronized, resubmit the command that caused this error.

- Resubmit the command and specify the **-force** parameter.

**Note:** When you specify the **-force** parameter with the command that caused this error, the created volume is no longer guaranteed to have identical data to the original volume when the split is performed.

---

**CMMVC6358E The command failed because the copy specified is the only synchronized copy.**

**Explanation:** The command failed because the copy specified is the only synchronized copy.

**User response:** Use the **lsvdisksyncprogress** command to view the synchronization status. Wait for another copy to synchronize. If you want the synchronization process to complete more quickly, increase the rate by submitting a **chvdisk** command. When the copy has synchronized, resubmit the command that caused this error.

---

**CMMVC6359E The command failed because there are insufficient online synchronized copies.**

**Explanation:** This error occurs when at least one of the volume copies is offline.

**User response:** Fix all of the errors that are associated with the volume copies, and resubmit the command.

---

**CMMVC6363E The command failed because the Logical Block Address (LBA) specified is invalid for this virtual disk (VDisk).**

**Explanation:** You must specify a Logical Block Address (LBA) that is a valid address for this volume.

**User response:** Use the **lsvdisk** command to obtain the volume size, and resubmit the command that caused this error using a logical block address that is in range.

---

**CMMVC6364E The command failed because the logical block address (LBA) requested is too large for the disk.**

**Explanation:** You have specified an LBA in conjunction with a volume or MDisk, but the LBA is too large and does not exist on the disk.

**User response:** Check the size of the disk, and resubmit the command using an LBA that exists on the disk.

---

**CMMVC6365E The command timed out.**

**Explanation:** The command has not completed in a reasonable amount of time. Processing of the command required the software to wait for a set of MDisk reads or writes to complete, and the predefined reasonable wait time has been exceeded.

**User response:** Resolve any MDisk or fabric event log entries, and resubmit the command.

---

**CMMVC6366E One or more nodes in the cluster has hardware that is not supported by the new software package.**

**Explanation:** The version of software that you are attempting to install does not support the hardware in at least one node in the cluster.

**User response:** Check the release notes for the version of software that you want to install. Upgrade hardware so that all of the hardware in the cluster is supported by the new version of software, and resubmit the task.

---

**CMMVC6367E A remote cluster is running software that is incompatible with the new software package.**

**Explanation:** The version of software that you are attempting to install on the local cluster does not support the version of software that is installed on the remote cluster.

**User response:** Check the release notes for the version of software that you want to install. Perform one of the following actions:

- Upgrade the software on the remote cluster to a version that is supported by the version of software that you want to install on the local cluster before you upgrade the software on the local cluster.
- Delete the cluster partnership to stop all remote copy relationships between the clusters, and resubmit the task.

---

**CMMVC6368E The new software package might be incompatible with the remote cluster.**

**Explanation:** The software version compatibility between clusters cannot be checked because the remote cluster is not accessible.

**User response:** Perform one of the following actions:

- Ensure that the link to the remote cluster is functioning properly, and resubmit the task.
- Delete the cluster partnership to stop all remote copy relationships between the clusters, and resubmit the task.

---

**CMMVC6369W** The FlashCopy storage capacity that the cluster is using is approaching the FlashCopy storage capacity that is licensed.

**Explanation:** You are being warned that the FlashCopy storage capacity license might be exceeded soon.

**User response:** Upgrade the FlashCopy storage capacity license to prevent recurrence of this warning message.

---

**CMMVC6370W** The Remote Copy storage capacity that the cluster is using is approaching the Remote Copy storage capacity that is licensed.

**Explanation:** You are being warned that the Remote Copy storage capacity license might be exceeded soon.

**User response:** Upgrade the Remote Copy storage capacity license to prevent recurrence of this warning message.

---

**CMMVC6372W** The virtualized storage capacity that the cluster is using is approaching the virtualized storage capacity that is licensed.

**Explanation:** You are being warned that the virtualized storage capacity license might be exceeded soon.

**User response:** Upgrade the virtualized storage capacity license to prevent recurrence of this warning message.

---

**CMMVC6373W** The virtualized storage capacity that the cluster is using exceeds the virtualized storage capacity that is licensed.

**Explanation:** You are being warned that the virtualized storage capacity license has been exceeded.

**User response:** Upgrade the virtualized storage capacity license to prevent recurrence of this warning message.

---

**CMMVC6374W** The FlashCopy storage capacity that the cluster is using exceeds the FlashCopy storage capacity that is licensed.

**Explanation:** You are being warned that the FlashCopy storage capacity license has been exceeded.

**User response:** Upgrade the FlashCopy storage capacity license to prevent recurrence of this warning message.

---

**CMMVC6375W** The Remote Copy storage capacity that the cluster is using exceeds the Remote Copy storage capacity that is licensed.

**Explanation:** You are being warned that the Remote Copy storage capacity license has been exceeded.

**User response:** Upgrade the Remote Copy storage capacity license to prevent recurrence of this warning message.

---

**CMMVC6394E** The command failed because an attempt to make the virtual disk cache empty took too long.

**Explanation:** The failed command must empty the volume cache before attempting the requested action to ensure that data is preserved. The empty volume cache subtask has taken too long, and therefore the command that you have submitted was not initiated so that other configuration activity can occur.

The system continues attempting to empty the volume cache.

The storage associated with the volume is probably overloaded.

**User response:** Wait a few minutes to allow the volume cache to empty. Resubmit the command.

Alternatively, you can use the `-force` parameter, if the command supports the `-force` parameter, to bypass the empty volume cache subtask. However, specifying the `-force` parameter will discard cache data for the volume. Only use the `-force` flag with this command if you do not intend to use the existing contents of the volume.

In addition to the above actions, investigate the performance of the network storage devices associated with this volume. The performance of host applications using these devices might be degraded.

Remedial action to resolve a performance problem enables host application performance to return to optimal conditions, and prevents this error message from recurring when you resubmit the command that caused this error.

---

**CMMVC6399E** The command failed because there is not enough memory available for reservation.

**Explanation:** At least one node in the cluster cannot reserve the required amount of memory. This might be caused by pinned data in the cache.

**User response:** Check for events in the event log. Follow the fix procedures to resolve the problem.

---

**CMMVC6400E** The command failed because a specified managed disk (MDisk) is already in use.

**Explanation:** You cannot specify an MDisk for this command if it is already in a storage pool or is being used as an image mode volume.

**User response:** Specify an MDisk that is not being used as an image mode volume and is not in a storage pool, and resubmit the command.

---

**CMMVC6401E** The command failed because one or more of the specified managed disks (MDisks) that you have specified are not in the required managed disk group.

**Explanation:** The command requires that all of the MDisks that you specify must be in the same storage pool.

**User response:** Ensure that all of the MDisks that you specify are in the same storage pool, and resubmit the command.

---

**CMMVC6402E** The command failed because the managed disk (MDisk) is not in the required managed disk group.

**Explanation:** All of the MDisks that you specify must be in the required storage pool. At least one of the source MDisks that you have specified in the command is not in the required storage pool.

**User response:** Ensure that all of the MDisks that you specify are in the storage pool that you specify, and resubmit the command.

---

**CMMVC6403E** The command failed because the target managed disk (MDisk) is not in the required managed disk group.

**Explanation:** All of the MDisks that you specify must be in the required storage pool. At least one of the target MDisks that you have specified in the command is not in the required storage pool.

**User response:** Ensure that all of the MDisks that you specify are in the storage pool that you specify, and resubmit the command.

---

**CMMVC6404E** The command failed because the source and target managed disk groups must be different.

**Explanation:** The source and target storage pools that you specify for a cross storage pool migration must be different.

**User response:** Ensure that the source and target storage pools that you specify for a cross storage pool migration are different, and resubmit the command.

---

**CMMVC6405E** The command failed because the target copy was not specified.

**Explanation:** A target copy must be specified when you use migrations on a volume and more than one volume copy exists.

**User response:** Specify the target copy, and resubmit the command.

---

**CMMVC6406E** The command failed because the specified managed disk group does not exist.

**Explanation:** At least one of the storage pools that you have specified in the parameter list does not exist.

**User response:** Ensure that each of the storage pools that you specify exists, and resubmit the command.

---

**CMMVC6407E** The command failed because the managed disk group is invalid.

**Explanation:** At least one storage pool ID is above the maximum value that is available for the system.

**User response:** Ensure that each storage pool ID that you specify in the parameter list exists, and resubmit the command.

---

**CMMVC6408E** The command failed because too few managed disk groups were specified.

**Explanation:** You must specify the number of storage pools that is consistent with the other parameters and parameter values that you specify with the command.

**User response:** Refer to the command documentation for valid combinations of parameters and parameter values. Use a valid combination of parameters and values, and resubmit the command.

---

**CMMVC6409E** The command failed because too many managed disk groups were specified.

**Explanation:** You must specify the number of storage pools that is consistent with the other parameters and parameter values that you specify with the command.

**User response:** Refer to the command documentation for valid combinations of parameters and parameter values. Use a valid combination of parameters and values, and resubmit the command.

---

**CMMVC6410E** The command failed because too few managed disks (MDisks) were specified.

**Explanation:** You must specify the number of MDisks that is consistent with the other parameters and parameter values that you specify with the command.

**User response:** Refer to the command documentation



for valid combinations of parameters and parameter values. Use a valid combination of parameters and values, and resubmit the command.

---

**CMMVC6411E** The command failed because too many managed disks (MDisks) were specified.

**Explanation:** You must specify the number of MDisks that is consistent with the other parameters and parameter values that you specify with the command.

**User response:** Refer to the command documentation for valid combinations of parameters and parameter values. Use a valid combination of parameters and values, and resubmit the command.

---

**CMMVC6412E** The command failed because the managed disk group extent size is above maximum permitted size.

**Explanation:** You cannot specify a storage pools extent size that is larger the maximum size.

**User response:** Specify a storage pool extent size that is less than or equal to the maximum size, and resubmit the command.

---

**CMMVC6413E** The command failed because the managed disk (MDisk) is invalid.

**Explanation:** At least one MDisk ID is above the maximum value that is available for the system.

**User response:** Ensure that each MDisk ID that you specify in the parameter list exists, and resubmit the command.

---

**CMMVC6414E** The command failed because the managed disk (MDisk) is currently being migrated.

**Explanation:** When you submit this command, you cannot specify an MDisk that is being migrated.

**User response:** Either wait until the migration has completed for the MDisk that you specify, or specify a different MDisk, and resubmit the command.

---

**CMMVC6415E** The command failed because the managed disk group warning threshold is too low.

**Explanation:** You must specify a storage pool warning threshold that is equal to or greater than the minimum size.

**User response:** Specify a storage pool warning threshold that is equal to or greater than the minimum size, and resubmit the command.

---

**CMMVC6416E** The command failed because the managed disk group warning threshold is too high.

**Explanation:** You must specify a storage pool warning threshold size that is equal to or less than the size of the storage pool when all of the MDisks have been added, or you must specify a storage pool warning percentage that is equal to or less than the maximum warning threshold percentage.

**User response:** Specify valid values for the storage pool warning threshold size or percentage, and resubmit the command.

---

**CMMVC6417E** The command failed because the managed disk group warning threshold is invalid.

**Explanation:** To specify the warning threshold there must be at least one managed MDisk in the storage pool.

**User response:** Ensure that there is at least one MDisk defined for the storage pool or remove the warning threshold, and resubmit the command.

---

**CMMVC6418E** The command failed because the virtual disk (VDisk) is in the process of being resized.

**Explanation:** When you submit this command, you cannot specify a volume that is being resized.

**User response:** Wait for the resize volume operation to complete. If you still want to submit this command after the operation has completed, resubmit the command.

---

**CMMVC6419E** The command failed because one or more of the specified managed disks (MDisks) are in the process of being deleted.

**Explanation:** When you submit this command, you cannot specify an MDisk that is being deleted with the -force option.

**User response:** Wait for the delete MDisk operation to complete. Do not include any MDisks that have been deleted in the list of MDisks that you specify, and resubmit the command.

---

**CMMVC6423E** The Send Inventory email operation failed because email is not started.

**Explanation:** The send inventory email functionality has been enabled but the email service has not been started.

**User response:** Disable the send inventory email functionality or start the email service.

---

**CMMVC6424E** The Send Inventory email operation failed because there are no inventory email users.

**Explanation:** The send inventory functionality has been enabled but no email users with the ability to receive inventory emails have been created.

**User response:** Either turn off the send inventory email functionality or create an email user account that is capable of receiving inventory emails. Refer to the documentation for the mke-mailuser command for help on creating email users.

---

**CMMVC6425E** The action failed because the maximum number of objects has been reached.

**Explanation:** The action failed because the maximum number of objects has been reached.

**User response:** Not applicable.

---

**CMMVC6426E** The command failed because a specified managed disk (MDisk) is already in use.

**Explanation:** You cannot specify an MDisk that is already configured as an image mode volume.

**User response:** Specify an unmanaged disk, and resubmit the task.

---

**CMMVC6427E** The command failed because one or more of the specified managed disks (MDisks) are not in the required managed disk group.

**Explanation:** The create volume task requires that all of the MDisks that you specify must be in the same storage pool.

**User response:** Ensure that all of the MDisks that you specify are in the same storage pool, and resubmit the task.

---

**CMMVC6428E** The command failed because the source managed disk (MDisk) is not in the required managed disk group.

**Explanation:** The task requires that all of the source MDisks that you specify must be in the same storage pool.

**User response:** Ensure that all of the source MDisks that you specify are in the same storage pool, and resubmit the task.

---

**CMMVC6429E** The command failed because the target managed disk (MDisk) is not in the required managed disk group.

**Explanation:** The task requires that all of the target MDisks that you specify must be in the same storage pool.

**User response:** Ensure that all of the target MDisks that you specify are in the same storage pool, and resubmit the task.

---

**CMMVC6430E** The command failed because the target and source managed disk groups must be different.

**Explanation:** The cross storage pool migration task does not support specifying the same storage pool to be both the source and target storage pool.

**User response:** Specify a source storage pool and a target storage pool that are not identical, and resubmit the task.

---

**CMMVC6431E** The command failed because the target copy was not specified.

**Explanation:** When you use migrations on a volume and there is more than one copy, you must specify which copy to use as the target copy.

**User response:** Specify the target copy, and resubmit the task.

---

**CMMVC6432E** The command failed because the specified managed disk group does not exist.

**Explanation:** All of the storage pools that you specify must already exist.

**User response:** Ensure that all of the storage pools that you specify already exist, and resubmit the task.

---

**CMMVC6433E** The command failed because the managed disk group is invalid.

**Explanation:** All of the storage pool IDs that you specify must have a value that is less than or equal to the maximum supported storage pool ID value.

**User response:** Ensure that all storage pools have supported ID values. Ensure that all of the storage pools that you specify already exist, and resubmit the task.

---

**CMMVC6434E** The command failed because too few managed disk groups were specified.

**Explanation:** The combination of parameters and parameter values that you have specified is not supported. The task requires that you specify more storage pools than the number that you have specified.

**User response:** Specify a supported combination of parameters and parameter values, and resubmit the task.

---

**CMMVC6435E** The command failed because too many managed disk groups were specified.

**Explanation:** The combination of parameters and parameter values that you have specified is not supported. The task requires that you specify fewer storage pools than the number that you have specified.

**User response:** Specify a supported combination of parameters and parameter values, and resubmit the task.

---

**CMMVC6436E** The command failed because too few managed disks (MDisks) were specified.

**Explanation:** The combination of parameters and parameter values that you have specified is not supported. The task requires that you specify more MDisks than the number that you have specified.

**User response:** Specify a supported combination of parameters and parameter values, and resubmit the task.

---

**CMMVC6437E** The command failed because too many managed disks (MDisks) were specified.

**Explanation:** The combination of parameters and parameter values that you have specified is not supported. The task requires that you specify fewer MDisks than the number that you have specified.

**User response:** Specify a supported combination of parameters and parameter values, and resubmit the task.

---

**CMMVC6438E** The command failed because the managed disk group extent size is above maximum permitted size.

**Explanation:** The storage pool extent size that you have specified is greater than the supported maximum value.

**User response:** Specify a supported storage pool extent size, and resubmit the task.

---

**CMMVC6439E** The command failed because the managed disk (MDisk) is invalid.

**Explanation:** Each MDisk ID must have a value that is less than or equal to the maximum supported MDisk ID value.

**User response:** Ensure that all of the MDisks have supported ID values. Ensure that all of the MDisks that you specify already exist, and resubmit the task.

---

**CMMVC6440E** The command failed because the managed disk (MDisk) is currently being migrated.

**Explanation:** When you submit this task, you cannot specify an MDisk that is being migrated.

**User response:** Ensure that the MDisk that you specify is not migrating, and resubmit the task. If you want to specify the same MDisk and resubmit the task, ensure that the migration for that MDisk has completed before you resubmit the task.

---

**CMMVC6441E** The command failed because the managed disk group warning threshold is too low.

**Explanation:** The value that you have specified for the storage pool warning threshold is less than the minimum supported value.

**User response:** Specify a supported value for the storage pool warning threshold, and resubmit the task.

---

**CMMVC6442E** The command failed because the managed disk group warning threshold is too high.

**Explanation:** Either the value for the storage pool warning percentage is greater than the maximum supported value, or the storage pool warning disk size is greater than the storage pool capacity.

**User response:** Specify supported values for storage pool warning percentage and disk size, and resubmit the task.

---

**CMMVC6443E** The command failed because the managed disk group warning threshold is invalid.

**Explanation:** If you submit this command and specify a storage pool warning threshold percentage, you must specify a storage pool that contains at least one MDisk and you must specify a supported value for the storage pool warning threshold percentage.

**User response:** Either do not specify a storage pool warning threshold percentage, or specify a supported value for the storage pool warning threshold percentage and specify a storage pool that contains at least one MDisk, and resubmit the task.

---

**CMMVC6444E** The command failed because the virtual disk (VDisk) is in the process of being resized.

**Explanation:** You cannot specify a volume that is being resized when you submit this task.

**User response:** Wait for the resize volume task to complete. You can specify the same volume and resubmit this task only after the resize volume task that

is in progress has completed.

---

**CMMVC6445E** The command failed because one or more of the specified managed disks (MDisks) are in the process of being deleted.

**Explanation:** You cannot specify an MDisk that is being force deleted.

**User response:** Wait until all force delete MDisk tasks have completed. Ensure that all of the MDisks that you specify still exist, and resubmit the task.

---

**CMMVC6446E** The command failed because the managed disk groups have different extent sizes.

**Explanation:** This task requires that the extent size of the source storage pool and the extent size of the target storage pool must be identical.

**User response:** If you want to resubmit this command, ensure that the source and target storage pools have the same extent size. If you want to move a volume to a storage pool that has a different extent size, you must use the procedure that is documented in the technical notes.

---

**CMMVC6447E** The command failed because the virtual disk (VDisk) is currently being migrated.

**Explanation:** You cannot specify a volume that is being migrated.

**User response:** Either wait until the volume migration process has completed and resubmit the task, or specify a volume that is not being migrated and resubmit the task.

---

**CMMVC6448E** Deleting this node will cause data loss for resources associated with the I/O group of this node.

**Explanation:** This node contains resources which are vital to the I/O group and unavailable elsewhere. Removing this node will cause a loss of customer data.

It is recommended that this node not be removed unless the customer data supported by it is of no consequence.

**User response:** The -force option must be used to remove this node.

---

**CMMVC6449E** The operation was not performed because the partnership owns Global or Metro Mirror relationships or consistency groups.

**Explanation:** The cluster partnership cannot be removed while there are Global or Metro Mirror

relationships or consistency groups that are configured in the local cluster and that are associated with the remote cluster of the partnership.

**User response:** Identify all of the Global or Metro Mirror relationships or consistency groups in the local cluster that are configured between this cluster and the remote cluster of the partnership. Remove all of the relationships and groups that you have identified, and resubmit the task.

**Note:** Do not remove relationships or groups that are associated with a different cluster, and do not remove relationships or groups that are contained entirely within the local cluster.

---

**CMMVC6450W** A FlashCopy mapping was created but physical\_flash is not enabled.

**Explanation:** The create FlashCopy mapping task has succeeded. However, physical\_flash should be enabled when you create a FlashCopy mapping in the physical disk license scheme.

**User response:** Ensure that you have the appropriate virtualization license for the cluster configuration that you want to enable. Ensure that the license settings for this cluster match the license.

Delete the FlashCopy mapping or enable physical\_flash.

---

**CMMVC6451W** A Global Mirror or Metro Mirror relationship was created but physical\_remote is not enabled.

**Explanation:** The create Global Mirror or Metro Mirror relationship task has succeeded. However, physical\_remote should be enabled when you create a Global Mirror or Metro Mirror relationship and the cluster uses the physical disk license scheme.

**User response:** Ensure that you have the appropriate virtualization license for the cluster configuration that you want to enable. Ensure that the license settings for this cluster match the license.

Delete the Global Mirror or Metro Mirror relationship or enable physical\_remote.

---

**CMMVC6452W** You are using the physical disk license scheme but the values for physical\_flash and physical\_remote are not set.

**Explanation:** The task has succeeded. However, you should enable physical\_flash before you create a FlashCopy mapping and you should enable physical\_remote before you create a Global Mirror or Metro Mirror mapping.

**User response:** Enable physical\_flash before you create a FlashCopy mapping. Enable physical\_remote before

you create a Global Mirror or Metro Mirror relationship.

---

**CMMVC6453W** You have disabled the physical disk license scheme but the capacity license scheme is not set.

**Explanation:** The task has succeeded. However, you should configure a license scheme before you create a FlashCopy, Global Mirror or Metro Mirror relationship. You can configure a physical disk license scheme or a capacity license scheme, but not both.

**User response:** If you do not have a virtualization feature license that is valid for this cluster, contact your IBM sales representative and obtain a license. Ensure that the license settings for this cluster match the license that you have for this cluster.

---

**CMMVC6454E** The command failed because the physical disk license scheme is not enabled.

**Explanation:** You can only enable `physical_flash` or `physical_remote` when the physical disk license scheme is enabled.

**User response:** Ensure that you have the appropriate virtualization license for the cluster configuration that you want to enable. Ensure that the license settings for this cluster match the license. Resubmit the task if it supported by the license.

---

**CMMVC6455E** The command failed because a capacity license scheme parameter was specified but the physical disk license scheme is enabled.

**Explanation:** You cannot enable the capacity license scheme or specify a capacity license scheme parameter while the cluster is using the physical disk license scheme.

**User response:** Ensure that you have the appropriate virtualization license for the cluster configuration that you want to enable. Ensure that the license settings for this cluster match the license. Resubmit the task if it supported by the license.

---

**CMMVC6456E** The command failed because a physical disk license scheme parameter was specified but the capacity license scheme is enabled.

**Explanation:** You cannot enable the physical disk license scheme or specify a physical disk license scheme parameter while the cluster is using the capacity license scheme.

**User response:** Ensure that you have the appropriate virtualization license for the cluster configuration that you want to enable. Ensure that the license settings for

this cluster match the license. Resubmit the task if it supported by the license.

---

**CMMVC6457E** One or more quorum disks are on the specified controller.

**Explanation:** You cannot disable the setting that allows a controller to support a quorum disk while a quorum disk is configured on the controller.

**User response:** Move all quorum disks from the controller to a different storage system using the `setquorum` command, and resubmit this task.

---

**CMMVC6458E** The specified controller cannot support quorum disks.

**Explanation:** The controller type of the controller that you specified does not support quorum disks.

**User response:** Specify a controller that has a controller type that supports quorum disks, and resubmit the task.

---

**CMMVC6459E** The `mkrcrelationship` command failed because the same VDisk was specified as the master and auxiliary VDisk.

**Explanation:** A relationship cannot be created from a volume to itself. The `mkrcrelationship` command requires that you specify two different volumes for the master and auxiliary positions. These can be two volumes in the local cluster, or a volume in each of two different clusters.

**User response:** Specify a master volume and an auxiliary volume that are not identical to each other, and resubmit the task.

---

**CMMVC6460E** The command failed because the migration source is offline.

**Explanation:** The source of the migration is offline. The offline source is either an image mode MDisk or the entire storage pool.

**User response:**

- If you submitted the `rmmdisk` command and specified a regular MDisk, determine the storage pool to which the source MDisk is defined, and follow the procedure for bringing the storage pool online. There will be an entry in the event log for the corresponding storage pool.
- If you submitted the `rmmdisk` command and specified an image mode MDisk, determine the source MDisk and follow the procedure for bringing the image mode MDisk online. There will be an entry in the event log for the corresponding MDisk.
- If you submitted a command to migrate a copy of an image mode volume, determine the corresponding source MDisk and follow the procedure for

diagnosing problems with MDisks. There will be an entry in the event log for the corresponding MDisks.

- If you submitted any other command to migrate a volume copy, determine the storage pool to which the volume is defined, and follow the procedure for bringing the storage pool online. There will be an entry in the event log for the corresponding storage pool.

---

**CMMVC6461E** The command failed because starting the migration will result in VDisks going offline in the source managed disk group.

**Explanation:** A migration from an image mode volume will use the source storage pool and the source storage pool assumes the combined state of the image mode MDisk and the storage pool. If the online or offline states of the image mode MDisk and the storage pool are different on different nodes, the source volume might go offline or all of the volumes in the source storage pool might go offline.

**User response:** For each node, note the online or offline states of the source volume and the source storage pool. If one entity is online and the other is offline, bring online whichever is offline. Taking the online entity offline is not recommended because other volumes might go offline.

---

**CMMVC6462E** The command failed because starting the migration will result in VDisks going offline because the target managed disk group is offline.

**Explanation:** The migration process assigns the volume an online or offline state based on the states of the source and target storage pools. In this case, based on the offline state of the target storage pool the volume that is currently online would have been taken offline. The command cannot be initiated because this action is not supported. There will be an entry in the event log for the corresponding storage pool.

**User response:** For each node, note the online or offline state of the source and target storage pools. For each node, if one of these two storage pools is online and the other is offline, bring online whichever storage pool is offline. Taking the online storage pool offline is not recommended because other volumes might go offline.

---

**CMMVC6463E** The command failed because Starting the migration will result in VDisks going offline because a target MDisk is offline.

**Explanation:** The volume is currently online. The migration process assigns the volume an online or offline state based on the states of the source and target MDisks. In this case, based on the offline state of the

target MDisk, the volume would have been taken offline. The task cannot be initiated because this action is not supported.

**User response:** Bring the target MDisk online by following the recommended procedure for bringing an MDisk online, and resubmit the command.

---

**CMMVC6464E** The Create FlashCopy mapping task cannot be initiated because the size of the source VDisk is being changed by a previously submitted task.

**Explanation:** You cannot submit this task while the Change volume size task is in progress.

**User response:** Wait until the Change volume size task completes, and then resubmit the task.

---

**CMMVC6465E** The Create FlashCopy mapping task cannot be initiated because the size of the target VDisk is being changed by a previously submitted task.

**Explanation:** You cannot submit this task while the Change volume size task is in progress.

**User response:** Wait until the Change volume size task completes, and then resubmit the task.

---

**CMMVC6466E** The Create FlashCopy mapping task cannot be initiated because an identical map already exists.

**Explanation:** A map between the source and target volumes that you have specified is defined. You cannot define a map that is exactly the same as a map that is already defined.

**User response:** Specify a unique map when you submit this task.

---

**CMMVC6467E** The Create FlashCopy mapping task cannot be initiated because a FlashCopy map with the same target VDisk already exists in the consistency group.

**Explanation:** You cannot create more than one FlashCopy map with the same target volume in the same consistency group.

**User response:** Specify a target volume for the FlashCopy map that is unique to the consistency group when you submit this task.

---

**CMMVC6468E** The Start or Prepare FlashCopy mapping task cannot be initiated because the target volume is the source of a different FlashCopy map that is being restored.

**Explanation:** You cannot start or prepare a map while the target of the map is the source volume of another

FlashCopy mapping that is being restored.

**User response:** Ensure that the target volume in the map that you are attempting to start or prepare is not the source volume of another FlashCopy mapping that is being restored when you submit the task. You could stop the associated map that is being restored, or you could wait for the map that is being restored to reach the Idle\_or\_Copied state.

---

**CMMVC6469E The Split stop FlashCopy map task cannot be initiated because the mapping is either being restored or is not in the copy complete state.**

**Explanation:** You cannot split stop a FlashCopy map while it is being restored or is not in the copy complete state.

**User response:** Ensure that the map is not being restored and is in the copy complete state when you submit this task.

---

**CMMVC6470E The Start or Prepare FlashCopy mapping task cannot be initiated because the target VDisk is being used by a different FlashCopy map.**

**Explanation:** You cannot start or prepare a map while the target of the map is also the target volume of another map that is in one of the following states: copying, stopping, suspended, prepared or preparing.

**User response:** Ensure that the target volume in the map that you are attempting to start or prepare is not the target volume of another FlashCopy mapping that is in one of the unsupported states when you submit this task.

---

**CMMVC6471E The Create cluster partnership task cannot be initiated because a cluster in the existing partnership has a downlevel software version that does not support this configuration.**

**Explanation:** One scenario in which this error occurs is when a cluster at version 5.1.0 or later is partnered to a cluster at version 4.3.1 or earlier and you attempt to create another partnership to a cluster at version 5.1.0 to implement multiple cluster mirroring. Software version 4.3.1 does not support multiple cluster mirroring, so adding a partnership to a third cluster is not supported while at least one cluster in the current partnership is at version 4.3.1 or earlier.

**User response:** Either upgrade the downlevel cluster software version to a version that supports this task or remove the partnership to the cluster that has the downlevel software version, and resubmit the task.

---

**CMMVC6472E The Create cluster partnership task cannot be initiated because the remote cluster with which you are attempting to create a partnership has a downlevel software version that does not support this configuration.**

**Explanation:** The software versions of the clusters in the existing partnership do not support a partnership with a cluster that has the software version of the remote cluster with which you are attempting to create a partnership. If a cluster at version 5.1.0 or later is already in a partnership with another cluster at version 5.1.0 or later, you can only add a partnership to a cluster at version 5.1.0 or later, and cannot add a partnership to a cluster at version 4.3.1 or earlier. If a cluster at version 5.1.0 or later is already in a partnership with another cluster at version 4.3.1 or earlier, you cannot add another partnership while the partnership with the cluster at version 4.3.1 exists. If a cluster is not in a partnership, you can create a partnership between it and a cluster at any version. One scenario in which this error occurs is when you attempt to add a partnership with a remote cluster at version 4.3.1 or earlier to a cluster at software version 5.1.0 or later that is already in partnership with another cluster at software version 5.1.0 or later.

**User response:** Either upgrade the downlevel cluster software version to a version that supports this task or remove all existing partnerships from the cluster to which you want to partner the cluster that has the downlevel software version, and resubmit the task.

---

**CMMVC6473E The partnership task cannot be initiated because the supported maximum number of accessible remote clusters would be exceeded.**

**Explanation:** With multiple cluster mirroring, you can build a configuration of a chain of clusters. There is a limit to the number of clusters that you can configure in the chain. The task would have resulted in exceeding the supported maximum number of clusters in a chain.

**User response:** Ensure that the resulting configuration is supported when you submit this task.

---

**CMMVC6474E The Create partnership task cannot be initiated because there is a Global Mirror or Metro Mirror relationship or consistency group that has a deleted partnership.**

**Explanation:** You must resolve the unpartnered objects error that is related to the deleted partnership with a Global Mirror or Metro Mirror relationship or consistency group before you can create a partnership from the local cluster to more than one other cluster.

**User response:** Resolve the unpartnered objects error, and resubmit the task. To resolve the error, either delete

the unpartnered Global Mirror or Metro Mirror relationship or consistency group from the deleted partnership, or create a partnership for the unpartnered objects.

---

**CMMVC6475E** The Add relationship to group task cannot be initiated because the master cluster of the relationship that you are attempting to add to the group is the auxiliary cluster of the group, and the auxiliary cluster of the relationship that you are attempting to add to the group is the master cluster of the group.

**Explanation:** All of the relationships within a group must have the same master cluster as the group and must have the same auxiliary cluster as the group. The determination as to which cluster is assigned as the master cluster when you create a relationship or consistency group is based on the cluster from which you submit the task.

**User response:** Perform one of the following three options:

- Delete the group and create the group so that the master cluster of the group is identical to the master cluster of the relationship and the auxiliary cluster of the group is identical to the auxiliary cluster of the relationship.
- Delete the relationship and create the relationship so that the master cluster of the relationship is identical to the master cluster of the group and the auxiliary cluster of the relationship is identical to the auxiliary cluster of the group.
- Specify a group and a relationship that have identical master clusters and identical auxiliary clusters.

Resubmit the task.

---

**CMMVC6478E** The Enable remote authentication service task cannot be initiated because the server settings are not configured.

**Explanation:** You cannot enable the remote authentication service until the server has been configured with all of the required settings. You must specify the user name, password, and remote authentication server URL, and if required, the SSL certificate.

**User response:** Ensure that the server settings are configured correctly, and resubmit the task.

---

**CMMVC6479E** The task cannot be initiated because the user group table is full.

**Explanation:** The maximum supported number of user groups is already configured in the user group table.

**User response:** Delete a user group that is not required from the table, and resubmit the task.

---

**CMMVC6480E** The task cannot be initiated because the user group that you have specified is not defined.

**Explanation:** You must specify a user group that exists in the user group table.

**User response:** Either create the user group that you had specified or specify an existing user group, and resubmit the task.

---

**CMMVC6481E** The Modify user group task cannot be initiated because you have specified a default user group.

**Explanation:** Examples of default user groups are SecurityAdmin, Administrator, CopyOperator, Service, and Monitor.

**User response:** Specify a user group that is not a default user group when you submit this task.

---

**CMMVC6482E** The Delete user group task cannot be initiated because you have specified a default user group.

**Explanation:** Examples of default user groups are SecurityAdmin, Administrator, CopyOperator, Service, and Monitor.

**User response:** Specify a user group that is not a default user group when you submit this task.

---

**CMMVC6483E** The task cannot be initiated because the user group name that you have specified already exists.

**Explanation:** Each user group must have a unique name.

**User response:** If you want to define a new user group with the name that you had specified, you must first delete the existing user group that has that same name. Specify a user group name that does not exist when you submit this task.

---

**CMMVC6484E** The task cannot be initiated because the role that you have specified is not supported.

**Explanation:** Examples of valid roles are SecurityAdmin, Administrator, CopyOperator, Service, and Monitor.

**User response:** Specify a supported role, and resubmit the task.

---

**CMMVC6485E** The Delete user group task has failed because there is at least one user that is defined as a member of the group, and you did not specify the -force parameter.

**Explanation:** You cannot delete a user group that is



not empty unless you specify the `-force` parameter. If you use the `-force` parameter when you delete a user group, all of the users that were in the deleted user group are added to the Monitor user group.

**User response:** Ensure that you specify the correct user group. For each member of the specified user group that you want to belong to a user group other than Monitor, move that member to the desired group. If the user group has at least one member, specify the `-force` parameter when you submit the task.

---

**CMMVC6486E** The task cannot be initiated because the user table is full.

**Explanation:** The maximum supported number of users is already configured in the user table.

**User response:** Delete a user that is not required from the table, and resubmit the task.

---

**CMMVC6487E** The task cannot be initiated because the user name that you have specified already exists.

**Explanation:** Each user must have a unique name.

**User response:** If you want to define a new user with the name that you had specified, you must first delete the existing user that has that same name. Specify a user name that does not exist when you submit this task.

---

**CMMVC6488E** The task cannot be initiated because you have specified a user group ID that is not correct.

**Explanation:** You must specify a valid user group ID when you submit this task.

**User response:** Specify a valid user group ID, and resubmit the task.

---

**CMMVC6489E** The task cannot be initiated because you have specified more than one password.

**Explanation:** This task allows you to specify only one password.

**User response:** Specify only one password, and resubmit the task.

---

**CMMVC6490E** The task cannot be initiated because you have specified both a user group and the use of the remote authentication service.

**Explanation:** You cannot specify a user group when you specify the use of the remote authentication service.

**User response:** Either specify a user group or specify

the use of the remote authentication service, but not both, and resubmit the task.

---

**CMMVC6491E** The task cannot be initiated because you have specified the use of the remote authentication service but you have not specified an SSH key and password.

**Explanation:** An SSH key and password are both required to use the remote authentication service.

**User response:** Specify a valid SSH key and a valid password when you submit this task.

---

**CMMVC6492E** The task cannot be initiated because you have specified a local user but you have not specified a user group.

**Explanation:** You must specify a user group when you specify a local user for this task.

**User response:** Specify a valid user group if you specify a local user when you submit this task.

---

**CMMVC6493E** The task cannot be initiated because the user that you have specified is not defined.

**Explanation:** You must specify a user that exists in the user table.

**User response:** Either create the user that you had specified or specify an existing user, and resubmit the task.

---

**CMMVC6494E** The task cannot be initiated because you cannot remove a default user.

**Explanation:** Examples of default users are SecurityAdmin, Administrator, CopyOperator, Service, and Monitor.

**User response:** Specify a user that is not a default user when you submit this task.

---

**CMMVC6495E** The task cannot be initiated because the user superuser must be a local user.

**Explanation:** You cannot define the user superuser to use the remote authentication service.

**User response:** Ensure that you have specified the correct user, and resubmit the task.

---

**CMMVC6496E** The task cannot be initiated because you cannot remove the superuser password.

**Explanation:** The user superuser must always have a password defined.

**User response:** Ensure that you have specified the correct user when you submit the task.

---

**CMMVC6497E** The task cannot be initiated because the user that you have specified does not have a password defined.

**Explanation:** You cannot remove a password that does not exist.

**User response:** Ensure that you have specified the correct user when you submit the task.

---

**CMMVC6498E** The task cannot be initiated because the user that you have specified does not have an SSH key defined.

**Explanation:** You cannot remove an SSH key that does not exist.

**User response:** Ensure that you have specified the correct user when you submit the task.

---

**CMMVC6499E** The task has failed because the SSH key that you have specified is already defined for another user.

**Explanation:** A single SSH key cannot be defined for more than one user.

**User response:** Either specify a unique SSH key for the user that you had specified or delete the user that has the SSH key that you had specified, and resubmit the task.

---

**CMMVC6500E** The action failed because the source and destination virtual disks (VDisks) are the same.

**Explanation:** The action failed because the source and destination volumes are the same.

**User response:**

---

**CMMVC6501E** The action failed because the node hardware is incompatible with the current I/O group member.

**Explanation:** The action failed because the node hardware is incompatible with the current I/O group member.

**User response:**

---

**CMMVC6502E** The FlashCopy mapping was not prepared because preparing consistency group 0 is not a valid operation.

**Explanation:** The FlashCopy mapping was not prepared because preparing consistency group 0 is not a valid operation.

**User response:**

---

**CMMVC6503E** The FlashCopy mapping or consistency group was not stopped because stopping consistency group 0 is not a valid operation.

**Explanation:** The FlashCopy mapping or consistency group was not stopped because stopping consistency group 0 is not a valid operation.

**User response:**

---

**CMMVC6504E** The task cannot be initiated because the SSH key file that you have specified does not contain a valid SSH key.

**Explanation:** You must specify an SSH key file that contains a valid SSH key.

**User response:** Specify an SSH key file that contains a valid SSH key, and resubmit the task.

---

**CMMVC6505E** The task has failed because an error has occurred while communicating with the authentication service.

**Explanation:** The cluster is configured to use an authentication service to control which users are authorized to access the cluster. An error has occurred while the cluster was attempting to contact the authentication service. The error is probably the result of an incorrect configuration, either of the cluster or of the authentication service. This error occurs if the SSL certificate, user name or password is incorrect.

**User response:** Ensure that the authentication service is functioning properly. Ensure that the cluster authentication service configuration is correct. Resubmit the task.

---

**CMMVC6506E** The task has failed because a timeout has occurred while communicating with the authentication service.

**Explanation:** The cluster is configured to use an authentication service to control which users are authorized to access the cluster. A timeout has occurred while the cluster was attempting to contact the authentication service. This timeout is probably the result of a TCP/IP network problem or of an incorrect configuration. Configuring the incorrect IP address or protocol in the authentication service URL causes this error. The protocol can be either http or https.

**User response:** Ensure that the cluster authentication service configuration is correct. Ensure that the Ethernet network between the cluster and the authentication service is functioning properly. Ensure that the authentication service is functioning properly. Resubmit the task.

---

**CMMVC6507E The task has failed because the authentication service reports an incorrect user name or password.**

**Explanation:** The cluster is configured to use an authentication service to control which users are authorized to access the cluster.

If the password for the user name has recently been changed on the authentication service, you might be required to force the cluster to refresh its authentication cache. You can force the refresh using the cluster console View Cluster Properties, Remote Authentication panel or by submitting the Command-Line Interface command **chauthservice -refresh**.

**User response:** Ensure that the user name and password that you use is correct.

If the password for the user name has recently been changed on the authentication service, force the cluster to refresh its authentication cache.

If the user name that you are using also has a password configured on the cluster, ensure that the password that is configured on the cluster is identical to the password that is configured for that user name on the authentication service.

Resubmit the task.

---

**CMMVC6508E The task has failed because the authentication service reports that the authentication token has expired.**

**Explanation:** The cluster is configured to use an authentication service to control which users are authorized to access the cluster. The authentication token, which is saved as a browser cookie, has expired. You can modify the token expiration property that is set by the authentication service to reduce the frequency of this error in the future.

**User response:** Either acquire a new authentication token or log in with a user name and password, and resubmit the task.

---

**CMMVC6509E The task has failed because the user name is not configured on the cluster.**

**Explanation:** If the user name is defined on an authentication service and you want to use that service for cluster authentication, you must configure the cluster to use that authentication service.

**User response:** Ensure that you are using the correct user name.

If the user name is not configured on the cluster and you want to use the cluster to authenticate, create a new user with the user name that you want to use on the cluster.

If the user name is defined on an authentication service and you want to use that service for cluster

authentication, configure the cluster to use that authentication service.

Resubmit the task.

---

**CMMVC6510E The task has failed because the password is not correct for the user name that you are using.**

**Explanation:** The password that you are using does not match the password that is configured on the cluster for the user name that you are using.

**User response:** Enter the correct password, and resubmit the task.

---

**CMMVC6511E The task has failed because the cluster is not configured correctly to use the authentication service.**

**Explanation:** The user name that you are using is configured to be authenticated using an authentication service, but either the cluster is not configured to use an authentication service or the function is not enabled.

**User response:** If you want to use an authentication service, configure the cluster to use the service.

If you do not want to use an authentication service, modify the configuration of the user name on the cluster to remove the designation for the use of the authentication service.

Resubmit the task.

---

**CMMVC6512E The task has failed because you cannot both create a new quorum disk and set that new disk to active using the same command.**

**Explanation:** The create new quorum disk task and set disk to active task must be done using two separate tasks.

**User response:** Submit a create new quorum disk task. When that task has completed, submit a task to activate the new disk.

---

**CMMVC6513E The task has failed because you cannot activate a quorum disk until all of the quorum disks have been initialized.**

**Explanation:** The initialization process for at least one disk has not yet completed. You cannot select a disk as the active disk until the initialize process for all of the quorum disks has completed.

**User response:** Wait until the initialize quorum disk process has completed for all of the quorum disks, and resubmit the task.

---

**CMMVC6514E** The task has failed because the disk that you have selected to activate is not online.

**Explanation:** A disk must be online to be eligible for activation.

**User response:** Either bring the disk that you have selected online or select a different disk that is already online, and resubmit the task.

---

**CMMVC6515E** The task has failed because at least one quorum disk is in the Excluded state.

**Explanation:** You cannot activate a quorum disk when one or more of the quorum disks are in the Excluded state.

**User response:** Either create additional quorum disks or change the configuration so that none of the quorum disks is in the Excluded state. Ensure that none of the quorum disks are in the Excluded state, and resubmit the task.

---

**CMMVC6516E** The command has failed because an IPv4 cluster address cannot be removed while remote IPv4 services are configured.

**Explanation:** The configured management IP address protocols determine whether IPv4 or IPv6 or both are enabled on the cluster. If a cluster does not have an IPv4 cluster address the IPv4 protocol stack will not be enabled, and therefore remote services such as email servers or SNMP servers cannot be accessed through an IPv4 address.

**User response:** If you can only access the service through an IPv4 address and you need to continue to use the service, you will also have to continue to specify an IPv4 cluster address even if you do not intend to manage your cluster through this address.

Otherwise, re-configure the cluster so that all remote services use only IPv6 addresses, and resubmit the task to remove the IPv4 cluster address.

---

**CMMVC6517E** The command has failed because an IPv6 cluster address cannot be removed while remote IPv6 services are configured.

**Explanation:** The configured management IP address protocols determine whether IPv4 or IPv6 or both are enabled on the cluster. If a cluster does not have an IPv6 cluster address the IPv6 protocol stack will not be enabled, and therefore remote services such as email servers or SNMP servers cannot be accessed through an IPv6 address.

**User response:** If you can only access the service through an IPv6 address and you need to continue to

use the service, you will also have to continue to specify an IPv6 cluster address even if you do not intend to manage your cluster through this address.

Otherwise, re-configure the cluster so that all remote services use only IPv4 addresses, and resubmit the task to remove the IPv6 cluster address.

---

**CMMVC6518E** The task has failed because no roles are defined for the current user on the cluster.

**Explanation:** The cluster has been configured to use an authentication service to control which users are authorized to access the cluster. The user's credentials were accepted by the authentication service, but none of the groups defined for the user on the authentication service match any of the user groups that are defined on the cluster.

**User response:** Perform the following steps in sequence:

1. Determine which user groups are defined for the user on the authentication service.
2. Ensure that at least one user group that is defined for the user on the authentication service is also defined on the cluster.
3. Ensure that at least one user group that is defined for the user on both the authentication service and the cluster has its 'remote' parameter set to 'enabled'.
4. Resubmit the task.

---

**CMMVC6519E** The task has failed because you cannot change the user group of the 'superuser' account to anything other than 'SecurityAdmin'.

**Explanation:** The user group that is assigned to the user name 'superuser' must always be 'SecurityAdmin'. This assignment cannot be changed.

**User response:** Ensure that you specify a user account other than 'superuser' if you submit a task to change the user group of a user account from 'SecurityAdmin' to a different user group.

---

**CMMVC6520E** You cannot use this task to modify the properties of the current user because those properties are only defined by an authentication service.

**Explanation:** The current user is not defined on the cluster. The current user is defined on an authentication service, and the cluster is configured to use that authentication service. You must use the authentication service to change the current user's password.

If you want to enable command-line interface (CLI) access to the cluster by using an SSH key, you must define the current user on the cluster and associate the SSH key with that user. If you also want to continue

using the authentication service for the current user, you must enable the 'remote' setting for the new current user account that you create on the cluster.

**User response:** If you want to change your password, use the authentication service for that task.

If you want to enable command-line interface (CLI) access to the cluster by using an SSH key, define your user account on the cluster and associate the ssh key with that definition. If you also want to continue using the authentication service to authorize your user account, enable the 'remote' setting for your newly created user account on the cluster.

---

**CMMVC6521E** The task cannot be initiated because it would have resulted in a user account definition for a local user that specifies neither a password nor an SSH key.

**Explanation:** The definition of a local user must always specify either a password or an SSH key.

**User response:** When you submit this task, ensure that you have specified the correct user account and parameters, and that all local user definitions would still specify either a password or an SSH key after the task completes.

---

**CMMVC6522E** Authorization has failed.

**Explanation:** An SSH login attempt has failed. This message will be followed by a second message that will contain detailed information about the cause of the error.

**User response:** Follow the instructions in the second error message to solve the problem.

---

**CMMVC6523E** The URL that you have entered is not valid.

**Explanation:** The URL must start with either http:// or https:// and must use only the following characters: A-Z, a-z, 0-9, - \_ : [ ] . ~ / %.

**User response:** Ensure that the URL that you enter starts with one of the supported strings and contains only supported characters, and resubmit the task.

---

**CMMVC6524E** The name that you have entered is not valid. The name cannot begin or end with a space character, and the name cannot contain any of the following characters: \* : , \ ' %

**Explanation:** A space cannot be the first or last character in the name that you enter. Also, the following characters are not supported anywhere in the name: \* : , \ ' %

**User response:** Ensure that the name that you enter does not begin or end with the space character and that

it does not contain any of the unsupported characters listed above, and resubmit the task.

---

**CMMVC6525E** The password that you have entered is not valid. The password cannot begin or end with a space character.

**Explanation:** A space cannot be the first or last character in the password that you enter.

**User response:** Ensure that the password that you enter does not begin or end with the space character, and resubmit the task.

---

**CMMVC6526E** The Create VDisk task cannot be initiated because the number of copies that you have requested is not equal to the number of unique MDisk groups that you have specified.

**Explanation:** When you submit this task, you must specify a unique storage pool for each volume copy that you request.

**User response:** Specify the same number of unique storage pools as the number of volume copies that you request, and resubmit the task.

---

**CMMVC6527E** The name that you have entered is not valid. The name can contain letters, numbers, spaces, periods, dashes, and underscores. The name must begin with a letter or an underscore. The name must not begin or end with a space.

**Explanation:** A number or space cannot be the first character and a space cannot be the last character in the name that you enter. Also, the following characters are not supported anywhere in the name: \* : , \ ' % #

**User response:** Ensure that the name you enter does not begin with a number, does not begin or end with a space character, and does not contain any of the unsupported characters listed above, and resubmit the task.

---

**CMMVC6528E** The command cannot be initiated because the MDisk mode is not set to Array.

**Explanation:** Any MDisk that you specify for this command must be a local MDisk that is an array of LDisk. The mode of the MDisk that you have specified is not Array.

**User response:** Either select a different MDisk that is a local MDisk and is an array of LDisk, or configure the system so that the MDisk that you have specified is a local MDisk and is an array of LDisk, and resubmit the command.

---

**CMMVC6529E** The command cannot be initiated because the maximum supported number of MDisks already exists.

**Explanation:** This command requires that an MDisk is available for array creation. There are no available MDisks for array creation because the maximum number of MDisks is already configured on the cluster.

**User response:** Ensure that a local MDisk is available, and resubmit the command. To make a local MDisk available for this task, either delete an array on an existing local MDisk or remove a SAN attached MDisk and configure a local MDisk.

---

**CMMVC6530E** The command cannot be initiated because the maximum supported number of arrays already exists.

**Explanation:** The cluster already has the maximum number of arrays that it can support. The command attempted to add a new array.

**User response:** Remove an array that is no longer needed, and resubmit the command.

---

**CMMVC6532E** The command cannot be initiated because there is insufficient free memory that is available to the I/O group.

**Explanation:** This command requires that there is sufficient free memory available for the specified I/O group to allocate the memory that is required for the new array.

**User response:** Ensure that there is sufficient memory available to the I/O group, and resubmit the command. You can increase the amount of memory that is allocated to the I/O group. You can also reduce the amount of memory that is used by reducing the number volume mirrors or Copy Services relationships in the I/O group.

---

**CMMVC6533E** The command cannot be initiated because the specified array member does not exist in the selected array.

**Explanation:** This command requires that the array member that you specify is an LDisk. It is possible that the array member that you specified was an LDisk that was recently deconfigured due to an error. You can use the **lsarraymember** command to display the available members of an array.

**User response:** Select an array member that has an associated LDisk, and resubmit the command.

---

**CMMVC6534E** The command cannot be initiated because the drive that you have specified does not exist.

**Explanation:** You have specified a drive ID that is not defined.

**User response:** Use the **lsdrive** command to display existing drive IDs. Specify only existing drive IDs, and resubmit the command.

---

**CMMVC6535E** The command cannot be initiated because you have specified an insufficient number of drives to configure an array using the RAID geometry that you have specified.

**Explanation:** Each RAID geometry requires a minimum number of available drives in order to configure an array using that geometry. For example, a RAID 6 geometry requires that you specify at least four available drives. The number of drives that you have specified is less than the minimum number of drives that are required for the RAID geometry that you have specified.

**User response:** Ensure that you specify a sufficient number of drives to accommodate the RAID geometry that you specify, and resubmit the command. You might want to specify a different number of drives or a different RAID geometry.

---

**CMMVC6536E** The command cannot be initiated because you have specified more drives than the specified RAID geometry permits.

**Explanation:** The number of drives that you specify must be within the supported range of number of drives that is supported for the RAID geometry that you specify. For example, a RAID 1 geometry requires that you specify exactly two available drives.

**User response:** Specify a number of available drives that is supported for the RAID geometry that you specify, and resubmit the command.

---

**CMMVC6537E** The command cannot be initiated because the drive that you have specified has a Use property that is not supported for the task.

**Explanation:** You can submit the **lsdrive** command to display the Use property of a drive and to determine which drives are available.

**User response:** Consult the command documentation to determine what drive Use property values are supported for this command. Ensure that you select a drive that has a value for the Use property that is supported when you submit this command.

---

**CMMVC6538E** The command cannot be initiated because at least one of the drives that you have specified has a Use property that is not Candidate.

**Explanation:** Every drive that you specify for this command must have a Use property of Candidate. You can submit the **lsdrive** command to display the Use property of existing drives.

**User response:** Ensure that all of the drives that you specify have a Use property of Candidate, and resubmit the command.

---

**CMMVC6539E** The command cannot be initiated because the array does not have sufficient redundancy.

**Explanation:** The array must have sufficient redundancy when you submit this command. The task that you have requested would have taken the array offline.

**User response:** Fix all errors that are related to the array that you have specified and restore redundancy to the array before you resubmit the command.

---

**CMMVC6540E** The task cannot be initiated because the space-efficient grain size is too small to accommodate the virtual capacity that you have requested for the VDisk.

**Explanation:** The virtual capacity that you have requested would require a larger number of grains than the supported maximum for the specified grain size.

**User response:** Either increase the grain size, decrease the requested virtual capacity of the volume, or both, and resubmit the task.

---

**CMMVC6541E** The task cannot be initiated because the virtual capacity that you have requested for the space-efficient VDisk is larger than the maximum capacity that is supported for the extent size.

**Explanation:** The extent size of the storage pool that you have selected would require a larger number of extents than the supported maximum to accommodate the virtual capacity that you have requested for the thin-provisioned volume.

**User response:** Either select a different storage pool that has an extent size that is large enough to accommodate the requested virtual capacity or specify a virtual capacity that is supported for the extent size of the storage pool that you had selected, and resubmit the task.

---

**CMMVC6542E** The remote authentication task has failed.

**Explanation:** An error has occurred while attempting to authenticate a user account using a remote authentication service. You can run the **svc\_snap** task to gather cluster information that can be used in problem determination.

**User response:** Contact IBM technical support for assistance.

---

**CMMVC6543E** The task cannot be initiated because you can only specify a direct-attached managed drive when you submit the task.

**Explanation:** The drive that you have specified either is not managed or is not a local drive.

**User response:** Specify a direct-attached MDisk when you submit this task.

---

**CMMVC6544E** The task cannot be initiated at this time because the direct-attached managed drive that you have specified is too busy. Resubmit the task when the drive is less busy.

**Explanation:** The task takes approximately thirty seconds to complete. When the direct-attached managed drive is busy, the time that is required to complete the task increases. When the drive is too busy, the task cannot complete in a reasonable amount of time.

**User response:** Resubmit the task when the direct-attached managed drive is less busy.

---

**CMMVC6545E** The Apply Drive Software task has failed to access the software download image.

**Explanation:** Either the image file cannot be read, the validation signature is incorrect, the drive type or firmware type is not correct, or the image file has been corrupted.

**User response:** Reinstall the firmware download image, and resubmit the task. If the problem persists, contact IBM technical support for assistance.

---

**CMMVC6546E** A device error was detected during the Apply Drive Software task.

**Explanation:** The task might have succeeded.

**User response:** View the event in the event log. Determine the firmware level from the VPD of the node. If the VPD does not show that the downloaded firmware version is installed, resubmit the task.

---

---

**CMMVC6547W** The Download FPGA firmware task has been initiated. The MDisk remains Offline while the task is in progress. Do not remove power from the drive or node while the task in is progress.

**Explanation:** The task might take approximately fifteen minutes to complete. When the task completes, the drive status changes to Online automatically.

**User response:** Ensure that electrical power is continuously being supplied to the node and the drive, at least until the task completes and the drive status changes to Online.

---

**CMMVC6548E** The FPGA firmware cannot be applied because the drive has a use other than candidate.

**Explanation:** Updating a drive FPGA level is not guaranteed to maintain data integrity, therefore the drive must not be part of an array. To ensure this, the drive must have a use of "candidate" before the package can be applied.

**User response:** If the drive is currently in the "failed" state, run through all maintenance actions required for the drive before continuing. If the drive is a spare or unused, the drive use can be changed through the GUI or through the **chdrive** command. If a drive is currently part of an array, a hot spare must be configured and the drive use changed to failed, before changing the use to candidate.

---

**CMMVC6549E** The Authentication task has failed because the authentication service URL that you have specified is not a valid URL.

**Explanation:** This error might be caused by the authentication service not operating correctly or by an incorrect URL being defined for the authentication service. You can use the **chauthservice** command to change the URL that is defined in the cluster for the authentication service.

**User response:** Ensure that the authentication service is operating correctly. Ensure that the authentication service URL that is defined in the cluster is correct, and resubmit the task.

---

**CMMVC6550E** The Authentication task has failed because the network address that is specified in the authentication service URL cannot be resolved.

**Explanation:** The authentication service URL that is defined in the cluster has a network address that cannot be resolved. You can use the **chauthservice** command to change the URL that is defined in the cluster for the authentication service.

**User response:** Ensure that the authentication service

is operating correctly. Ensure that the authentication service URL that is defined in the cluster is correct. Ensure that the network connection between the cluster and the authentication service is operating correctly, and resubmit the task.

---

**CMMVC6551E** The Authentication task has failed because the combination of user name and password that is defined in the cluster for authorization by the authentication service is not defined on the authentication service.

**Explanation:** The authentication service has refused an authentication request from the cluster. You can use the **chauthservice** command to change the user name or the password that is defined in the cluster for the authentication service.

**User response:** Ensure that the user name and password combination that is defined in the cluster for the authentication service is also defined on the authentication service, and resubmit the task.

---

**CMMVC6552E** The Authentication task has failed because an SSL connection could not be established with the authentication service.

**Explanation:** This error might be caused by an incorrect SSL configuration on the authentication service server or by a rejection by the authentication service server of the SSL certificate that is configured on the cluster. You can use the **chauthservice** command to set the SSL certificate that is defined in the cluster for the authentication service server.

**User response:** Ensure that the SSL configuration on the authentication service server is correct and that the SSL certificate that is defined in the cluster for the authentication service server is correct, and resubmit the task.

---

**CMMVC6553E** The task cannot be initiated because at least one quorum disk is not in the correct state.

**Explanation:** All of the quorum disks must have a state of Online when you set an MDisk to be the active quorum disk.

**User response:** Ensure that all of the quorum disks have a state of Online, and resubmit the task.

---

**CMMVC6554E** The Authentication task has failed because the user name that was received from the authentication service is not a valid cluster user name.

**Explanation:** The cluster user name cannot exceed 256 characters in length, and cannot contain any of the following characters:



- colon :
- percent sign %
- comma ,
- double quote ""
- single quote '

**User response:** Change the definition of the user name in the remote authentication service so that it conforms to the cluster user name requirements, and resubmit the task.

---

**CMMVC6555E The Authentication task has failed because the authentication service either sent an incorrect response, or it sent a response that indicates that the authentication request has failed for a reason other than incorrect authentication credentials.**

**Explanation:** Either the format of the response from the authentication service is not valid or the response indicates a failure to authenticate that is not related to the credentials that were being authenticated.

**User response:** Ensure that the authentication service is functioning correctly, and resubmit the task. If the problem persists, contact the authentication service technical support for assistance.

---

**CMMVC6556E The task cannot be initiated because an error has occurred while attempting to read a file.**

**Explanation:** The task specified the name of a file on the file system of the cluster configuration node. The specified file cannot be opened. This error might be caused by a typographical error in the file name that you specified or by a failover of the configuration node to a different node than the node into which you are currently logged in.

**User response:** Ensure that the file has been copied to the current configuration node and that you are logged in to that node, specify the correct file name, and resubmit the task.

---

**CMMVC6557E The task cannot be initiated because the file that you have specified is too large.**

**Explanation:** The task specified the name of a file on the file system of the cluster configuration node. The specified file cannot be used because it exceeds the maximum size supported for the task. If the file has been corrupted, you can copy the correct version of the file onto the configuration node to restore the correct file size. The maximum file size is described in the task help.

**User response:** Specify the correct file name and ensure that the size of the file does not exceed the

supported maximum file size for this task, and resubmit the task.

---

**CMMVC6558E The command cannot be initiated because it might cause VDisks to go Offline. Refer to the cluster Command-Line Interface (CLI) command help for this command.**

**Explanation:** You are being warned that this command might result in taking volumes Offline. After you completely understand the possible consequences by reading the command help, you can override the safety precautions and avoid this message by using the `-force` flag.

**User response:**

1. Submit the `lsnode dependantvdisks` command to determine which volumes will go Offline if you resubmit this command using the `-force` flag. If you received this message when you submitted the `applysoftware` command, you must submit the `lsnode dependantvdisks` command for every node in the cluster; for all other commands you must submit the `lsnode dependantvdisks` command for the node that you specified as a parameter in the command that generated this message.
2. This step is required because it is critically important that you understand the implications of using the `-force` flag for the specific command that you have submitted: Refer to the CLI command help to determine what safety precautions are bypassed when you use the `-force` flag. The ignored precautions differ, depending on the command.
3. If you want to bypass the safety precautions when you resubmit the command, you must use the `-force` flag.

---

**CMMVC6559E The Add or Change email user command has failed because you have specified a user type of 'support' and you have specified either the `-warning` or `-info` parameter value as 'on'.**

**Explanation:** The user type 'support' is intended to be used to indicate that the user is from a hardware maintenance support service external to your organization. Therefore, only events with the more serious notification type of 'error' can be sent to a 'support' user type.

**User response:** Ensure that you have specified the correct user type. If you want this user to receive warning or information notifications, do not specify the `-usertype support` parameter and value. If you specify the user type as 'support', you must specify the `-warning` and `-info` parameters as 'off'.

---

**CMMVC6560E** The command has failed because the specified IP address is already in use by the cluster.

**Explanation:** You cannot specify an IP address that is already configured to be used by the cluster.

**User response:** Ensure that the IP address that you specify is not already configured for use by the cluster, and resubmit the task.

---

**CMMVC6561E** The set quorum active task has failed because either another set quorum active task is in progress or the selected disk cannot be set as the active quorum disk.

**Explanation:** This is a multi-step task and can take from a few seconds to several minutes to complete. Only one set quorum active task can be in progress at any specified time. This error has one of two causes. Either another set quorum task is already in progress, or the internal cluster logic did not accept your request to make the selected disk the active quorum disk.

**User response:** Check the state of the MDisks and complete any outstanding fix procedures. If another set quorum active task might be in progress, wait for several minutes for that task to complete, and resubmit this task. If you have received this error when there is no other set quorum active task in progress, specify a different disk to replace the current active quorum disk and specify the same quorum index number, and resubmit this task.

---

**CMMVC6562E** The requested size exceeds the maximum supported value.

**Explanation:** You have submitted a command that has a size parameter and an associated unit option that has a default value of Megabytes (MB, 2e20 bytes) when the -unit option is not specified. The value that you have specified for the size parameter in combination with the specified or default unit value is greater than the maximum supported size of (2e64 - 1) bytes.

**User response:** Ensure that the size that you specify is correct for the value of the unit option that is defaulted or specified, and that the size is not greater than the maximum supported size, and resubmit the task.

---

**CMMVC6563E** The command has failed because a user that you have specified is not configured to receive email notifications.

**Explanation:** All of the users that you specify as a target recipient in the **testemail** command must already have at least one of the following email notification flags set to 'on': -error, -warning, or -info.

**User response:** Ensure that all of the users that you specify have at least one email notification flag set to

'on', and resubmit the command.

---

**CMMVC6564E** You cannot make this user a remote user because the password type is not valid for a remote user.

**Explanation:** The remote authentication server has requirements that do not accept legacy type passwords. This user has a legacy type password.

**User response:** Either specify a new password and resubmit the command, or first modify the password and then resubmit the command to designate remote authentication for this user.

---

**CMMVC6565E** The command has failed because the specified node is not online.

**Explanation:** The command requires that the status of the node that you specify is Online.

**User response:** Ensure that the node that you specify has a status of Online when you submit this command.

---

**CMMVC6566E** The command cannot be submitted because specifying the -failover parameter requires that you also specify either the -name, -iscsialias or -noiscsialias parameter.

**Explanation:** You have not specified the required failover data that is required when you specify the -failover parameter.

**User response:** Ensure that you want to specify the -failover parameter. When you specify the -failover parameter with this command, ensure that you also specify either the -name, -iscsialias or -noiscsialias parameter.

---

**CMMVC6567E** The Apply Drive Software task has failed because no download images were found in the package file.

**Explanation:** The drive software upgrade package file was unpacked but no download software images were found in the package.

**User response:** Acquire a valid solid-state drive software upgrade package file, and resubmit the task using the new package file.

---

**CMMVC6568E** The Apply Drive Software task has failed because no download images were found in the package file for this drive type.

**Explanation:** The package file documentation lists the drive types for which there are images.

**User response:** Acquire a valid solid-state drive software upgrade package file that contains an image

for this drive type, and resubmit the task using the new package file.

---

**CMMVC6569E** The Apply Drive Software task has failed because no download images were found in the package file of this software type.

**Explanation:** The package file documentation lists the drive types and software types for which there are images. The value of the -type parameter that you enter for software type is case-sensitive.

**User response:** Ensure that the value that you enter for the -type parameter exactly matches the software type that is contained in the solid-state drive software upgrade package file, and resubmit the command.

---

**CMMVC6570E** The command was not initiated because the cache mode of the virtual disk (VDisk) is already in the state that you had requested.

**Explanation:** You have issued a change volume cache mode command but requested the current mode, so there would not have been a change. Therefore, the command was ignored.

**User response:** List the volume properties to determine the current cache mode. If you want to change the cache mode, ensure that you specify a cache mode that is different from the current cache mode, and resubmit the command.

---

**CMMVC6571E** The command has failed because the I/O group that manages the virtual disk (VDisk) that you specified was offline when you submitted the command. You can use the -force flag to force the operation, which might result in the loss of cache data.

**Explanation:** If you submit this command without the -force flag, the I/O group that manages the volume that you specify must have a state of Online.

**Note:** Use of the -force flag when you change the cache mode might result in loss of the cache data for the volume, depending on the current cache mode and requested cache mode. One example of a risk of potential loss of cache data would be changing the cache mode from readwrite to none.

**User response:** Either follow service procedures to bring the I/O group online or specify the -force flag to force the change of the cache mode of the volume, and resubmit the task.

---

**CMMVC6572E** The command has failed because the I/O group that manages the virtual disk (VDisk) that you specified is not stable.

**Explanation:** The unstable I/O group condition is typically transient, and usually occurs during I/O group failover or fail back processing.

**User response:** Wait a few minutes, and resubmit the command.

---

**CMMVC6573E** The command has failed because the VDisk that you specified is a source or target of a FlashCopy mapping that is in the prepared state.

**Explanation:** If the volume is the source or target of a FlashCopy mapping, the FlashCopy mapping must be in the idle\_copied state or the stopped state when you change the cache mode of the volume.

**User response:** Either remove or stop the FlashCopy mapping and wait for the FlashCopy mapping state to become idle\_copied or stopped, and resubmit the command.

---

**CMMVC6574E** The command has failed because the VDisk that you specified is a source or target of a FlashCopy mapping that is in the suspended state.

**Explanation:** If the volume is the source or target of a FlashCopy mapping, the FlashCopy mapping must be in the idle\_copied state or the stopped state when you change the cache mode of the volume.

**User response:** Either remove or stop the FlashCopy mapping and wait for the FlashCopy mapping state to become idle\_copied or stopped, and resubmit the command.

---

**CMMVC6575E** The command has failed because the VDisk that you specified is a source or target of a FlashCopy mapping that is in the preparing state.

**Explanation:** If the volume is the source or target of a FlashCopy mapping, the FlashCopy mapping must be in the idle\_copied state or the stopped state when you change the cache mode of the volume.

**User response:** Either remove or stop the FlashCopy mapping and wait for the FlashCopy mapping state to become idle\_copied or stopped, and resubmit the command.

---

**CMMVC6576E** The command has failed because the VDisk that you specified is a source or target of a FlashCopy mapping that is in the stopping state.

**Explanation:** If the volume is the source or target of a FlashCopy mapping, the FlashCopy mapping must be

in the `idle_copied` state or the stopped state when you change the cache mode of the volume.

**User response:** Either remove or stop the FlashCopy mapping and wait for the FlashCopy mapping state to become `idle_copied` or stopped, and resubmit the command.

---

**CMMVC6577E** The command has failed because the VDisk that you specified is a source or target of a FlashCopy mapping that is in the copying state.

**Explanation:** If the volume is the source or target of a FlashCopy mapping, the FlashCopy mapping must be in the `idle_copied` state or the stopped state when you change the cache mode of the volume.

**User response:** Either remove or stop the FlashCopy mapping and wait for the FlashCopy mapping state to become `idle_copied` or stopped, and resubmit the command.

---

**CMMVC6578E** The command has failed because the iSCSI name is already assigned or is not valid.

**Explanation:** The cluster does not support duplicate iSCSI names. A valid iSCSI name cannot contain a comma or leading or trailing spaces.

**User response:** Ensure that you specify a unique and valid iSCSI name, and resubmit the command.

---

**CMMVC6579E** The command cannot be initiated because the cluster Ethernet port 1 must always be fully configured in either the IPv4 or IPv6 format.

**Explanation:** This error can be caused by an attempt to delete the only address that is configured on the primary Ethernet port on the cluster.

**User response:** When you delete an IP address on the primary Ethernet port, ensure that the other supported IP format is already configured on that port.

---

**CMMVC6580E** The command cannot be initiated because the iSCSI alias that you specified contained either leading or trailing space characters.

**Explanation:** The space character cannot be the starting or ending character of an iSCSI alias name.

**User response:** Ensure that the iSCSI alias that you specify does not begin or end with a space character, and resubmit the command.

---

**CMMVC6581E** The command has failed because the maximum number of allowed iSCSI qualified names (IQNs) has been reached, or the IQN is already assigned or is not valid.

**Explanation:** IQNs cannot exceed the maximum number allowed, must not be duplicated, must not contain a comma, and must not contain leading or trailing spaces.

**User response:** If the number of IQNs is within the allowed maximum, ensure that you specify a unique and valid IQN, and resubmit the command.

---

**CMMVC6582E** The task has failed because the iSCSI host that you specified is not mapped to an I/O group.

**Explanation:** You cannot add a port to an iSCSI host until you have mapped the iSCSI host to at least one I/O group.

**User response:** Map the iSCSI host to at least one I/O group, and resubmit the command.

---

**CMMVC6583E** The command has failed because the name that you specified contains a character that is not supported for a node or cluster name.

**Explanation:** A node or cluster name cannot contain any of the following characters or ASCII hexadecimal values:

- 0000-001F ASCII control characters
- 0020-002C The space character ' ' # \$ % the ampersand character ' ( ) \* + ,
- 002F /
- 003B-0040 ; the 'less than' character = > ? @
- 005B-0060 [ \ ] ^ \_ `
- 007B-007F { | } ~ and the DEL character

**User response:** Specify a valid name, and resubmit the command.

---

**CMMVC6584E** The command cannot be initiated because it would deconfigure the remote authentication service while the service is enabled.

**Explanation:** You cannot deconfigure the remote authentication service while it is enabled.

**User response:** Ensure that the remote authentication service is not being used, disable the service, and resubmit the task.

---

**CMMVC6585E** The command cannot be initiated because the array that you have specified has a geometry of RAID 0, which is not a redundant geometry.

**Explanation:** The array that you specify for this command must have a redundant geometry, and RAID 0 is not a redundant geometry.

**User response:** Ensure that you specify an array that has a redundant geometry when you submit the command.

---

**CMMVC6586E** The command cannot be initiated because the action would cause array data loss due to the unsynchronized state of the array.

**Explanation:** To avoid data loss, this command is not permitted to process an array that is not synchronized.

**User response:** Use the `lsarraysyncprogress` command to ensure that the synchronization process completes for this array, and resubmit the task.

---

**CMMVC6587E** The command did not complete because I/O for the array was not quiesced within the allotted time period.

**Explanation:** All outstanding I/O for the array must complete before the configuration can be changed. The command has failed because there is still outstanding I/O to be processed for the array, and the maximum amount of time allotted to the command has expired.

**User response:** Resubmit the task.

---

**CMMVC6588E** The command cannot be initiated because a drive that you have specified has a capacity that is smaller than the minimum capacity that is required for the array that you have specified.

**Explanation:** You can use the `lsarraymembergoals` command to identify the capacity requirement for a member of the array that you specified.

**User response:** Specify a drive that has sufficient capacity for the array that you specify when you submit the command.

---

**CMMVC6589E** The command was not initiated because the drive that you have specified does not sufficiently match the array member goals and you did not specify the `-balanced` parameter.

**Explanation:** If you do not specify the `-balanced` parameter, the new drive must be an exact match for the array member goals when you exchange a new drive for an existing array member. The new drive that you have specified does not match the goals. If you

want to use the drive that you specified to replace an existing member of the array that you specified, you must specify the `-balanced` parameter, which forces the array member goals to be changed to accommodate the new drive.

**User response:** Either select a different drive that matches the array member goals or specify the `-balanced` parameter to force a change in the array member goals to accommodate the new drive, and resubmit the command.

---

**CMMVC6590E** The command cannot be initiated because you did not specify the `-allowdegraded` parameter and the associated array member has insufficient spare protection.

**Explanation:** This command requires that spare drives are available to assume the function of array member drives that are removed from the array. The requirement can be bypassed by using the `-allowdegraded` parameter.

**User response:** Either configure sufficient additional spare drives or specify the `-allowdegraded` parameter, and resubmit the command.

---

**CMMVC6591E** The command cannot be initiated because the specified sequence number does not match the sequence number of any errors in the error log.

**Explanation:** The sequence number that is specified in the command must be identical to the sequence number of an event in the event log.

**User response:** Check the event log to verify the sequence number of the event that you want to specify, and resubmit the command using the correct sequence number.

---

**CMMVC6592E** The command cannot be initiated because at least one parameter that was specified is not supported when submitting a command to view the details of an error log entry.

**Explanation:** Filtering parameters such as `'-order severity'` or `'-status alert'` that are valid when listing multiple event log entries are not supported for the command to view the details of a single event log entry.

**User response:** Check the command syntax, and use supported syntax when you submit the command.

---

**CMMVC6593E** The command cannot be initiated because the error log entry has a status that is not supported for the command.

**Explanation:** Only events with a status of `'alert'` or `'message'` can be manually marked as fixed or unfixed.

## CMMVC6594E • CMMVC6613E

Events with a status of 'monitoring' or 'expired' are not required to be marked as fixed or unfixed.

**User response:** Check the event log to verify the sequence number of the event that you want to specify. Ensure that the event that you specify has a status that is supported for the command when you submit the command.

---

**CMMVC6594E** The command cannot be initiated because a drive was specified twice in the drive list.

**Explanation:** The drive list cannot contain any duplicate entries because the same drive cannot be a member of an array more than once.

**User response:** Ensure that the drive list that you specify does not contain any duplicate entries when you submit this task.

---

**CMMVC6595E** The command cannot be initiated because a drive that you have specified has a technology type that is not supported for the command.

**Explanation:** The command supports only certain drive technology types. You have specified at least one drive that has a technology type that is not supported for the command.

**User response:** Consult the command documentation to determine which drive technology types are supported for the command. Submit the `lsdrive` command to determine which drives are available. Specify an available drive that has a technology type that is supported for the command when you submit the command.

---

**CMMVC6596E** The command has failed because you have specified an I/O group that does not exist.

**Explanation:** You must specify an existing I/O group when you submit this command.

**User response:** Specify an existing I/O group, and resubmit the command.

---

**CMMVC6597E** The command has failed because the email settings are not configured.

**Explanation:** The email system settings must be configured before you can submit a command for error notifications.

**User response:** Configure the email system settings to enable error notifications, and resubmit the command.

---

**CMMVC6608E** The command cannot be initiated because Easy Tier is active on the virtual disk copy.

**Explanation:** Easy Tier is active on the volume copy, which prevents the success of the command.

**User response:** Disable Easy Tier on the volume copy or on the storage pool in which the volume copy resides, and resubmit the command.

---

**CMMVC6609E** The command cannot be initiated because the size of the Mdisk is smaller than the extent size of the MDisk group.

**Explanation:** The sizing of the Mdisk in relation to the storage pool is not correct, which prevents the success of the command.

**User response:** Use a larger Mdisk or make the extent size of the storage pool smaller than the Mdisk, and resubmit the command.

---

**CMMVC6610E** The software upgrade cannot start because one or more I/O groups are in maintenance mode.

**Explanation:** Maintenance mode is used during system servicing, which prevents software upgrades.

**User response:** Complete system servicing, turn off maintenance mode, and resubmit the command.

---

**CMMVC6611E** The command has failed because the specified enclosure is offline.

**Explanation:** The specified enclosure is offline, which has prevented the success of the command.

**User response:** Fix any errors associated with the specified enclosure, and resubmit the command.

---

**CMMVC6612E** The command has failed because of a hardware error.

**Explanation:** A hardware error has occurred, which has prevented the success of the command.

**User response:** Fix any errors in the specified object, and resubmit the command.

---

**CMMVC6613E** The command has failed because the specified enclosure type is not supported.

**Explanation:** You have attempted to use an enclosure of an unsupported type.

**User response:** Do not attempt to use the specified enclosure type.

---

**CMMVC6614E** The command has failed because the specified canister is offline.

**Explanation:** The specified canister is offline, which has prevented the success of the command.

**User response:** Fix any errors associated with the specified canister, and resubmit the command.

---

**CMMVC6615E** The command cannot be initiated because nodes from this enclosure cannot be added to the specified I/O group, or another enclosure is in the process of being added.

**Explanation:** The nodes in the enclosure being added are used elsewhere in the cluster, the target I/O group contains nodes of a different control enclosure, or another enclosure has not yet completed the process of being added.

**User response:** If a node already exists in the I/O group, add nodes from the same enclosure only. If the I/O group is empty, you can use a different control enclosure in which the nodes are not in a cluster. If you are currently adding another enclosure, wait for the completion of that process. Ensure that both nodes of an added enclosure are online and that the enclosure is listed in the output of the `lsenclosure` command.

---

**CMMVC6616E** All available quorum disks are dependent on the MDisks that you have specified.

**Explanation:** The list of MDisks that you have specified contains all activated quorum disks. If all of the MDisks in the list were to become inaccessible, the system would be unable to backup important data. Operating the system without any online quorum disks is not recommended.

**User response:** Move one or more quorum disks to MDisks that will remain online.

---

**CMMVC6617E** All available quorum disks are dependent on the drives that you have specified.

**Explanation:** The list of drives that you have specified contains all activated quorum disks. If all of the drives in the list were to become inaccessible, the system would be unable to backup important data. Operating the system without any online quorum disks is not recommended.

**User response:** Move one or more quorum disks to drives that will remain online.

---

**CMMVC6618E** All available quorum disks are dependent on the enclosure that you have specified.

**Explanation:** Before removing the enclosure that you have specified, the system must be configured so at least one of the drives that are allocated to hold quorum will remain online when the enclosure goes offline.

**User response:** Assign one or more drives in the control enclosure as a quorum drive. After you have configured the quorum drives, test for dependencies.

---

**CMMVC6619E** All available quorum disks are dependent on the canister that you have specified.

**Explanation:** Before removing the canister that you have specified, the system must be configured so at least one of the drives that are allocated to hold quorum will remain online when the canister goes offline.

**User response:** Assign one or more of the drives in the control enclosure as a quorum drive. After you have configured the quorum drives, test for dependencies.

---

**CMMVC6620E** The command cannot be initiated because the drives that you have specified are in different I/O groups.

**Explanation:** All of the specified drives that comprise the array must be in the same I/O group.

**User response:** Specify one or more drives in the same I/O group, and resubmit the command.

---

**CMMVC6621E** The command cannot be initiated because the array member that you have specified already exists.

**Explanation:** A drive has already been configured for the specified array member. You can use the `lsarraymember` command to display the available members of an array.

**User response:** Specify an array member without a corresponding drive, and resubmit the command.

---

**CMMVC6622E** The command cannot be initiated because the drive has failed validation tests.

**Explanation:** When a drive is made a candidate, the new drive is validated to ensure that adding it to the configuration will not adversely affect the existing or future array status. Either the current status of the drive has not allowed the validation to be performed, or the validation has failed.

**User response:** Fix any errors associated with the

specified drive, or specify a different drive, and resubmit the command.

---

**CMMVC6623E** The command cannot be initiated because the drive validation test has timed out.

**Explanation:** When a drive is made a candidate, the new drive is validated to ensure that adding it to the configuration will not adversely affect the existing or future array status. The test timed out, which caused the validation to fail.

**User response:** Fix any errors that are associated with the specified drive, or specify a different drive, and resubmit the command.

---

**CMMVC6624E** The command cannot be initiated because the drive is not in an appropriate state to perform the task.

**Explanation:** The drive that you have specified is offline. A format task is permitted to an offline drive only if the drive has indicated that a format is required and connectivity to the drive is available.

**User response:** Fix any errors that are associated with the specified drive, or specify a different drive, and resubmit the command.

---

**CMMVC6625E** The command cannot be initiated because a task is in progress on the drive.

**Explanation:** A drive can complete only one task at a time. A previous task remains uncompleted. You can monitor the progress of the task using the `lsdriveprogress` command.

**User response:** Wait for the previous task to complete, and resubmit the command.

---

**CMMVC6626E** The task was not initiated because a command was rejected by the drive that you have specified.

**Explanation:** When attempting to initiate a task, a sequence of commands is sent to the drive. One or more of these commands was rejected by the drive that you have specified.

**User response:** Fix any errors that are associated with the enclosure and cabling, and resubmit the command.

---

**CMMVC6627E** The enclosure that you have specified cannot be changed to managed mode because of a SAS configuration problem that is described in the event log.

**Explanation:** The status of the enclosure that you have specified will not allow the enclosure to be managed by the cluster.

**User response:** Ensure that the enclosure is online and cabled correctly, and resubmit the command.

---

**CMMVC6628E** The enclosure that you have specified cannot be changed to unmanaged mode because one or more drives are in use.

**Explanation:** The status of the enclosure that you have specified will not allow the enclosure to be unmanaged by the cluster.

**User response:** Stop using the drives, and resubmit the command.

---

**CMMVC6630E** A drive dump was not created because a command was rejected by the drive that you have specified.

**Explanation:** When initiating a drive dump, a sequence of commands is sent to the drive. One or more of these commands was rejected by the drive that you have specified.

**User response:** Fix any errors associated with the drive, enclosure, and cabling, or specify a different drive, and resubmit the command.

---

**CMMVC6631E** The task was not completed because the drive that you have specified was unavailable.

**Explanation:** The drive that you have specified did not have the required connectivity to complete the task.

**User response:** Fix any errors associated with the drive, or specify a different drive, and resubmit the command.

---

**CMMVC6988E** The command cannot be initiated because the maximum number of iSCSI qualified names (IQNs) for the cluster has been reached.

**Explanation:** The specified cluster is already configured with the maximum number of IQNs.

**User response:** None.

---

**CMMVC6998E** The command cannot be initiated because the maximum number of iSCSI qualified names (IQNs) for one or more I/O groups has been reached.

**Explanation:** One or more I/O groups are already configured with the maximum number of IQNs.

**User response:** None.



---

**CMMVC6999E** The command cannot be initiated because the maximum number of iSCSI qualified names (IQNs) for the host has been reached.

**Explanation:** The specified host is already configured with the maximum number of IQNs.

**User response:** None.

---

**CMMVC7003E** The command cannot be initiated because the power supply unit (PSU) that you have specified is offline.

**Explanation:** The power supply unit (PSU) that you specify must be online when you submit the command.

**User response:** Fix any errors associated with the specified PSU. Ensure that the PSU is online, and resubmit the command.

---

**CMMVC7005E** The command cannot be initiated because enclosures do not exist for the I/O group that you have specified.

**Explanation:** You have submitted a command and specified an I/O group that is not associated with an enclosure. You can submit the `lsenclosure` command to show all of the existing enclosures and their associated I/O groups.

**User response:** Specify an I/O group that is associated with an enclosure when you submit the command.

---

**CMMVC7010E** The command cannot be initiated because the MDisk mode is set to Array.

**Explanation:** This command requires the selected MDisk to be a SAN MDisk (an MDisk that is not an array made from local drives). The selected MDisk has its mode set to Array.

**User response:** Use `lsmdisk` to list the MDisks, and resubmit the command against an MDisk with a mode other than Array.

---

**CMMVC7011E** The array cannot be created because no quorum disks are currently configured.

**Explanation:** When creating an array, quorum disks are required to back up metadata for the array. Creating an array while no quorum disks are configured is not permitted. Quorum disks can be assigned to drives in the control enclosure automatically, or manually by using the `chquorum` command.

**User response:** Manage the control enclosure, and ensure that all drives within the enclosure are online before resubmitting the command.

---

**CMMVC7014E** The command cannot be initiated because one or more of the drives are not supported for this RAID level.

**Explanation:** Only certain RAID levels are supported in some configurations.

**User response:** Consult the configuration guide to determine supported RAID levels.

---

**CMMVC7015E** The command cannot be initiated because one or more of the drives are located in the wrong node.

**Explanation:** For RAID 0, all of the members must be located in the same node. For RAID 1 or RAID 10, mirrored pairs must be located in different nodes.

**User response:** Consult the configuration guide to determine which drives to use for the selected RAID level.

---

**CMMVC7016E** Authorization has failed because the private key is not valid for the user name that you have specified.

**Explanation:** The private key and user name that you have provided do not match what has been defined on the cluster.

**User response:** Ensure that the private key is valid for the specified user name, and log in again.

---

**CMMVC7017E** Login has failed because the maximum number of concurrent CLI sessions has been reached.

**Explanation:** The cluster supports up to 10 concurrent CLI sessions. The login attempt would have exceeded the supported limit.

**User response:** Reduce the number of open CLI sessions, and log in again.

---

**CMMVC7018E** The command failed because the requested VDisk size is too large.

**Explanation:** The system has a maximum size for virtual disks (VDisks) that is currently 256 TB. While creating a new VDisk or resizing an existing VDisk, you requested a VDisk size that exceeds the maximum.

**User response:** Resubmit the command with a smaller VDisk size.

---

**CMMVC7019E** The command failed because the VDisk size is not a multiple of 512 bytes.

**Explanation:** VDisk capacity must be a complete number of blocks, where one block is 512 bytes. While creating a new VDisk or resizing an existing VDisk,

## CMMVC7020E • CMMVC7028E

you requested a VDisk size that is an incomplete number of blocks.

**User response:** Resubmit the command with a valid VDisk size.

---

**CMMVC7020E** The command failed because the maximum number of VDIsks for this I/O group already exist.

**Explanation:** The system has a limit of VDIsks per I/O group. A new VDisk cannot be created in an I/O group that has already reached the limit of VDIsks.

**User response:** Choose another I/O group or delete some VDIsks in this I/O group.

---

**CMMVC7021E** The command failed because the maximum number of VDisk copies already exist.

**Explanation:** The system has a limit on the number of VDisk copies that can be created. An additional VDisk copy cannot be created because the limit has been reached.

**User response:** Delete some existing VDisk copies and resubmit the command.

---

**CMMVC7022E** The command failed because NTP is active.

**Explanation:** You have attempted to manually set the cluster time while the cluster is configured to use NTP (network time protocol) to set its time.

**User response:** Disable NTP, and resubmit the command. If you are trying to set the time manually because the cluster time is incorrect, check the settings on the NTP server.

---

**CMMVC7023E** The command failed because the requested node name is in use as the failover name of another node.

**Explanation:** You have attempted to add a node to a cluster or rename a node that is already in the cluster. The new name that you have requested for the node is not valid because one of the nodes in the cluster has been configured with the requested new name as its failover name.

**User response:** Either resubmit the command specifying a different node name, or modify the configuration of the node in the cluster to change its matching failover name to a different failover name.

---

**CMMVC7024E** The command failed because the maximum number of file systems already exist.

**Explanation:** The maximum number of file systems

has been reached. Additional file systems cannot be created.

**User response:** Remove an unused file system and reissue the command, or extend an existing file system by creating the VDisk there.

---

**CMMVC7025E** The command failed because the VDisk is associated with a file system and cannot be removed under your current user role.

**Explanation:** You are attempting to remove a VDisk that is associated with a file system. However, you do not possess the required role for file system actions and VDisk removal.

**User response:** Resubmit the task using the SONAS **remove VDisk** command.

---

**CMMVC7026E** The command failed because VDIsks exist in the file system.

**Explanation:** You are attempting to delete an MDisk group with which VDIsks are associated. The MDisk group cannot be removed while the associated VDIsks remain.

**User response:** Remove the file system VDIsks, and resubmit the command to remove the MDisk group.

---

**CMMVC7027E** The command failed because the requested action is not permitted on a VDisk that is in a file system.

**Explanation:** The VDisk that you have specified is associated with a file system, which disallows the requested action.

**User response:** The command cannot be completed on this VDisk. It will only succeed with a VDisk that is not associated with a file system.

---

**CMMVC7028E** The task cannot be completed because the FlashCopy target VDisk that you have specified is in a Metro Mirror or Global Mirror relationship, and the I/O group of the VDisk is different than that of the proposed FlashCopy mapping.

**Explanation:** The FlashCopy map must be in the same I/O group as the target VDisk because the VDisk is a component of a remote copy relationship.

**User response:** Specify the I/O group of the target VDisk when creating the FlashCopy map.

---

**CMMVC7029E** The task cannot be completed because one or more of the target VDisks of the FlashCopy mappings is the primary of a mirroring Metro Mirror or Global Mirror relationship.

**Explanation:** The target VDisk is part of a remote copy relationship that is active.

**User response:** Either force stop the FlashCopy consistency group or stop any remote copy relationships.

---

**CMMVC7030E** The task cannot be completed because the target VDisk of the FlashCopy mapping is the primary of a mirroring Metro Mirror or Global Mirror relationship.

**Explanation:** The target of the FlashCopy map is a component of an active FlashCopy map.

**User response:** Either force stop the FlashCopy map or stop the remote copy relationship.

---

**CMMVC7031E** The task cannot be completed because the FlashCopy mapping target VDisk is a secondary in a Metro Mirror or Global Mirror relationship, or is the primary in an active relationship.

**Explanation:** The target VDisk of the FlashCopy map is part of an active remote copy relationship.

**User response:** Stop the remote copy relationship.

---

**CMMVC7032E** The task cannot be completed because one or more of the target VDisks of the FlashCopy mappings is either a secondary in a Metro Mirror or Global Mirror relationship or the primary of an active relationship.

**Explanation:** A target VDisk of a FlashCopy map in the consistency group is part of an active remote copy relationship.

**User response:** Stop any remote relationships containing a target VDisk of a map in the consistency group.

---

**CMMVC7033E** The task failed because the current hardware configuration is not valid.

**Explanation:** You have issued the "chnodehw" command to enable new hardware that is faulty, unsupported, or incompletely installed.

**User response:** Follow service procedures as prompted by the management GUI to correct the hardware configuration. Then reissue the command.

---



---

**CMMVC7036E** The action failed because quorum is not permitted on the drive that you have specified.

**Explanation:** Quorum is only permitted on specific drive types. The drive that you have selected will not support quorum.

**User response:** Reissue the command specifying a different drive.

---

**CMMVC7037E** The action failed because the drive cannot be found.

**Explanation:** You have specified a drive does not appear to exist.

**User response:** Reissue the command specifying a different drive.

---

**CMMVC7038E** The action failed because the system was unable to initialize the quorum disk.

**Explanation:** A sequence of SCSI commands must be sent to a quorum disk before it can become available for use. One of these SCSI commands has failed.

**User response:** Fix any errors associated with the drive or MDisk, choose a different resource for quorum, then reissue the command.

---

**CMMVC7039E** The action failed because the specified drive is not online.

**Explanation:** The drive that you have specified is offline possibly as a result of errors.

**User response:** Fix any errors associated with the drive, or choose a different resource for quorum, then reissue the command.

---

**CMMVC7040E** The action failed because the specified MDisk is not online.

**Explanation:** The MDisk that you have specified is offline possibly as a result of errors.

**User response:** Fix any errors associated with the MDisk, or choose a different resource for quorum, then reissue the command.

---

**CMMVC7041E** The action failed because a better quorum candidate is available for use as quorum and override has not been enabled.

**Explanation:** Quorum disks are selected automatically based on a set of selection criteria. The resource that was selected is inferior to an alternative resource.

**User response:** Choose a different resource for quorum, or refer to the quorum documentation before

## CMMVC7042E • CMMVC7045E

using the **-override** parameter.

---

**CMMVC7042E** The action failed because the **-override yes** parameter was used without a specified drive or MDisk.

**Explanation:** The **-override yes** parameter must specify a drive or MDisk.

**User response:** Reissue the command with the correct syntax.

---

**CMMVC7043E** The action failed because the required extents could not be allocated.

**Explanation:** When an MDisk is specified for quorum, some extents must be allocated for use by the quorum disk. Sufficient extents were not available.

**User response:** Reissue the command using a different MDisk or migrate data from the MDisk to free up sufficient extents.

---

**CMMVC7044E** The action failed because the specified drive is either degraded or excluded.

**Explanation:** The drive that you have specified either contains errors or is in the Excluded state.

**User response:** Fix any errors associated with the drive, or choose a different resource for quorum, then reissue the command.

---

**CMMVC7045E** The action failed because the specified MDisk is either degraded or excluded.

**Explanation:** The MDisk that you have specified either contains errors or is in the Excluded state.

**User response:** Fix any errors associated with the MDisk, or choose a different resource for quorum, then reissue the command.

---

## Appendix. Accessibility

Accessibility features help a user who has a physical disability, such as restricted mobility or limited vision, to use software products successfully.

### Features

This list includes the major accessibility features in the management GUI:

- You can use screen-reader software and a digital speech synthesizer to hear what is displayed on the screen. The following screen reader has been tested: JAWS 11.
- Most of the GUI features are accessible by using the keyboard. For those features that are not accessible, equivalent function is available by using the command-line interface (CLI).
- When setting or changing an IP address on the SAN Volume Controller front panel, you can disable the fast increase function to reduce the address scrolling speed of the up and down buttons to two seconds. This feature is documented in the topic that discusses initiating cluster (system) creation from the front panel, which is located in the IBM System Storage SAN Volume Controller Information Center and the *IBM System Storage SAN Volume Controller Software Installation and Configuration Guide*.

### Navigating by keyboard

You can use keys or key combinations to perform operations and initiate many menu actions that can also be done through mouse actions. You can navigate the management GUI and help system from the keyboard by using the following key combinations:

- To navigate between different GUI panels, select the Low-graphics mode option on the GUI login panel. You can use this option to navigate to all the panels without manually typing the web addresses.
- To go to the next frame, press Ctrl+Tab.
- To move to the previous frame, press Shift+Ctrl+Tab.
- To navigate to the next link, button, or topic within a panel, press Tab inside a frame (page).
- To move to the previous link, button, or topic within a panel, press Shift+Tab.
- To select GUI objects, press Enter.
- To print the current page or active frame, press Ctrl+P.
- To expand a tree node, press the Right Arrow key. To collapse a tree node, press the Left Arrow key.
- To scroll all the way up, press Home; to scroll all the way down, press End.
- To go back, press Alt+Left Arrow key.
- To go forward, press Alt+Right Arrow key.
- For actions menus:
  - Press Tab to navigate to the grid header.
  - Press the Left or Right Arrow keys to reach the drop-down field.
  - Press Enter to open the drop-down menu.
  - Press the Up or Down Arrow keys to select the menu items.
  - Press Enter to launch the action.
- For filter panes:
  - Press Tab to navigate to the filter panes.
  - Press the Up or Down Arrow keys to change the filter or navigation for nonselection.
  - Press Tab to navigate to the magnifying glass icon in the filter pane and press Enter.
  - Type the filter text.

- Press Tab to navigate to the red X icon and press Enter to reset the filter.
- For information areas:
  - Press Tab to navigate to information areas.
  - Press Tab to navigate to the fields that are available for editing.
  - Type your edit and press Enter to issue the change command.

## **Accessing the publications**

You can find the HTML version of the IBM System Storage SAN Volume Controller information at the following website:

[publib.boulder.ibm.com/infocenter/svc/ic/index.jsp](http://publib.boulder.ibm.com/infocenter/svc/ic/index.jsp)

You can access this information using screen-reader software and a digital speech synthesizer to hear what is displayed on the screen. The information was tested using the following screen reader: JAWS Version 10 or later.

---

## Notices

This information was developed for products and services offered in the U.S.A.

IBM may not offer the products, services, or features discussed in this document in other countries. Consult your local IBM representative for information on the products and services currently available in your area. Any reference to an IBM product, program, or service is not intended to state or imply that only that IBM product, program, or service may be used. Any functionally equivalent product, program, or service that does not infringe any IBM intellectual property right may be used instead. However, it is the user's responsibility to evaluate and verify the operation of any non-IBM product, program, or service.

IBM may have patents or pending patent applications covering subject matter described in this document. The furnishing of this document does not give you any license to these patents. You can send license inquiries, in writing, to:

*IBM Director of Licensing  
IBM Corporation  
North Castle Drive  
Armonk, NY 10504-1785  
U.S.A.*

For license inquiries regarding double-byte (DBCS) information, contact the IBM Intellectual Property Department in your country or send inquiries, in writing, to:

*Intellectual Property Licensing  
Legal and Intellectual Property Law  
IBM Japan, Ltd.  
1623-14, Shimotsuruma, Yamato-shi  
Kanagawa 242-8502 Japan*

**The following paragraph does not apply to the United Kingdom or any other country where such provisions are inconsistent with local law:** INTERNATIONAL BUSINESS MACHINES CORPORATION PROVIDES THIS PUBLICATION "AS IS" WITHOUT WARRANTY OF ANY KIND, EITHER EXPRESS OR IMPLIED, INCLUDING, BUT NOT LIMITED TO, THE IMPLIED WARRANTIES OF NON-INFRINGEMENT, MERCHANTABILITY OR FITNESS FOR A PARTICULAR PURPOSE. Some states do not allow disclaimer of express or implied warranties in certain transactions, therefore, this statement may not apply to you.

This information could include technical inaccuracies or typographical errors. Changes are periodically made to the information herein; these changes will be incorporated in new editions of the publication. IBM may make improvements and/or changes in the product(s) and/or the program(s) described in this publication at any time without notice.

Any references in this information to non-IBM websites are provided for convenience only and do not in any manner serve as an endorsement of those websites. The materials at those websites are not part of the materials for this IBM product and use of those websites is at your own risk.

IBM may use or distribute any of the information you supply in any way it believes appropriate without incurring any obligation to you.

Licensees of this program who wish to have information about it for the purpose of enabling: (i) the exchange of information between independently created programs and other programs (including this one) and (ii) the mutual use of the information which has been exchanged, should contact:

*IBM Corporation  
Almaden Research  
650 Harry Road  
Bldg 80, D3-304, Department 277  
San Jose, CA 95120-6099  
U.S.A.*

Such information may be available, subject to appropriate terms and conditions, including in some cases, payment of a fee.

The licensed program described in this document and all licensed material available for it are provided by IBM under terms of the IBM Customer Agreement, IBM International Program License Agreement or any equivalent agreement between us.

Any performance data contained herein was determined in a controlled environment. Therefore, the results obtained in other operating environments may vary significantly. Some measurements may have been made on development-level systems and there is no guarantee that these measurements will be the same on generally available systems. Furthermore, some measurement may have been estimated through extrapolation. Actual results may vary. Users of this document should verify the applicable data for their specific environment.

Information concerning non-IBM products was obtained from the suppliers of those products, their published announcements or other publicly available sources. IBM has not tested those products and cannot confirm the accuracy of performance, compatibility or any other claims related to non-IBM products. Questions on the capabilities of non-IBM products may be addressed to the suppliers of those products.

All statements regarding IBM's future direction or intent are subject to change or withdrawal without notice, and represent goals and objectives only.

This information is for planning purposes only. The information herein is subject to change before the products described become available.

This information contains examples of data and reports used in daily business operations. To illustrate them as completely as possible, the examples include the names of individuals, companies, brands, and products. All of these names are fictitious and any similarity to the names and addresses used by an actual business enterprise is entirely coincidental.

#### COPYRIGHT LICENSE:

This information contains sample application programs in source language, which illustrate programming techniques on various operating platforms. You may copy, modify, and distribute these sample programs in any form without payment to IBM, for the purposes of developing, using, marketing or distributing application programs conforming to the application programming interface for the operating platform for which the sample programs are written. These examples have not been thoroughly tested under all conditions. IBM, therefore, cannot guarantee or imply reliability, serviceability, or function of these programs. The sample programs are provided "AS IS", without warranty of any kind. IBM shall not be liable for any damages arising out of your use of the sample programs.

If you are viewing this information softcopy, the photographs and color illustrations may not appear.



---

## Trademarks

IBM, the IBM logo, and [ibm.com](http://ibm.com) are trademarks or registered trademarks of International Business Machines Corp., registered in many jurisdictions worldwide. Other product and service names might be trademarks of IBM or other companies. A current list of IBM trademarks is available on the web at [www.ibm.com/legal/copytrade.shtml](http://www.ibm.com/legal/copytrade.shtml).

Adobe and the Adobe logo are either registered trademarks or trademarks of Adobe Systems Incorporated in the United States, and/or other countries.

Intel, Intel logo, Intel Xeon, and Pentium are trademarks or registered trademarks of Intel Corporation or its subsidiaries in the United States and other countries.

Linux is a registered trademark of Linus Torvalds in the United States, other countries, or both.

Microsoft, Windows, Windows NT, and the Windows logo are trademarks of Microsoft Corporation in the United States, other countries, or both.

UNIX is a registered trademark of The Open Group in the United States and other countries.

Java and all Java-based trademarks and logos are trademarks or registered trademarks of Oracle and/or its affiliates.

Other product and service names might be trademarks of IBM or other companies.



---

# Index

## Special characters

-filtervalue argument xxx

## A

- about this document
  - sending comments xx
- accessibility
  - keyboard 509
  - repeat rate
  - up and down buttons 509
  - shortcut keys 509
- accessing
  - publications 509
- addcontrolenclosure command 163
- addhostiogrps command 197
- addhostport command 197
- adding
  - nodes 14
- addmdisk command 323
- addnode command 102
- addvdiskcopy command 397
- applydrivesoftware command 141
- applymdisksoftware command 317
- applysoftware command 127, 365
- array commands
  - charray 77
  - charraymember 77
  - lsarray 80
  - lsarrayinitprogress 83
  - lsarraylba 84
  - lsarraymember 84
  - lsarraymembergoals 86
  - lsarraymemberprogress 88
  - lsarraysyncprogress 89
  - mkarray 90
  - overview 77
  - recoverarray 91
  - recoverarraybycluster 91
  - rmarray 92
- audit log commands
  - catauditlog 93
  - dumpauditlog 94
  - lsauditlogdumps 95
  - overview 93
- authentication
  - SSH logins 1

## B

- backup and restore commands 97
- backup command 97
- backup commands
  - backup 97
  - clear 98
  - help 98

## C

- cancellivedump command 313
- catauditlog command 93
- caterrlog command 128
- caterrlogbyseqnum command 128
- cfgportip command 104
- changing
  - passwords 70
- charray command 77
- charraymember command 77
- chauthservice command 387
- chcluster command 106
- chclusterip command 108
- chcontroller commands 139
- chcurrentuser command 389
- chdrive command 141
- chemail command 148
- chemailserver command 149
- chemailuser command 150
- chenclosure command 163
- chenclosurecanister command 164
- chenclosureslot command 165
- chenclosurevpd command 369
- cherrstate command 128
- chfcconsistgrp command 181
- chfcmap command 181
- chhost command 198
- chiogrp command 110
- chlicense command 177
- chmdisk command 317
- chmdiskgrp command 324
- chnode command 112
- chnodehw command 114
- chnodeled command 370
- chpartnership command 331
- chquorum command 318
- chrconsistgrp command 332
- chrrelationship command 332
- chserviceip command 370
- chsnmpserver command 151
- chsyslogserver command 152
- chuser command 390
- chusergrp command 391
- chvdisk command 401
- chwwnn command 372
- clear command 98
- cleardumps command 114, 365
- clearerrlog command 129
- CLI (command-line interface)
  - configuring PuTTY 3
  - getting started 11
  - preparing SSH client on AIX or Linux 6
  - preparing SSH client on Windows 1
  - using to update clustered system license 12
- CLI commands
  - chcluster
    - changing clustered system gateway address 61

CLI commands (*continued*)

- chcluster (*continued*)
  - changing relationship
    - bandwidth 61
    - modifying cluster (system) IP address 60
- chcurrentuser 66
- chfcmap 32
- chlicense 12
- chuser 66
- chusergrp 65
- lscluster
  - changing clustered system gateway address 61
  - changing relationship
    - bandwidth 61
    - displaying clustered system properties 12
    - modifying cluster (system) IP address 60
- lscurrentuser 66
- lsfcconsistgrp 32, 33
- lsfcmap 30, 32
- lslicense 12
- lsuser 66
- lsusergrp 65
- lsvdisk 30
- mkfcconsistgrp 32
- mkfcmap 30
- mkuser 66
- mkusergrp 65
- prestartfcconsistgrp 33
- rmuser 66
- rmusergrp 65
- setlocale 70
- startfcconsistgrp 33

cluster

- configuring for iSCSI 61

cluster commands

- cfgportip 104
- chiogrp 110
- chnode 112
- cleardumps 114
- cpdumps 115
- rmnode 119
- rmportip 121
- settetimezone 123
- startstats 123
- stopstats 127

cluster diagnostic and service-aid commands

- cherrstate 128
- dumperrlog 129
- finderr 130
- overview 127
- writesernum 138

cluster error log

- displaying 128

- clustered system
  - authentication
    - configuring clustered system
      - iSCSI 64
    - configuring iSCSI authentication 64
    - recovering nodes 48
  - clustered system commands
    - addnode 102
    - chcluster 106
    - chclusterip 108
    - detectmdisk 117
    - mkcluster 375
    - ping 118
    - setclustertime 121
    - setpwdreset 122
    - stopcluster 125
  - clustered system diagnostic and service-aid commands
    - applysoftware 127
    - clearerrlog 129
    - setlocale 136
    - svqueryclock 137
  - clustered systems
    - configuring iSCSI alias 63
    - deleting nodes 57
    - gateway address
      - changing 61
    - modifying iSCSI alias 63
    - properties 12
    - removing nodes 57
    - shutting down 71
    - updating
      - license 12
    - viewing
      - license 12
  - clusters
    - error logs 71
    - logs 71
    - viewing feature logs 71
  - command 145
  - command-line interface (CLI)
    - configuration 2
    - configuring PuTTY 3
    - getting started 11
    - preparing SSH clients on AIX or Linux 6
    - preparing SSH clients on Windows 1
    - using to update clustered system
      - license 12
    - using to view clustered system
      - license 12
  - Command-Line Interface User's Guide GC27-2287-01, Summary of changes for xi
  - commands
    - addcontrolenclosure 163
    - addhostiogrp 197
    - addhostport 197
    - addmdisk 323
    - addnode 102
    - addvdiskcopy 397
    - applydrivesoftware 141
    - applydisksoftware 317
    - applysoftware 127, 365
    - backup 97
    - cancellivedump 313
    - catauditlog 93
  - commands (*continued*)
    - caterrlog 128
    - caterrlogbyseqnum 128
    - cfgportip 104
    - charray 77
    - charraymember 77
    - chauthservice 387
    - chcluster 106
    - chclusterip 108
    - chcontroller 139
    - chcurrentuser 389
    - chdrive 141
    - chemail 148
    - chemailserver 149
    - chemailuser 150
    - chenclosure 163
    - chenclosurecanister 164
    - chenclosureslot 165
    - chenclosurevpd 369
    - cherrstate 128
    - chfcconsistgrp 181
    - chfcmap 181
    - chhost 198
    - chiogrp 110
    - chlicense 177
    - chmdisk 317
    - chmdiskgrp 324
    - chnode 112
    - chnodehw 114
    - chnodeled 370
    - chpartnership 331
    - chquorum 318
    - chrconsistgrp 332
    - chrrelationship 332
    - chserviceip 370
    - chsnmpserver 151
    - chsyslogserver 152
    - chuser 390
    - chusergrp 391
    - chvdisk 401
    - chwwnn 372
    - clear 98
    - clear.dumps 114, 365
    - clearerrlog 129
    - cp.dumps 115
    - cpfiles 372
    - detectmdisk 117
    - dumpallmdiskbadblocks 319
    - dumpauditlog 94
    - dumperrlog 129, 365
    - dumpinternallog 179
    - dumpmdiskbadblocks 320
    - exit 367
    - expandvdisksize 404
    - finderr 130
    - help 98
    - includemdisk 321
    - installsoftware 373
    - leavecluster 374
    - ls2145.dumps 205, 367
    - lsarray 80
    - lsarrayinitprogress 83
    - lsarraylba 84
    - lsarraymember 84
    - lsarraymembergoals 86
    - lsarraymemberprogress 88
    - lsarraysyncprogress 89
  - commands (*continued*)
    - lsauditlog.dumps 95
    - lscimom.dumps 205, 367
    - lscluster 206
    - lsclustercandidate 210
    - lsclusterip 211
    - lsclustervpd 367
    - lscmdstatus 353
    - lscontrolenclosurecandidate 169
    - lscontroller 213
    - lscontrollerdependentvdisks 215
    - lscopystatus 205
    - lscurrentuser 216
    - lsdependentvdisks 308
    - lsdiscoverystatus 217
    - lsdrive 142
    - lsdrivelba 144
    - ls.dumps 217
    - lsemailserver 219
    - lsemailuser 220
    - lsclosure 166
    - lsclosurebattery 168
    - lsclosurecanister 170
    - lsclosurerepsu 172
    - lsclosureslot 173
    - lserrlogbyfcconsistgrp 131
    - lserrlogbyfcmap 131
    - lserrlogbyhost 131
    - lserrlogbyiogrp 131
    - lserrlogbymdisk 131
    - lserrlogbymdiskgrp 131
    - lserrlogbynode 131
    - lserrlogbyrconsistgrp 131
    - lserrlogbyrrelationship 131
    - lserrlogbyvdisk 131
    - lserrlog.dumps 131, 367
    - lseventlog 131
    - lsfabric 221
    - lsfcconsistgrp 222
    - lsfcmap 224
    - lsfcmapcandidate 227
    - lsfcmapdependentmaps 228
    - lsfcmapprogress 227
    - lsfeaturedumps 229, 367
    - lsfiles 353
    - lsfreeextents 229
    - lshardware 354
    - lshbaportcandidate 230
    - lshost 231
    - lshostiogrp 233
    - lshostvdiskmap 234
    - lsiogrp 235
    - lsiogrpcandidate 238
    - lsiogrpghost 237
    - lsiostats.dumps 239, 367
    - lsiotracedumps 239, 367
    - lsscsiauth 239
    - lslicense 240
    - lslivedump 313, 314
    - lsmdisk 241
    - lsmdiskcandidate 247
    - lsmdisk.dumps 246, 367
    - lsmdiskextent 248
    - lsmdiskgrp 250
    - lsmdisklba 246
    - lsmdiskmember 253
    - lsmigrate 255

commands (continued)

- lsnode 256
- lsnodecandidate 262
- lsnodependentvdisks 263
- lsnodehw 260
- lsnodestats 263
- lsnodevpd 264, 368
- lspart 268
- lsquorum 270
- lsrconsistgrp 271
- lsrrelationship 274
- lsrrelationshipcandidate 276
- lsrrelationshipprogress 277
- lsrepairsevdiskcopyprogress 278
- lsrepairvdiskcopyprogress 280
- lsrmvdiskdependentmaps 281
- lsroute 282
- lsservicenodes 357
- lsservicecommendation 359
- lsservicestatus 359
- lssevdiskcopy 282
- lssnmpserver 286
- lssoftware.dumps 287, 369
- lssoftwareupgradestatus 287
- lssyslogserver 135
- lstimezones 287
- lsuser 288
- lsusergp 289
- lsvdisk 291
- lsvdiskcopy 296
- lsvdiskdependentmaps 299
- lsvdiskextent 300
- lsvdiskfcmappings 301
- lsvdiskfcmappings 302
- lsvdiskhostmap 303
- lsvdisklba 304
- lsvdiskmember 305
- lsvdiskprogress 307
- lsvdisksyncprogress 307
- metadata 375
- migrateexts 349
- migratetoimage 350
- migratevdisk 351
- mkarray 90
- mkcluster 375
- mkemailserver 153
- mkemailuser 154
- mkfcconsistgrp 183
- mkfcmap 184
- mkhost 200
- mkmdiskgrp 325
- mkpartnership 334
- mkrcconsistgrp 335
- mkrcrelationship 336
- mksnmpserver 156
- mksyslogserver 157
- mkuser 392
- mkusergrp 393
- mkvdisk 406
- mkvdiskhostmap 413
- ping 118
- prestartfcconsistgrp 186, 190
- prestartfcmap 187
- recoverarray 91
- recoverarraybycluster 91
- recovervdisk 414
- recovervdiskbycluster 415

commands (continued)

- recovervdiskbyiogrp 415
- repairsevdiskcopy 416
- repairvdiskcopy 417
- rescue node 376
- resetleds 377
- resetpassword 377
- restartservice 377
- restore 99
- rmarray 92
- rmemailserver 158
- rmemailuser 158
- rmfcconsistgrp 188
- rmfcmap 189
- rmhost 201
- rmhostiogrp 202
- rmhostport 203
- rmmdisk 327
- rmmdiskgrp 328
- rmnode 119
- rmpartnership 338
- rmporttip 121
- rmrcconsistgrp 338
- rmrcrelationship 339
- rmsnmpserver 159
- rmsyslogserver 159
- rmuser 394
- rmusergrp 394
- rmvdisk 418
- rmvdiskcopy 420
- rmvdiskhostmap 420
- sendinventoryemail 160
- service information 353
- service task 369
- setclustertime 121
- setdisktrace 383
- setlocale 136
- setpacedccu 378
- setpwdreset 122
- setquorum 322
- settempsshkey 379
- settimezone 123
- settrace 384
- showtimezone 311
- shrinkvdisksize 421
- snap 378
- splitvdiskcopy 423
- startemail 160
- startfcconsistgrp 190
- startfcmap 191
- startrcconsistgrp 340
- startrcrelationship 342
- startservice 379
- startstats 123
- starttrace 386
- stopcluster 125
- stopemail 161
- stopfcconsistgrp 192
- stopfcmap 194
- stopnode 380
- stoprcconsistgrp 344
- stoprcrelationship 345
- stopservice 381
- stopstats 127
- stoptrace 386
- svqueryclock 137
- switchrcconsistgrp 346

commands (continued)

- switchrcrelationship 347
- t3recovery 381
- testemail 161
- triggerenclosedump 175
- triggerlivedump 314
- triggermddiskdump 323
- writesernum 138
- comments, sending xx
- communications
  - determining between hosts and virtual disks 41
- configuring
  - iSNS server address 63
  - PuTTY 3
  - remote authentication service using CLI 64
- Connecting to the CLI using OpenSSH 7
- consistency group
  - deleting FlashCopy 35
  - stoppingFlashCopy 34
- consistency groups, Global Mirror
  - creating 37
  - deleting 38
  - modifying 38
  - starting and stopping 38
- consistency groups, Metro Mirror
  - creating 37
  - deleting 38
  - modifying 38
  - starting and stopping 38
- controller commands
  - chcontroller 139
  - overview 139
- controllers
  - changing 139
  - command 139, 213
- cpdumps command 115
- cpfiles command 372
- creating
  - volume-to-host mappings 29
- creating users 7
- current time zone 311

## D

- data migration progress
  - viewing 255
- deleting
  - nodes 57
- dependent maps
  - viewing 228
- detectmddisk command 117
- determining
  - communications between hosts and virtual disks 41
- diagnostic and service-aid commands
  - clearerrlog
    - clustered system 129
  - cluster 127
    - cherrstate 128
    - svqueryclock 137
    - writesernum 138
  - clustered system
    - applysoftware 127
    - setlocale 136

- diagnostic and service-aid commands
  - (continued)
  - dumperrlog
    - cluster 129
  - finderr
    - cluster 130
    - overview 127
- discovering
  - managed disks 18
- disks
  - migrating 54
  - migrating image mode 57
- documentation
  - improvement xx
- drive commands
  - applydrivesoftware 141
  - chdrive 141
  - lsdrive 142
  - lsdrivelba 144
  - overview 141
- dump files
  - listing 205, 367
  - lsfeaturedumps 229
- dumpallmdiskbadblocks command 319
- dumpauditlog command 94
- dumperrlog command 129, 365
- dumpinternallog command 179
- dumpmdiskbadblocks command 320

**E**

- email
  - inventory reports 69
  - setting up event notification 69
- email and event notification commands
  - chemailserver 149
  - chsnmpserver 151
  - chsyslogserver 152
  - mkemailserver 153
  - mksnmpserver 156
  - mksyslogserver 157
  - rmemailserver 158
  - rmsnmpserver 159
  - rmsyslogserver 159
- email commands
  - chemail 148
  - chemailuser 150
  - lsemailuser 220
  - mkemailuser 154
  - overview 147
  - rmemailuser 158
  - sendinventoryemail 160
  - startemail 160
  - stopemail 161
  - testemail 161
- email servers
  - setting up
    - CLI 70
- enclosure commands
  - lsclosure 166
  - lsclosurecanister 170
  - lsclosurepsu 172
  - lsclosureslot 173
  - overview 163
- error log dump files
  - viewing 367

- error notification
  - SYSLOG 68
- event notification commands
  - overview 147
- exit command 367
- expanding
  - virtual disks 50
- expandvdisksize command 404
- extent allocation
  - viewing 248
- extents
  - migrating
    - using the CLI (command-line interface) 53

## F

- featurization settings 240
- filtering
  - FlashCopy
    - consistency groups 222
    - mappings 224, 281, 299, 301
- finderr command 130
- FlashCopy
  - consistency group
    - deleting using CLI 35
    - stopping using CLI 34
  - consistency groups
    - creating using CLI 32
    - preparing using the CLI 33
    - starting using the CLI 33
  - deleting consistency group 35
  - deleting mapping 32
  - mapping
    - deleting using CLI 32
    - stopping 31
  - mappings
    - adding to consistency group 32
    - creating using CLI 30
  - memory 23
  - stopping consistency group 34
- FlashCopy commands
  - chfcconsistgrp 181
  - chfcmap 181
  - mkfcconsistgrp 183
  - mkfcmap 184
  - overview 181
  - prestartfcconsistgrp 186, 190
  - prestartfcmap 187
  - rmfcconsistgrp 188
  - rmfcmap 189
  - startfcconsistgrp 190
  - startfcmap 191
  - stopfcconsistgrp 192
  - stopfcmap 194
- FlashCopy progress 227
- free extents 229
- front panel
  - password 13

## G

- gateway address
  - changing 61
- Generating an SSH key pair using
  - OpenSSH 7

- getting started
  - using the CLI (command-line interface) 11
  - using the command-line interface (CLI) 11
- Global Mirror
  - memory 23
- Global Mirror commands
  - chpartnership 331
  - chrconsistgrp 332
  - chrrelationship 332
  - mkpartnership 334
  - mkrconsistgrp 335
  - mkrrelationship 336
  - overview 331
  - rmpartnership 338
  - rmrconsistgrp 338
  - rmrrelationship 339
  - startrcconsistgrp 340
  - startrcrelationship 342
  - stoprcconsistgrp 344
  - stoprcrelationship 345
  - switchchrconsistgrp 346
  - switchchrrelationship 347

## H

- help command 98
- host bus adaptor, unconfigured
  - viewing 230
- host commands
  - addhostigrp 197
  - addhostport 197
  - chhost 198
  - mkhost 200
  - overview 197
  - rmhost 201
  - rmhostigrp 202
  - rmhostport 203
- host I/O group 233
- host objects
  - configuring using CLI 28
- hosts
  - commands 197
  - determining VDisk names 41
  - mapping volumes 29
  - viewing 231

## I

- image mode volumes
  - converting to managed mode
    - using CLI (command-line interface) 56
- includemdisk command 321
- information
  - center xviii
- information commands 281, 301
  - addcontrolenclosure 163
  - caterrlog 128
  - caterrlogbyseqnum 128
  - chenclosure 163
  - chenclosurecanister 164
  - chenclosureslot 165
  - ls2145dumps 205
  - lscimomdumps 205



- lslicense command 240
- lslivedump command 313, 314
- lsmdisk command 241
- lsmdiskcandidate command 247
- lsmdiskdumps command 246, 367
- lsmdiskextent command 248
- lsmdiskgrp command 250
- lsmdisklba command 246
- lsmdiskmember command 253
- lsmigrate command 255
- lsnode command 256
- lsnodecandidate command 262
- lsnodependentvdisks command 263
- lsnodehw command 260
- lsnodestats command 263
- lsnodevpd command 264, 368
- lsportip command 268
- lsquorum command 270
- lsrconsistgrp command 271
- lsrrelationship command 274
- lsrrelationshipcandidate command 276
- lsrrelationshipprogress command 277
- lsrepairsevdiskcopyprogress command 278
- lsrepairvdiskcopyprogress command 280
- lsrmvdiskdependentmaps command 281
- lsroute command 282
- lsservicenodes command 357
- lsservicerecommendation command 359
- lsservicestatus command 359
- lssevdiskcopy command 282
- lssnmpserver command 286
- lssoftware.dumps command 287, 369
- lssoftwareupgradestatus command 287
- lssyslogserver command 135
- lstimezones command 287
- lsuser command 288
- lsusergrp command 289
- lsvdisk command 291
- lsvdiskcopy command 296
- lsvdiskdependentmaps command 299
- lsvdiskextent command 300
- lsvdiskfcmappcopies command 301
- lsvdiskfcmappings command 302
- lsvdiskhostmap command 303
- lsvdisklba command 304
- lsvdiskmember command 305
- lsvdiskprogress command 307
- lsvdisksyncprogress command 307

## M

- maintaining
  - passwords 13
- managed disk commands
  - applydisksoftware 317
  - chmdisk 317
  - chquorum 318
  - includemdisk 321
  - lsquorum 270
  - overview 317
  - setquorum 322
  - triggermdiskdump 323
- managed disk group commands
  - addmdisk 323
  - chmdiskgrp 324

- managed disk group commands
  - (continued)
  - mkmdiskgrp 325
  - overview 323
  - rmmdisk 327
  - rmmdiskgrp 328
- managed disks
  - viewing disks 241, 246
  - viewing groups 250
- managed disks (MDisks)
  - adding 21
  - discovering 18
  - rebalancing access 18
  - volume relationships 42
- managed mode virtual disks
  - converting from image mode
    - using the CLI (command-line interface) 56
- mapping
  - deleting FlashCopy 32
- master console
  - configuration 2
- MDisk commands
  - dumpallmdiskbadblocks 319
  - dumpmdiskbadblocks 320
- MDisks (managed disks)
  - adding 21
  - volume relationships 42
- MDisks *See* managed disks 317, 323
- metadata command 375
- Metro Mirror
  - memory 23
- Metro Mirror commands
  - chpartnership 331
  - chrconsistgrp 332
  - chrrelationship 332
  - mkpartnership 334
  - mkrconsistgrp 335
  - mkrrelationship 336
  - overview 331
  - rmpartnership 338
  - rmrconsistgrp 338
  - rmrrelationship 339
  - startrrconsistgrp 340
  - startrrrelationship 342
  - stoprrconsistgrp 344
  - stoprrrelationship 345
  - switchrrconsistgrp 346
  - switchrrrelationship 347
- migrateexts command 349
- migratetoimage command 350
- migratevdisk command 351
- migrating
  - volumes 44
- migratingvolumes
  - extents
    - using the CLI (command-line interface) 53
- migration 349
- migration commands
  - migrateexts 349
  - migratetoimage 350
  - migratevdisk 351
  - overview 349
- mkarray command 90
- mkcluster command 375
- mkemailserver command 153

- mkemailuser command 154
- mkfconsistgrp command 183
- mkfcmmap command 184
- mkhost commands 200
- mkmdiskgrp command 325
- mkpartnership command 334
- mkrconsistgrp command 335
- mkrrelationship command 336
- mksnmpserver command 156
- mksyslogserver command 157
- mkuser command 392
- mkusergrp command 393
- mkvdisk commands 406
- mkvdiskhostmap command 413

## N

- nodes
  - adding 14, 102
  - addnode command 102
  - changing 112
  - chnode command 112
  - deleting 57, 119
  - removing 57
  - returning to clustered system 48
  - rmnode command 119
  - statistics 263
  - viewing 256
    - general details 17

## O

- OpenSSH, Connecting to the CLI
  - using 7
- OpenSSH, Generating an SSH key pair
  - using 7
- overview
  - array commands 77
  - audit log commands 93
  - backup and restore commands 97
  - cluster commands 101
  - cluster diagnostic and service-aid
    - commands 127
  - controller commands 139
  - drive commands 141
  - dumps commands 75
  - email commands 147
  - enclosure commands 163
  - event notification commands 147
  - FlashCopy commands 181
  - host commands 197
  - information commands 205
  - licensing commands 177
  - managed disk commands 317
  - managed disk group commands 323
  - migration commands 349
  - secure shell 1
  - service mode commands 365
  - service mode information
    - commands 367
  - tracing commands 383
  - user management commands 387



## P

- partnerships, Global Mirror
  - creating 39
  - deleting 40
  - modifying 39
  - starting and stopping 39
- partnerships, Metro Mirror
  - creating 39
  - deleting 40
  - modifying 39
  - starting and stopping 39
- passwords
  - changing 70
  - front panel 13
- ping command 118
- plink utility
  - running 4
- port IP addresses
  - configuring 61
- prestartfcconsistgrp command 186
- prestartfcmap command 187
- publications
  - accessing 509
- PuTTY
  - configuring 3
  - generating an SSH key pair 2
  - running the plink utility 4
  - scp (pscp) 9
- PuTTY session
  - configuring for the CLI 3

## Q

- quorum disks
  - setting with CLI 22

## R

- reader feedback, sending xx
- rebalancing
  - managed disks (MDisks) access 18
- recoverarray command 91
- recoverarraybycluster command 91
- recovering
  - offline volumes
    - using CLI 47
- recovervdisk command 414
- recovervdiskbycluster command 415
- recovervdiskbyigrp command 415
- related information xviii
- relationships, Global Mirror
  - creating 35
  - deleting 37
  - displaying 36
  - modifying 35
  - starting and stopping 36
  - switching 37
- relationships, Metro Mirror
  - creating 35
  - deleting 37
  - displaying 36
  - modifying 35
  - starting and stopping 36
  - switching 37
- remote authentication
  - configuring using CLI 64

- removing
  - nodes 57
- repairing
  - space-efficient volume 46
- repairsevdiskcopy command 416
- repairvdiskcopy command 417
- rescuenode command 376
- resetleds command 377
- resetpassword command 377
- restartservice command 377
- restore command 99
- restore commands
  - clear 98
  - help 98
  - restore 99
- rmarray command 92
- rmemailserver command 158
- rmemailuser command 158
- rmfcconsistgrp command 188
- rmfcmap command 189
- rmhost command 201
- rmhostiogrps command 202
- rmhostport command 203
- rmmdisk command 327
- rmmdiskgrp command 328
- rmnode command 119
- rmpartnership command 338
- rmportip command 121
- rmrcconsistgrp command 338
- rmrelationship command 339
- rmsnmpserver command 159
- rmsyslogserver command 159
- rmuser command 394
- rmusergrp command 394
- rmvdisk command 418
- rmvdiskcopy command 420
- rmvdiskhostmap command 420
- running
  - PuTTY plink utility 4

## S

- SAN Volume Controller
  - front panel password 13
  - properties 17
- SAN Volume Controller library
  - related publications xviii
- scanning
  - Fibre Channel network 18
  - rebalancing MDisk access 18
- scp
  - PuTTY application 9
- secure shell
  - PuTTY 3
- secure shell (SSH)
  - authenticating logins 1
  - client
    - AIX or Linux 6
    - Windows 1
  - creating keys 2
  - overview 1
- secure shell client
  - preparing for CLI on AIX 6
  - preparing for CLI on Linux 6
- security 1
- sending
  - comments xx

- sendinventoryemail command 160
- service commands
  - chenclosurevdpd 369
  - chnodeled 370
  - chserviceip 370
  - chwwnn 372
  - installsoftware 373
  - leavecluster 374
  - lscmdstatus 353
  - lsfiles 353
  - lsservicenodes 357
  - lsservicerecommendation 359
  - lsservicestatus 359
  - metadata 375
  - rescuenode 376
  - resetpassword 377
  - restartservice 377
  - setpacedccu 378
  - settempsshkey 379
  - snap 378
  - startservice 379
  - stopnode 380
  - stopservice 381
  - t3recovery 381
- service information commands 353
- service mode
  - commands 365
  - information commands 367
- service mode commands
  - applysoftware 365
  - cleardumps 365
  - dumperrlog 365
  - exit 367
  - overview 365
- service mode information commands
  - ls2145dumps 367
  - lscimomdumps 367
  - lsclustervpd 367
  - lserrlogdumps 367
  - lsfeaturedumps 367
  - lsiostatsdumps 367
  - lsiotracedumps 367
  - lsmdiskdumps 367
  - lsnodevdpd 368
  - lssoftwaredumps 369
  - overview 367
- service task commands 369
  - cpfiles 372
- setclustertime command 121
- setdisktrace command 383
- setlocale command 136
- setpacedccu command 378
- setpwdreset command 122
- setquorum command 322
- settempsshkey command 379
- settimezone command 123
- setting
  - quorum disks 22
- settings
  - email server 70
  - error notification 68
  - event notification 67
- settrace command 384
- shortcut keys
  - accessibility 509
  - keyboard 509
- showtimezone command 311

- shrinkvdisksize command 52, 421
- snap command 378
- SNMP traps 67
- software
  - upgrading using the command-line interface (CLI) 72
- software packages
  - listing 369
  - viewing 287
- splitvdiskcopy command 423
- SSH (secure shell)
  - client system
    - preparing to issue CLI commands 6
- SSH *See* secure shell 1
- SSH keys
  - creating 2
- startemail command 160
- startfcconsistgrp command 190
- startfcmap command 191
- startrcconsistgrp command 340
- startrcrelationship command 342
- startservice command 374, 379
- startstats command 123
- starttrace command 386
- stopcluster command 125
- stopemail command 161
- stopfcconsistgrp command 192
- stopfcmap command 194
- stopnode command 380
- stopping
  - FlashCopy mapping 31
- stoprcconsistgrp command 344
- stoprcrelationship command 345
- stopservice command 381
- stopstats command 127
- stoptrace command 386
- storage pools
  - creating using the CLI 19
- subnet mask
  - changing 61
- Summary of changes for GC27-2287-01 Command-Line Interface User's Guide xi
- svqueryclock command 137
- switchrcconsistgrp command 346
- switchrcrelationship command 347
- SYSLOG 68
- system log
  - information 68

## T

- t3recovery command 381
- testemail command 161
- time
  - setting clustered system using the CLI (command-line interface) 11
- time zones 287
- tracing commands
  - overview 383
  - setdisktrace 383
  - settrace 384
  - starttrace 386
  - stoptrace 386
- trademarks 513

- triggerenclosureddump command 175
- triggerlivedump command 314
- triggermddiskdump command 323

## U

- Updating
  - license
    - using the CLI (command-line interface) 12
- upgrading
  - software using the command-line interface (CLI) 72
- user groups
  - creating using CLI 65
  - modifying using CLI 65
- user management commands
  - chauthservice 387
  - chcurrentuser 389
  - chuser 390
  - chusergrp 391
  - mkuser 392
  - mkusergrp 393
  - overview 387
  - rmuser 394
  - rmusergrp 394
- users
  - creating 7
  - creating using CLI 66
  - modifying using CLI 66

## V

- validating
  - volume copies 45
- VDisk (virtual disks)
  - determining mappings 42
- VDisk Mirroring
  - memory 23
- VDisks (virtual disks)
  - determining name of 41
  - expanding 50
- VDisks *See* virtual disks 397
- viewing
  - clusters 206
  - Global Mirror
    - consistency groups 271
    - relationships 274
  - I/O groups 235
  - Metro Mirror
    - consistency groups 271
    - relationships 274
- Viewing
  - license
    - using the CLI (command-line interface) 12
- virtual disk commands
  - expandvdisksize 404
  - lsrepairsevdiskcopyprogress 278
  - lsrepairvdiskcopyprogress 280
  - mkvdiskhostmap 413
  - recovervdisk 414
  - recovervdiskbycluster 415
  - recovervdiskbyiogrp 415
  - repairvdiskcopy 417
  - rmvdiskcopy 420

- virtual disk commands (*continued*)
  - shrinkvdisksize 421
  - splitvdiskcopy 423
- virtual disks
  - removing 420
- virtual disks (VDisks)
  - determining mappings 42
  - determining name of 41
- virtual disks commands
  - overview 397
- vital product data (VPD)
  - listing 367
  - viewing 264
- volume
  - copying 397
  - creating 24
  - deleting a copy 28
  - expanding 51
  - managed disks (MDisks)
    - relationships 42
  - MDisks (managed disks)
    - relationships 42
  - migrating 44, 55
  - shrinkvdisksize command 52
  - viewing FlashCopy mappings 302
- volume commands
  - addvdiskcopy 397
  - chvdisk 401
  - lscontrollerdependentvdisks 215
  - lssevdiskcopy 282
  - lsvdiskcopy 296
  - lsvdisksyncprogress 307
  - mkvdisk 406
  - repairsevdiskcopy 416
  - rmvdisk 418
  - rmvdiskhostmap 420
- volume copies
  - validating 45
- volume extent
  - viewing 300
- volume) 51
- volumes
  - adding a copy 27
  - converting
    - from image mode to managed mode 56
  - creating 406
  - listing node dependent 40
  - recovering 48
  - recovering from offline
    - using CLI 47
    - using the CLI 48
  - viewing 291
  - viewing disks 304

## W

- writesernum command 138





Printed in USA

GC27-2287-01

